

MAXZEN

地上・BS・110度CS 4K液晶テレビ

JU50TS01

取扱説明書



HDMI端子 4系統
LEDバックライト搭載

この度はMAXZENをお買い上げいただき、誠にありがとうございます。

本製品を安心してお使いいただくために、必ずこの取扱説明書をよくお読みください。

この取扱説明書は、大切に保管していただき、不明点がある場合にご活用ください。

安全上の注意

表示について

お使いになる人や他の人への危害、財産への損害を未然に防止するため、必ずお守りいただくことを、次のように説明しています。

■表示内容を無視して、誤った使いかたをした時に生じる危害や損害の程度を、次の表示で区分し、説明しています。



警告

この表示の欄は、「死亡または重傷などを負う可能性が想定される」内容です。



注意

この表示の欄は、「傷害を負う可能性または物的損害のみが発生する可能性が想定される」内容です。

■お守りいただく内容の種類を、次の絵表示で区分し、説明しています。(下記は絵表示の一例です。)



このような絵表示は、してはいけない「禁止」内容です。



このような絵表示は、必ず実行していただく「強制」内容です。



警告



禁止

絶対に分解したり、修理・改造をしないでください。
発火したり、異常動作して、火災や感電・けがの原因になります。



禁止

通風孔や穴などにピンや針金など金属製のものを入れないでください。
発火したり、異常動作して、火災や感電・けがの原因になります。



強制

異常・故障時は、すぐに使用を中止し、電源プラグを抜いてください。
発火したり、異常動作して、火災や感電の原因になります。お買い上げの販売店、またはご相談窓口へ連絡してください。



禁止

浴室や水のかかりやすい場所、湿気が多い場所に設置しないでください。
漏電による火災・感電の原因になります。



強制

壁掛け工事は専門業者に依頼してください。
壁掛け工事が不完全ですと、落下しけがの原因になります。



禁止

水をかけないでください。
テレビの中に水などが入ると、火災・感電の原因になります。



禁止

テレビを落としたり、キャビネットを破損した時は使用しないでください。
火災・感電の原因になります。



禁止

上にものを置いたり、ペットをのせたりしないでください。
金属類や、花びん・コップ・化粧品などの液体、ペットの尿・体毛などが内部にはいった場合、火災・感電の原因となります。重いものなどが置かれて落下した場合、けがの原因となります。

安全上の注意 (つづき)

警告



禁止

電源コードに重いものを乗せたり、熱器具に近づけたり、無理に引っ張らないでください。
コードが破損して、火災・感電の原因になります。



禁止

本機に付属されている電源コードを他の機器に使用しないでください。
他の機器に使用すると、火災・感電の原因となることがあります。



禁止

電源コード・電源プラグは、傷つけたり、延長するなど加工したり、加熱したり（熱器具に近づけるなど）しないでください。
火災・感電の原因になります。



強制

電源プラグの刃と刃の間に付いたホコリは、定期的に乾いた布で拭き取ってください。
火災・感電の原因になります。



禁止

雷が鳴り出したら、テレビ・電源コード・アンテナ線および本機に接続した機器やケーブル・コードに触らないでください。
感電の原因になります。



強制

電源は、交流100Vを使ってください。
交流100V電源以外で使用すると、火災・感電の原因になります。



禁止

ぬれた手で電源プラグを抜き差ししないでください。
感電の原因になります。



強制

包装に使用しているビニール袋でお子様が進んだりしないように注意してください。
かぶったり、飲み込んだりすると、窒息のおそれがあります。



禁止

不安定なテレビ台やキャスター付きの台、じゅうたんや布団のような柔らかいものの上など、不安定な場所に据え付けしないでください。

多くの傷害、特に子供に対しては、次のような簡単な予防措置を取ることで回避できます。

- テレビジョンセットメーカーが推奨するキャビネット又はスタンドを使用する。
- テレビジョンセットを安全に支持する専用の家具を使用する。
- テレビジョンセットが支持する家具の端から突き出さないようにする。
- 適切な支持物に家具及びテレビジョンセットの両方を固定することなく、背の高い家具（食器棚、本棚など）にテレビジョンセットを置かない。
- テレビジョンセットと支持する家具との間に、布又は他の材質のものを敷かない。
- テレビジョンセット又はその制御器に触れるために、家具によじ登ることの危険性を子供に教育する。



強制

お手入れのときは、電源プラグをコンセントから抜いてください。
感電の原因となることがあります。



強制

本機はコンセントから電源プラグが抜きやすいように設置してください。
万一の異常や故障のとき、または長期間使用しないときなどに役立ちます。

安全上の注意 (つづき)

⚠ 注意



禁止

直射日光の当たる場所やストーブのそばなど、温度の高い場所に置かないでください。
火災の原因となることがあります。また、キャビネットの変形や破損などによって、感電の原因となることがあります。



禁止

湿気・油煙・ホコリの多い場所に置かないでください。
加湿器・調理台のそばや、ホコリの多い場所などに置くと、火災・感電の原因となることがあります。



禁止

通風孔をふさがないでください。壁に押しつけないでください。風通しの悪い所に押し込まないでください。(10cm以上の間隔を空けてください)
通風孔をふさぐと内部に熱がこもり、火災の原因となることがあります。



禁止

電源プラグを抜くときは、電源コードを引っ張って抜かず、プラグを持って抜いてください。
電源コードを引っ張って抜くと、電源コードや電源プラグが傷つき火災・感電の原因となることがあります。



禁止

液晶テレビの画面をたたいたり、衝撃を加えたりしないでください。
ガラスが割れて、けがの原因となることがあります。もしも、ガラスが割れて液晶(液体)がもれたときは、液晶に直接触れないで、拭き取ってください。もれた液が目にはいたり、皮膚についたときは、きれいな水でよく洗い流し、直ちに医師に相談してください。



禁止

コンセントや配線器具の定格を超える使いかた、タコ足配線をししないでください。
火災・感電の原因となることがあります。



強制

旅行などで長期間使用しないときは、安全のため電源プラグをコンセントから抜いてください。
万一故障したとき、火災の原因となることがあります。



強制

ヘッドホンやイヤホンを使用するときは、音量は徐々に上げてください。
突然大きな音が出て耳をいためることがあります。



強制

1年に一度は通風孔がホコリなどで詰まっていないか確認してください。
本機の内部にホコリがたまったまま使用すると、火災や故障の原因となることがあります。湿気の多くなる梅雨期の前に行うと効果的です。

⚠ リモコンに使用する乾電池に関する警告・注意



禁止

- 指定以外の乾電池は使用しないでください。
- ⊕ ⊖ 極性表示を間違えて挿入しないでください。
- 充電・加熱・火への投入・分解したり、ショートさせたりしないでください。
- 長期間使用しないときは、乾電池をリモコンに入れておかないでください。液漏れにより、リモコンの故障の原因になります。
- 液漏れがあった場合は、液に触れないでください。
もしも液が目や口に入ったり、皮膚についたときは、きれいな水でよく洗い流し、直ちに医師の診断を受けてください。
- 電池は、金属性のボールペン、ネックレス、コイン、ヘアピンなどと一緒に携帯、保管しないでください。
- 電池を廃棄するときは、地方自治体の指示に従ってください。
- 電池は日光、火などの過度の熱にさらさないようにして下さい。

使用上の注意

- 本製品を横倒しにして輸送した場合、液晶パネルの破損や画面欠点の増加の恐れがあります。横倒しでの輸送をしないでください。運ぶときは、傷がつかないように毛布などでくるんで衝撃・振動を与えないでください。
- 通風孔をふさがないでください。通風孔をふさぐと内部に熱がこもり、火災の原因となることがあります。風通しの悪い場所(棚や押入れの中など)や、じゅうたんや布団の上に置かないでください。また布をかけたりしないでください。定期的に掃除機で通風孔にたまったごみを除去してください。
- 液晶パネルには、画面の一部に暗点(光らない点)や輝点(余計に光る点)がある場合があります。これは故障ではありません。
- 本機を長時間使用したときに、液晶パネル表面や本機上部が熱くなる場合があります。熱く感じる場合でも、故障ではありません。
- 本機から「ジー」という液晶パネルの駆動音が聞こえる場合がありますが、故障ではありません。
- テレビ放送、外部入力のソースによっては、映像や音声に若干の遅れが生じる場合があります。映像、音声でリズムを取るテレビゲームやカラオケによっては、違和感を感じる場合がありますが、故障ではありません。
- 電源プラグは長期間ご使用にならないとき以外は、常時コンセントに接続してください。(番組情報を取得するためです)
 - 電源プラグをコンセントから抜く場合、電源プラグを抜いている間に録画予約がないか確認してください。電源プラグが抜かれていると、予約した番組は録画されません。
- リモコンを落としたり、踏んだり、リモコンに液体をかけたりしないように、ていねいに扱ってください。直射日光が当たるところ、暖房器具のそばや湿度が高いところには置かないでください。
- ケーブルテレビ、・共聴・集合住宅設備で放送を受信する場合は、事業者または管理者にアンテナの接続方法についてお問い合わせください。
- 本機を廃棄処分する場合や他人に譲渡したりする場合、「すべての初期化」を実行していただき、設定をお買い上げ時の状態に戻し、個人情報の消去を行ってください。
- あなたが録画・録音したものを個人的にまたは家庭内その他これに準ずる限られた範囲内で楽しむ以外に権利者の許諾なく、複製・改変したり、インターネットなどで送信・掲示したりすることは著作権法上禁止されています。以下の行為も、著作権法上保護された権利を侵害することになりますのでご注意ください。
 - 録画した番組を自分のホームページで見られるようにする。
 - 録画した番組をメールやメッセージサービスなどで他人に送る。
 - 番組を録画したビデオテープやディスクなどの媒体を営利の目的で、または不特定もしくは多数の人に貸す。著作権法に違反すると刑事処罰を受ける場合もありますので自己責任の基でご利用ください。なお、著作権法違反によって生じた損害に関して、当社は一切の責任を負いません。
- 他の接続機器との組合せによる誤動作や動作不能、誤操作などから生じた損害(録画機器などの故障、録画内容の変化・消失など)に関して、当社は一切の責任を負いません。
- 誤操作や、静電気などのノイズによって本機に記憶されたデータなどが変化・消失することがあります。これらの場合について、当社は一切の責任を負いません。
- 取扱説明書の記載内容を守らないことによって生じた損害に関して、当社は一切の責任を負いません。

各部名称 / JU50TS01

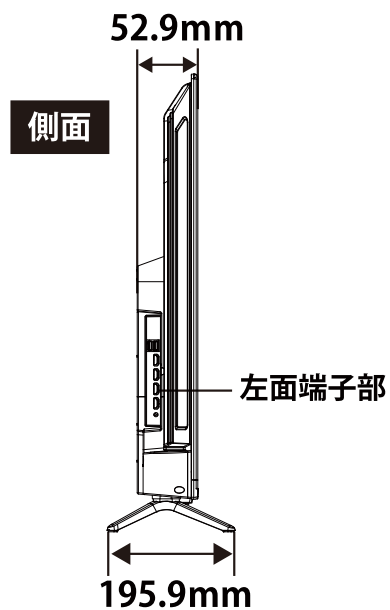
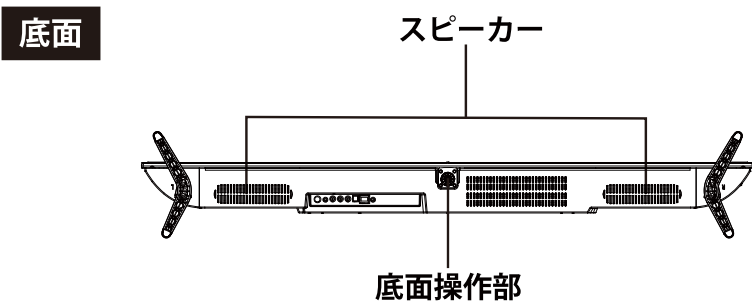
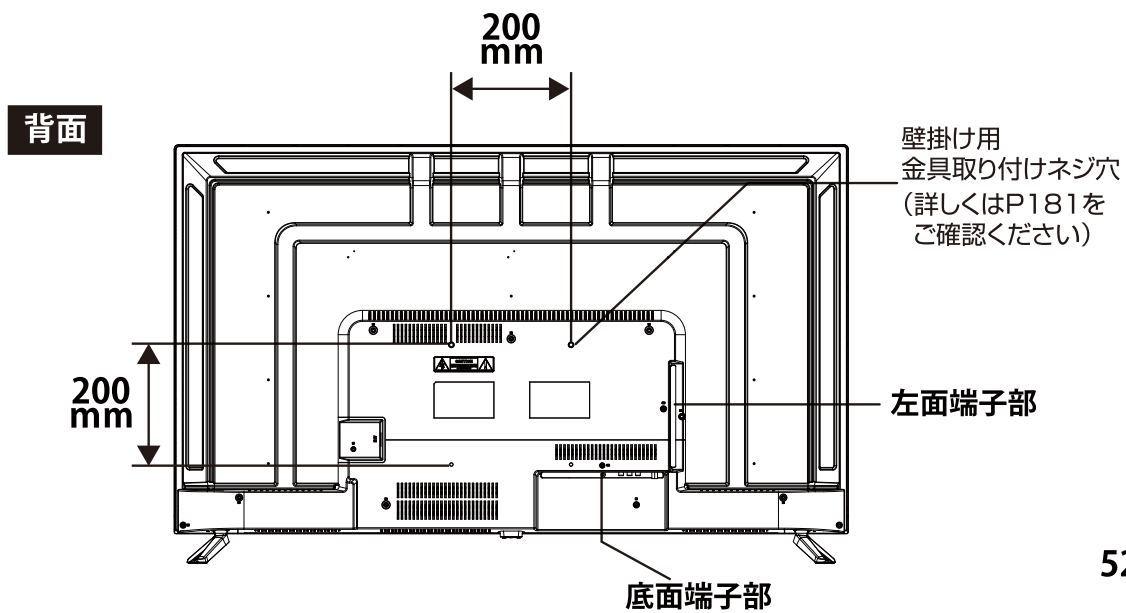
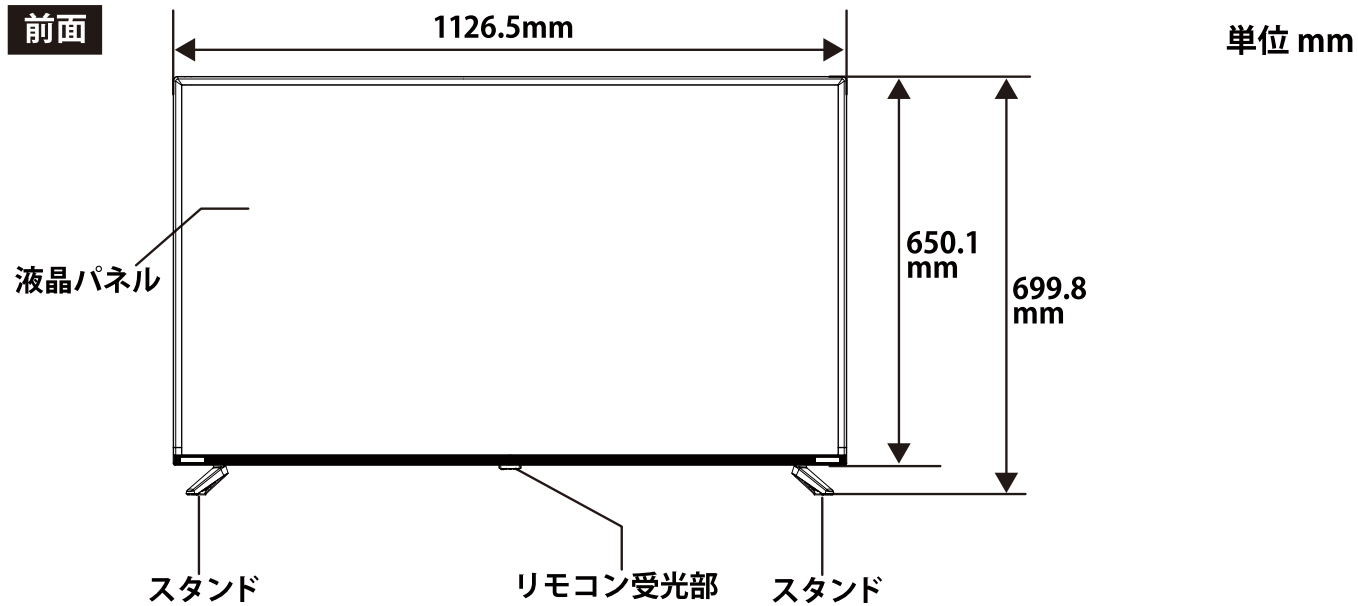

各部名称 (つづき)

底面端子部

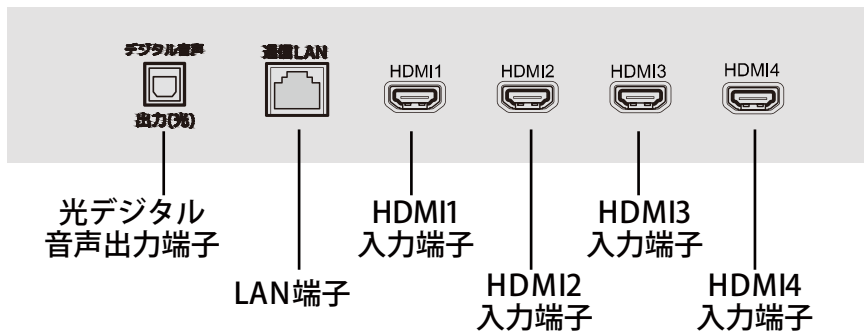

左面端子部

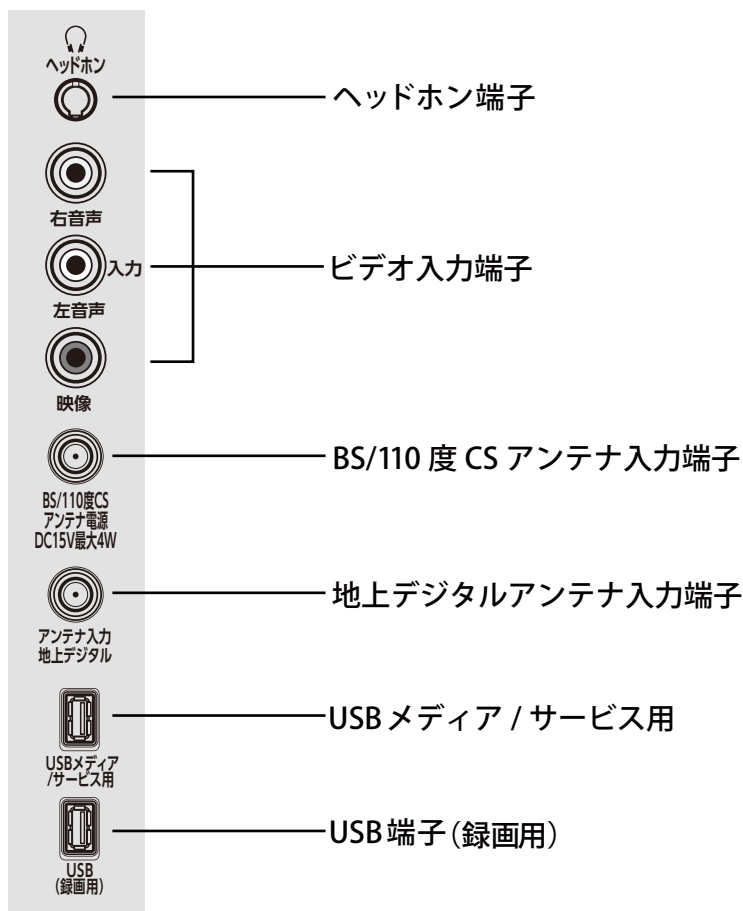

背面操作部

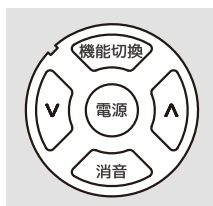

- 電源：電源を切/入します。
- 機能切換：機能を切り換えます。
- 消音：音量を消します。
- ▲：音量(大)ボタン
- ▼：音量(小)ボタン

リモコン



スタンドを取り付ける



注意

- 梱包材からテレビ本体を出す際に注意する。
- 画面を強く握らない 画面を強く握ると、液晶パネルが割れるおそれがあります。

- テレビ本体を横に寝かせてからスタンドを取り付けます。
- テレビ本体よりも大きいテーブルがある場合は、テーブルの上に毛布などの柔らかい布を敷いて、作業台とすることができます。

- 付属されているスタンド、ネジをご確認ください。
- スタンド取り付け作業時は、作業に十分なスペースを確保してください。
- プラスドライバー（JIS）をご用意ください。
- 製品についている保護フィルムなどは設置作業完了後に取りはずすようにしてください。

JU50TS0

A

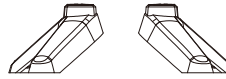

×2

B

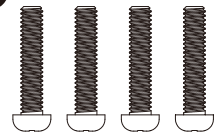

×4

1. テーブルなどの台の上に毛布などのやわらかい布を敷き、その上に液晶画面を下向きにして本機を置く
2. スタンドを固定する、本体の穴の位置に合わせ付属のネジで固定します

スタンド固定イメージ

JU50TS0

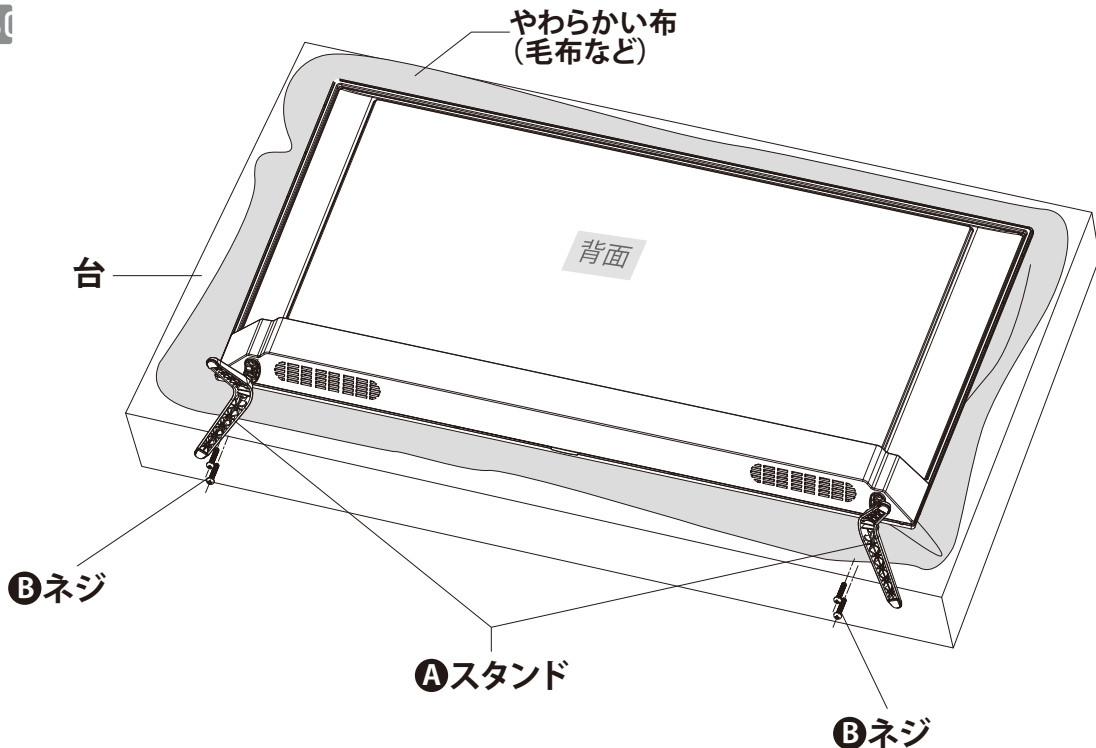

液晶パネルを傷つけないよう取り扱いにご注意ください。

もくじ

準備をする

「はじめての設定」をする	8
「はじめての設定」について	8
「はじめての設定」の流れ	8
はじめての設定	8
① 地域設定	8
② 地上デジタルチャンネル設定	9
③ BS・110度CSアンテナレベル確認	10
④ 映像メニュー設定	10
「はじめての設定」をやり直すとき	10

テレビを見る

テレビ番組を楽しむ	11
リモコンで番組を選ぶ	11
音量を調節する / 音を一時的に消す / 字幕を表示させる	12
操作ガイドについて	13
サブメニューについて	14
番組情報や番組説明を見る	15
番組情報を見る	15
番組説明を見る	15
番組表で番組を探す	16
番組表を使う	16
番組を見ながら他の番組を探す (ミニ番組表)	17
番組表を便利に使う	18
条件を絞りこんで番組を探す	23
データ放送やラジオ放送を楽しむ	26
連動データ放送を楽しむ	27
独立データ放送やラジオ放送を楽しむ	27
便利な機能を使う	29
画面サイズについて	29
画面サイズを切り換える	31
降雨対応放送について	32
他の映像・音声を切り換える	32
映像を静止させる	33

接続機器の情報を表示させる	34
省エネ設定をする	34
ヘッドホンで聴く	35
外部スピーカーで聴く	36
時計を表示する	36
自動で電源が入るようにする	36
自動で電源が切れるようにする	37
文字を入力する	38

録画機器を使う

録画機器の準備をする	41
録画・予約機能について	41
録画できる機器と番組	41
接続・設定と録画前の準備	41
USB ハードディスクの接続をする	42
USB ハードディスクの設定をする	43
USB ハードディスクを本機に登録する	43
USB ハードディスクの設定をする	44
録画の基本的な設定をする	46
録画に使用する機器を設定する	46
チャプター分割のしかたを設定する	47
録画・予約をする	47
見ている番組を録画する	47
番組表で予約をする	48
メッセージが表示された場合	49
マルチ表示の番組表で予約するとき	49
連続ドラマを予約する	50
日時を指定して予約をする／番組を検索して録画・予約をする	51
日時を指定して予約をする	51
番組を検索して録画・予約をする	52
録画予約や連ドラ予約の設定を変更するとき	52
予約の確認・変更・取り消しをする	54

予約・録画の優先順位と予約の動作について	55
予約・録画の優先順位について	55
予約の動作について	56
再生する	57
録画した番組を再生する	57
再生の基本操作とさまざまな再生のしかた	57
録画番組の再生中にできるリモコン操作	59
録画番組の情報や番組説明を見る	60
録画番組を修復する	60
見たい録画番組を探して再生する	61
録画リストのさまざまな機能を使う	62
繰り返し再生の設定を変える	62
番組を並べ替える	63
ほかの機器を選択する	63
連ドラ予約をする	63
機器の情報を確認する	63
不要な録画番組を消す／誤って消さないように保護する	64
一つの録画番組を消す	64
複数の録画番組を消す	64
グループ内の録画番組をすべて消す	64
自動的に消す（自動削除設定）	65
誤って消さないように保護する	65
編集・ダビングする	65
チャプター編集をする	65
録画済番組の再生中に編集する	65
グループ名を変更する	66
ほかのグループに移動する	67
録画番組をダビング（ムーブ）する	68
USBハードディスク間でムーブする	68

接続機器を使う

外部機器を接続する	69
外部機器接続例	69
アナログ音声入力端子付のオーディオ機器で聴くとき	71
デジタル音声（光）端子付のオーディオ機器で聴くとき	72
HDMI 連動対応のオーディオ機器で聴くとき	73
外部入力の機能を設定する	74
入力切替時に画面に表示される機器名を設定する	74
使用しない外部入力をスキップする	75
HDMI モードを変更する	75
Dolby Digital Plus の入力を設定する	75
HDMI 入力の RGB レンジを設定する	76
ビデオ入力の音声入力を設定する	76
USB 機器を接続する	76
機器の接続時に操作メニューが表示されるようにする	77
HDMI 連動について	78
HDMI 連動機能でできること	78
HDMI 連動機能について	79
本機のリモコンで HDMI 連動機器を操作するための設定をする	79
外部入力の画面に切り換える	82
本機のリモコンで対応機器を操作する	83
機器を操作する	83
本機のリモコンでできるおもな操作	85
オーディオ機器（サウンドシステム）で聴く	86
オーディオ機器のスピーカーで聴く	86
動画を再生する	87
動画再生の操作	87
動画再生時に出来るリモコン操作	89
動画の再生方法を設定する	90
時間を指定して再生する（タイムサーチ）	90
動画を並べ替える	90
機器を選びなおす	90
動画再生リストの操作ガイドについて	90

写真を再生する	91
写真再生の操作	91
マルチ表示画面の表示モードを切り換える	93
再生を繰り返す	93
スライドショーの表示間隔の設定をする	94
マルチ表示画面の写真の並べ順を変える	94
機器を選び直す	94

インターネットに接続する

インターネットを利用するための接続をする	95
本機をインターネットに接続したときにできること	95
接続のしかた	95
インターネットを利用するための設定をする	97
アドレス設定 (IPv4)	97
IPv6 接続	98
アドレス設定 (IPv6)	98
ネットワーク情報	99
接続テスト	99
ネットワーク設定の接続テスト結果について	100

調整・設定をする

映像を調整する	102
お好みの映像メニューを選ぶ	102
お好みの映像に調整する	103
黒レベル	104
色の濃さ	104
色あい	104
精細感・ノイズ調整	104
コントラスト感調整	105
色温度	106
映像調節を初期値に戻す	106

音声を調整する	107
お好みの音声メニューを選ぶ	107
お好みの音声に調整する	108
低音強調	108
イコライザー	108
サラウンド	109
オートボリューム	109
左右バランス	109
ドルビー DRC	109
音声出力詳細設定	109
その他の設定をする	112
アンテナを調整する	112
電波の強さ（信号強度）を確認する	112
アンテナを調整する	113
BS・110度CS用アンテナ電源供給の設定を変更する	114
アンテナ線がショートしたとき	114
チャンネルを追加したり設定を変更したりするとき	115
地上デジタルチャンネルを自動で設定する	115
視聴しないチャンネルをスキップする	116
データ放送の設定をする	117
地域と郵便番号を設定する	117
災害発生時に文字情報を表示させる	117
ルート証明書の番号を確認する	118
視聴できる番組を制限する	119
制限するために暗証番号を設定する	119
番組の視聴を制限する	120
お買い上げ時の設定に戻すには（設定内容を初期化するには）	121

さまざまな情報

ソフトウェアを更新する	122
ソフトウェアの更新機能について	122
ソフトウェアの自動ダウンロードについて	122
ソフトウェアのバージョンを確認するには	122
お知らせを見る	124
ACAS チップ情報を確認する	125
対応フォーマット	126
本機で対応している HDMI 入力信号フォーマット	126
本機で再生できる 動画のフォーマット	126
本機で再生できる写真（静止画ファイル）のフォーマット	126
アイコン一覧	127
番組についてのアイコン	127
お知らせ、予約、その他についてのアイコン	128

その他

ライセンスおよび商標などについて	129
本機で使われるソフトウェアのライセンス情報	130

困ったときは

こんな場合は故障ではありません	176
症状に合わせて解決法を調べる	176
テレビが操作できなくなったとき	176
操作	177
映像	177
音声	178
地上デジタル放送	178
BS・110度CS デジタル放送	179
番組表	179
お知らせアイコンが消えない	179
録画・再生	180
壁掛けでご使用になるとき	181
主な仕様	182
保証とアフターサービス	184

「はじめての設定」をする

「はじめての設定」について

※「電波の状態が良くありません。」のメッセージが表示されたときは、受信状態が良くなってから「はじめての設定」をやり直すとき（P.10）の操作で「はじめての設定」をやり直してください。

「はじめての設定」の流れ

● 本機を使用できるようにするための基本的な設定をします。

① 地域設定

地域と郵便番号を設定することで、お住まいの地域に密着したデータ放送（たとえば、地域の天気予報など）や緊急警報放送を視聴できるようになります。

② 地上デジタルチャンネル設定

お住まいの地域情報を設定することで、地上デジタル放送の受信チャンネルが自動設定されます。

③ BS・110度CSアンテナレベル確認

衛星放送の電波の強さを確認します。

④ 映像メニュー設定

いくつか用意されている映像メニューの中から選んで、お好みのメニューに設定します。

はじめての設定

① 地域設定

● お住まいの地域に密着したデータ放送（たとえば、地域の天気予報など）や緊急警報放送を視聴できるようになります。

1、お住まいの地方を▲・▼・◀・▶で選び、決定を押す

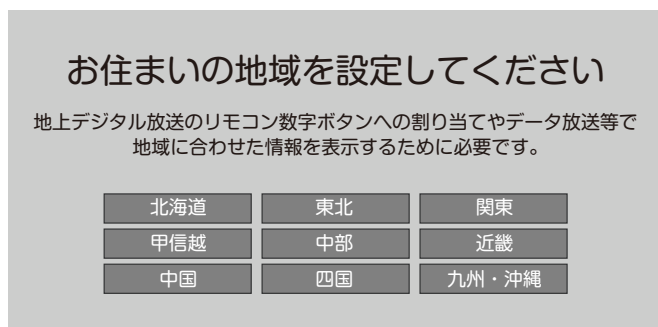

2、お住まいの都道府県を▲・▼・◀・▶で選び、決定を押す

3、お住まいの地域の郵便番号を 1 ～ 10 で入力し、決定 を押す

- 「0」は10で入力します。
- 間違えて入力したときは、◀を押してカーソルを戻してからもう一度入力します。
- 郵便番号入力で、上3ケタを入力して決定を押すと残りの4ケタは自動的に「0」が入力されます。

例

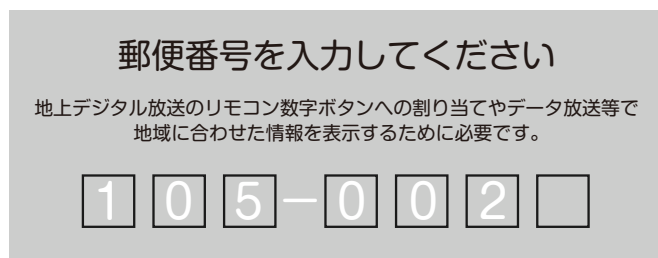

- 「地域設定」が終わると、「地上デジタルチャンネル設定」の画面が表示されます。

② 地上デジタルチャンネル設定

- 地上デジタル放送のチャンネルを設定します。同時にデータ放送の地域も設定されます。

1、画面の説明を読み、◀・▶で「はい」を選んで、決定 を押す。

※ お住まいの地域で地上デジタル放送が運用されていない場合は、「いいえ」を選んで「③BS・110度CSアンテナレベル確認」に進みます。(わからない場合は、「はい」を選びます)

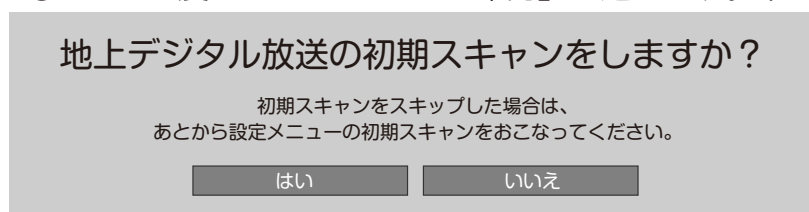

- 「はい」を選ぶと初期スキャンが自動的に始まります。終了すると、手順2の画面が表示されます。

2、地上デジタルチャンネルの設定内容を確認し、決定 を押す

- 画面は、リモコンのワンタッチ選局ボタンに設定された地上デジタル放送の放送局を一覧で示しています。

例



- 「地上デジタルチャンネル設定」が終わると、「BS・110度CSアンテナレベル確認」の画面が表示されます。

「はじめての設定」をする

③ BS・110度CSアンテナレベル確認

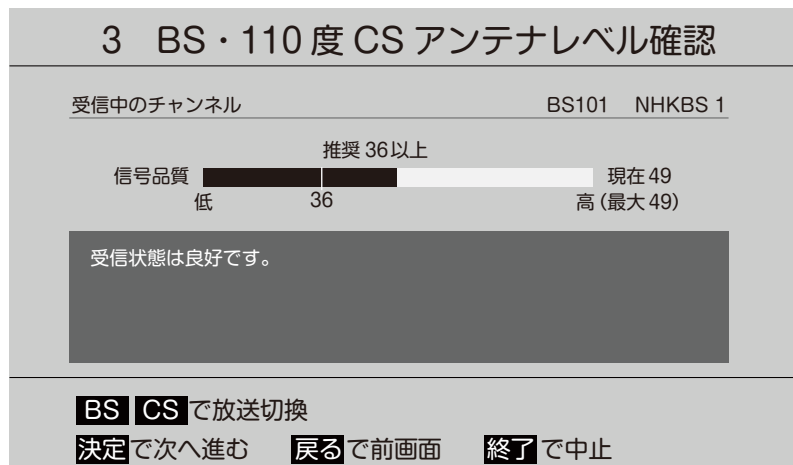

- 衛星放送の電波の強さを確認します。
1、アンテナの受信状態を確認し、決定 を押す
- 「BS・110度CSアンテナレベル確認」が終わると、「映像メニュー設定」の画面が表示されます。

④ 映像メニュー設定

- 本機にはいくつかの「映像メニュー」が用意されています。
メニューを選択したときに表示される画面の説明を読んで、お好みの映像メニューに設定してください。

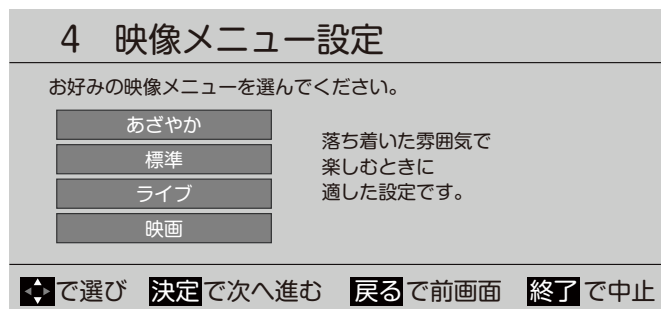

- 1、お好みの映像メニューを▲・▼で選び、決定 を押す
- 2、設定完了画面が表示されたら内容を確認して 決定 を押し、はじめての設定を終了する

お知らせ・・

■「地上デジタルチャンネル設定」について

- 「はじめての設定」または「初期スキャン」(P.115) をすることで、地上デジタル放送の受信可能なチャンネルを本機が探し、リモコンの1～12に自動設定します。(「はじめての設定」または「初期スキャン」をしないと、地上デジタル放送は受信できません)

■ 地方と地域の設定について

- チャンネルの自動設定は、「はじめての設定」で設定された地方、地域に基づいて行われます。
- チャンネル設定の地域は必ずしもお住まいの地域とは限らないため、地域に密着したデータ放送を視聴するために郵便番号を設定します。

「はじめての設定」をやり直すとき

- 「はじめての設定」をしてもアンテナ接続の不具合などで地上デジタル放送が映らなかった場合は、不具合の対処をしたあとで、「はじめての設定」をやり直すことができます。
- 1、設定 を押し、▲・▼と 決定 で「初期設定」⇒「はじめての設定」の順に進む
 - 「はじめての設定」の説明画面が表示されます。
 - 2、画面の説明を読んで、決定 を押す
 - データ放送を視聴している状態で「はじめての設定」をやり直した場合、放送によっては設定終了後そのままの状態では設定内容は反映されません。設定終了後に再度データ放送を選局してください。

テレビ番組を楽しむ

リモコンで番組を選ぶ



1、地デジ、BS、CS、4K で放送の種類を選ぶ

- 今見ている放送と同じ種類の放送を見る場合は、この操作は不要です。

2、チャンネルを選ぶ（選局する）

- 以下の3とおりの選局方法があります。

ワンタッチ選局ボタンで選局する（ワンタッチ選局）

- ワンタッチ選局ボタン 1～12 で選局します。（P.12 の「お知らせ」をご覧ください）
- BS デジタル放送・110度 CS デジタル放送・BS/CS 110度 4K 放送のワンタッチ選局は、グループを指定して選局することができます。
 - ・通常はグループ A のワンタッチ選局になります。
- グループを指定して選局する
- 見ている放送と同じ種類の放送切換ボタンを押すと、選局ガイドが表示されます。
 - 例：BS デジタル放送を見ているときに BS を押すと、BS デジタル放送の選局ガイドが表示されます。
- 選局ガイドを表示中に見ている放送と同じ種類の放送切換ボタンを押すと、選局ガイドに表示されるグループが切り換わります。
 - ・BS デジタル放送は、グループ A (BS101 (NHKBS1)～BS222 (BS12 トゥエルビ)) とグループ B (BS231 (BS キャンパス ex)～BS256 (ディズニーチャンネル)) があります。
 - ・BS・110度 CS 4K 放送は、グループ A とグループ B があります。
 - ・110度 CS デジタル放送は、グループ A～グループ F があります。
- 1～12 ボタンを押すと、選局ガイドに表示されているチャンネルに切り換わります。

チャンネルハーフボタンで選局する（順次選局）

- チャンネルでチャンネルが順次に切り換わります。

チャンネル番号を入力して選局する（ダイレクト選局）

- チャンネル番号は番組表で確認できます。

① サブメニュー を押し、▲・▼と 決定 で「チャンネル番号入力」と進む。

視聴中の放送の種類に応じて、画面の右上に [地デジ ---]、[BS ---]、[CS ---]、[BS/CS4K ---]、のどれかが表示されます。

② 1～10 (0) でチャンネル番号を入力する

例 103 チャンネルを選ぶ場合⇒ 1 10 (0) 3 の順に押します。（「0」は 10 で入力）

・入力した番号を消すには、◀を押します

・11(*)を使った入力ができます。例 3 11 →300 番以降の最小チャンネル

テレビ番組を楽しむ (つづき)

■ 枝番のついた放送一覧が表示されたとき

- ・▲・▼で選んで決定を押すか、10 (0) ~ 9 で枝番を指定して選びます。



お知らせ.....

- 視聴できるデジタル放送のチャンネルやワンタッチ選局ボタンの番号は、番組表 (P.16) で確認することができます。
- 1 ~ 12 でワンタッチ選局ができるのは以下のとおりです。
 - ・ 地デジ を押したとき→「はじめての設定」(P.8) で各ボタンに登録されたチャンネル
 - ・ BS、4K を押したとき→各ボタンにあらかじめ登録されているチャンネル
 - ・ CS を押したとき→110 度 CS デジタル放送の一部のチャンネル (1 と 2 だけ)
- ◆ 一つの放送局が複数のチャンネルで異なった番組を放送している場合、その放送局のチャンネルボタンを繰り返し押せばチャンネルを順番に選局できます。
- 枝番のついた放送一覧は、地上デジタル放送で隣接地域の同じチャンネル番号の放送を複数受信できたときに表示されます。
- 視聴制限のある番組の視聴には視聴制限設定が必要です。詳しくは「視聴できる番組を制限する」(P.119) をご覧ください。

音量を調節する / 音を一時的に消す / 字幕を表示させる



音量を調節する

- ① リモコンの + 音量 - を押す

音を一時的に消す

- ① リモコンの 消音 を押す
 - 画面右下に [消音] が表示されます。もう一度 消音 を押すと音が出ます。

字幕放送番組で字幕の表示 / 非表示を切り換える

- ① 字幕 を押す

サブメニューから切り換えるには

- ① サブメニュー を押し、▲・▼と 決定 で「字幕」を選ぶ
- ② ▲・▼で「字幕オン」か「日本語字幕」または「字幕オフ」を選び、決定 を押す

操作ガイドについて

- 番組表や操作画面などには、そのときに使用できる（または使用する）リモコンボタンの操作ガイドが表示されます。
- よく使う機能がカラーボタン（青、赤、緑、黄）やサブメニューに割り当てられています。

例 録画リスト

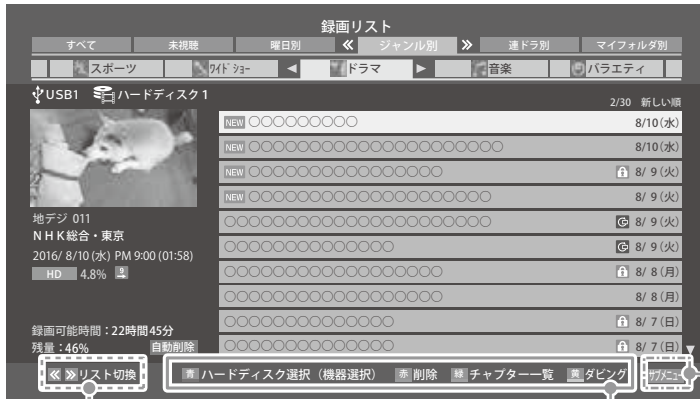

サブメニュー の表示
サブメニューがあることを示します。

例 番組表

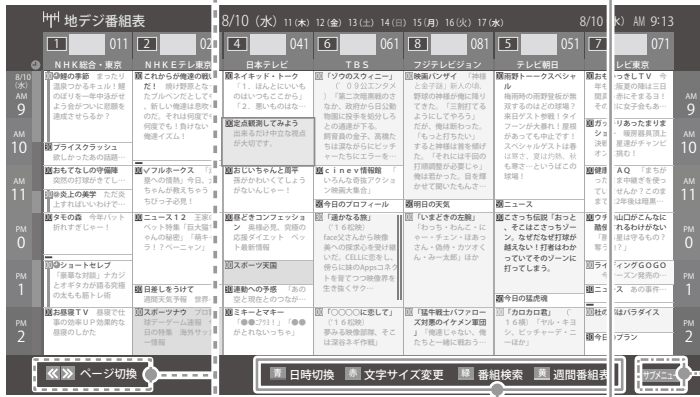

青 赤 緑 黄 の表示
カラーボタンでさまざまな操作ができることを示します。

例 操作画面

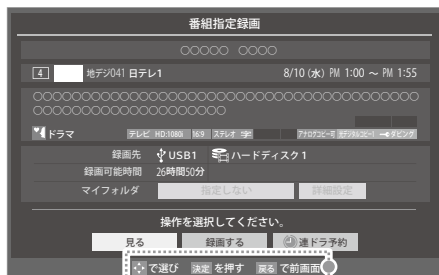

◀ ▶ の表示
ページやリストの切り換えができることを示します。

決定 戻る の表示
選んで決定したり、前の画面に戻ったりすることができることを示します。

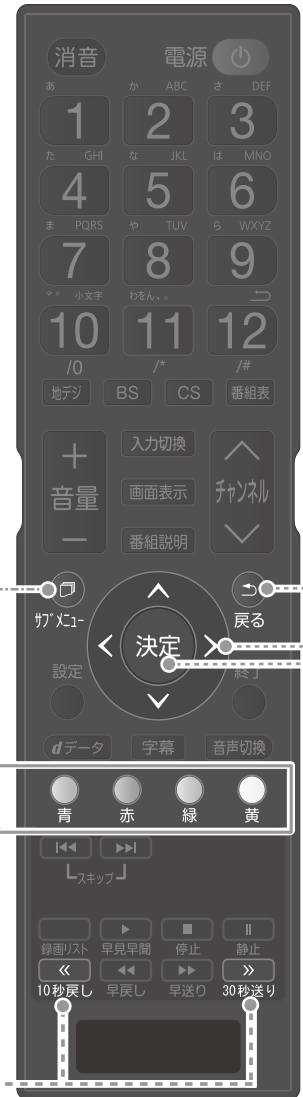

テレビ番組を楽しむ (つづき)

サブメニューについて

- サブメニュー を押してサブメニューを表示させ、さまざまな便利機能を使うことができます。
- サブメニューの内容は、サブメニュー を押すときの場面によって変わります。
- サブメニューで選択できる項目は、放送の種類や外部機器の有無などによって変わります。選択できない項目は、薄くなって表示されます。

例 デジタル放送のテレビ番組を視聴中

サブメニュー	機能 (一部省略しています)	詳細記載ページ
番組説明	視聴中の番組の詳しい情報を確認できます。	(P.15)
録画	録画ができます。	(P.47)
連ドラ予約	視聴中の連続ドラマが毎回録画されるように予約することができます。	(P.50)
予約リスト	予約リストを表示します。	(P.54)
メディアプレーヤー	動画、写真を再生するメディアプレーヤーを起動します。	(P.87)
時計	時計表示やオンタイマー / オフタイマーの設定ができます。	(P.36)
字幕	字幕放送番組で字幕の表示 / 非表示を切り換えられます。	(P.12)
画面サイズ切換	見ている映像の種類に応じて、画面サイズを切り換えることができます。	(P.31)
スピーカー切換	テレビのスピーカーで聴くか外部システムのスピーカーで聴くか選べます。	(P.36)
チャンネル番組入力	チャンネル番号を入力して選局します。	(P.11)
その他の操作		
信号切換		
アンテナレベル表示	映りが悪いときなどに、アンテナレベルを確認できます。	(P.112)
データ放送終了	データ放送の視聴を終了します。	(P.26)
テレビ / ラジオ / データ切換	視聴する放送メディアを切り換えます。	(P.26)
親切ヘッドホン音量	親切モードでのヘッドホンの音量を調節することができます。	(P.35)
お知らせ	本機や放送局からのお知らせがあったときに内容を確認します。	(P.124)
本機の情報	本機のソフトウェアバージョンを確認します。	(P.122)
映像信号切換	一つの番組で複数の映像が送られている場合に切り換えられます。	(P.32)
音声切換	一つの番組で複数の音声が送られている場合に切り換えられます。	(P.32)
音多切換	二か国語放送など、音声多重放送の場合に聞きたい音声を選びます。	(P.32)
降雨対応放送切換	豪雨などの影響で降雨対応放送が行われた場合に切り換えられます。	(P.32)

番組情報や番組説明を見る

番組情報を見る

1、画面表示 を押す

- 現在視聴しているチャンネルや番組の情報が表示されます。(チャンネル以外の表示は数秒後に消え)
- 表示を消すには、もう一度 画面表示 を押します。
- 選局時には一部省略された状態で表示されます。

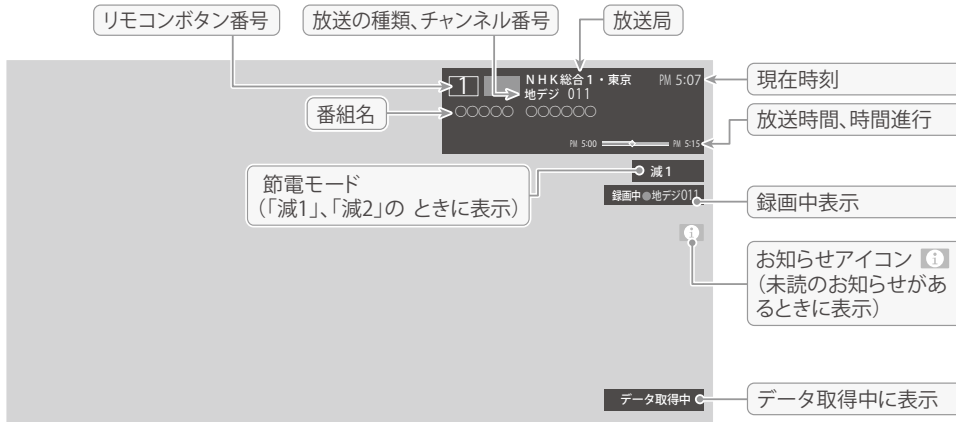

番組説明を見る

1、番組説明 を押す

- ・ サブメニュー を押し、▲・▼と 決定 で「番組説明」を選んでも同様の操作ができます。

2、さらに詳しい説明を見るときは▼を押す

- 「詳細情報を取得していません」が表示されたときは、黄 を押します。
 - ・ 詳細情報が取得できなかった場合には、「詳細情報を取得できませんでした」と表示されます。
 - ・ 詳細情報がなかった場合には、「番組の詳細情報はありません」と表示されます。

3、説明画面を消すには、決定 を押す



お知らせ

- 画面に表示されるアイコン ([ステレオ]、[HD:1080i]などの記号) についての説明は、「アイコン一覧」(P.127) をご覧ください。
- 番組情報の表示や詳細情報の取得には時間がかかることがあります。
- 番組情報を取得するタイミングによっては、最新の情報が表示されないことがあります。
- 番組によっては、録画、録音が制限されることがあります。その場合は、番組説明の画面でアイコンが表示されます。

番組表で番組を探す

番組表を使う

- 番組表は、放送電波で送られてくる番組情報を基にして表示されます。
- お買い上げ直後や電源を入れた直後、放送の種類を変えたときなどには、番組内容の表示に時間がかかることがあります。
- 番組表を最新にしておくために、本機の電源を毎日2時間以上「切」または「待機」にすることをおすすめします。
- 視聴年齢制限されている番組は、伏せ字（「****」）で表示されます。

1、番組表を押す

- 通常番組表が表示されます。
（「週間番組表」については「週間番組表を表示させる」（P.18）をご覧ください）
- 放送の種類を変えるときは、地デジ、BS、CS、4Kを押します。
- 独立データ放送やラジオ放送の番組表に切り換えるときは、サブメニューの「テレビ/ラジオ/データ切替」（P.22）で選びます。
- 番組表を消すときは、終了を押します。

2、▲・▼・◀・▶で番組を選ぶ

- 選んだ番組の番組説明を見るには、番組説明を押します。
- 番組表に表示しきれていないチャンネルを表示させるには◀・▶または◀・▶を押します。

3、決定を押す

- 現在放送中の番組を選んだときは、番組指定録画面が表示されます。
- これから放送される番組を選んだときは、番組指定予約画面になります。（P.48）の手順3をご覧ください。
- 視聴年齢制限されている番組を選んだときは、メッセージが表示されます。番組を見る場合は、決定を押し、1～10(0)で暗証番号を入力します。

4、現在放送中の番組を見るときは、▲・▼・◀・▶で「見る」を選び、決定を押す

- 画面の図は、現在放送中の番組でUSBハードディスクが接続されている場合の例です。

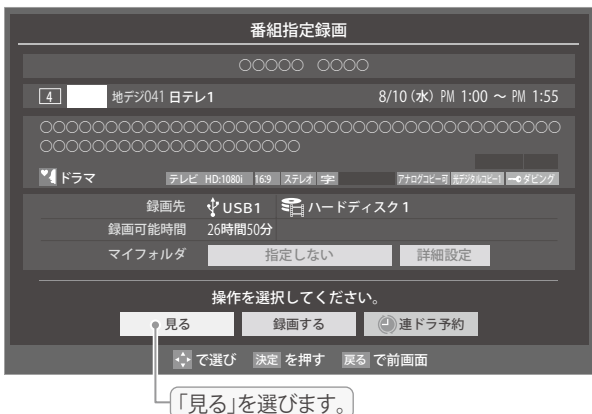

- 番組指定録画面からは、録画（P.47）、連ドラ予約（P.50）の操作ができます。
- 番組指定予約画面からは、視聴予約（P.48）、録画予約（P.48）、連ドラ予約（P.50）の設定ができます。

〔通常番組表画面：7チャンネル表示の例〕

放送の種類

リモコンボタン、チャンネル、放送局

録画予約がある時間帯 (赤色の縦線表示)

録画予約アイコン

視聴予約アイコン

連ドラ予約アイコン

別の番組がある時間帯 (灰色の二重縦線表示)

放送メディア(データ)

番組表の日付

現在の日時

選択中の番組

色分け設定をしたジャンルに該当する番組は、開始時刻と背景が設定した色になります。

放送時間の短い番組は、番組を選べば番組名などが表示されます。

リモコンボタンの操作ガイド

お知らせ

- テレビを視聴している条件などによっては番組表が空欄になることがあります。この場合は、空欄の部分を選んでから、「番組表を更新する」(P.19) の操作をしてください。
- 番組表に表示できる番組情報は最大 8 日分です。
- 「チャンネルスキップ設定」(P.116) で、スキップ「する」に設定したチャンネルの番組表は表示されません。
- データ放送の視聴中は番組表に切り換わらないことがあります。その場合は、テレビ放送に切り換えてから操作してください。
- 番組の中止・変更・延長などによって、実際の放送内容が番組表と異なる場合があります。番組表や番組情報などで表示される内容および利用した結果について、当社は一切の責任を負いません。
- 「放送メディア」は、サブメニューの「テレビ/ラジオ/データ切換」(P.27) で「ラジオ」または「データ」を選んでいるときに表示されます。

視聴制限番組について

- 視聴制限番組について、詳しくは「視聴できる番組を制限する」(P.119) をご覧ください。
- 番組表で視聴制限を一時解除するときは、「番組表で視聴制限を一時解除する」(P.22) をご覧ください。

番組を見ながら他の番組を探す (ミニ番組表)

- 番組を見ながら、画面の下側にミニ番組表を表示させて番組を探すことができます。

1、番組表を表示中に番組表を押す

- ミニ番組表が表示されます。
- もう一度押すと、ミニ番組表が消えます。
- 操作方法は、(P.16) の番組表を使うと同じです。

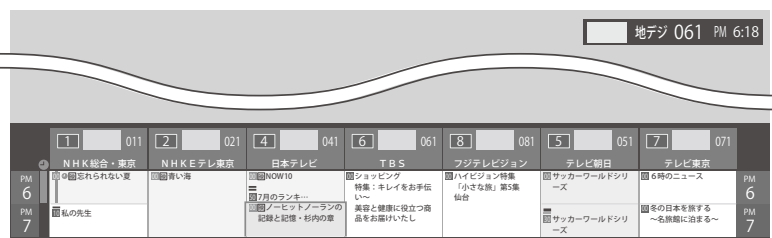

番組表で番組を探す (つづき)

番組表を便利に使う

- カラーボタンや番組表のサブメニューで、さまざまな便利機能を使うことができます。
- 番組表またはミニ番組表が表示されているときに以下の操作をします。
(ミニ番組表では一部の機能を使用できません)

指定した日時の番組表を表示させる

- 日付と時間帯を選んで番組表を表示させることができます。

1、青（日時切換）を押す

2、▲・▼・◀・▶で日時を選び、決定を押す

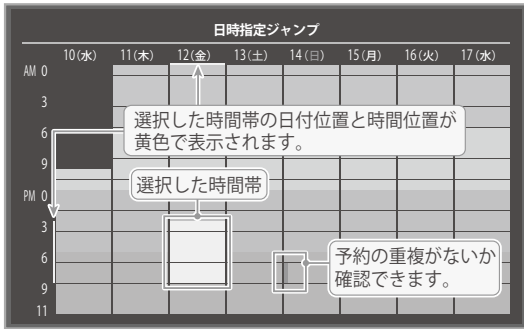

週間番組表を表示させる

- 選んだ放送局の一週間分の番組表を表示させることができます。

1、◀・▶で週間番組表を表示させたいチャンネルを選び、黄（週間番組表）を押す

一週間分の番組表を表示させたい放送局の番組を選びます。

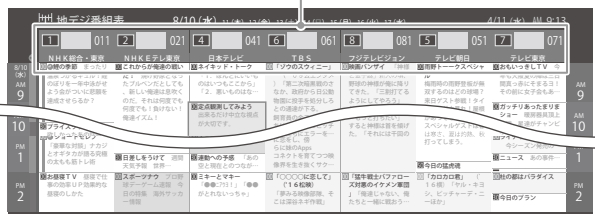

[通常番組表]



黄を押すたびに切り換わります

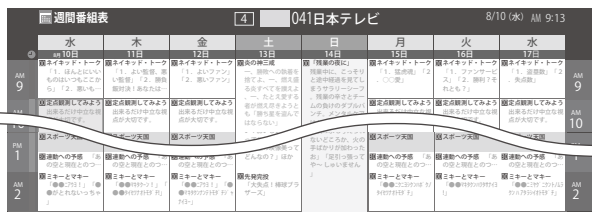

[週間番組表]

- 操作方法は、(P.16) の番組表を使うと同じです。
- 番組表の表示を週間番組表にしているときは、「マルチ表示」(P.19) に切り換えることはできません。

番組説明を見る

- 選択中の番組の番組説明を見ることができます。

1、番組説明 を押す

番組表を更新する

- 番組表の中が空になっているときや、最新の番組情報に更新するときは、以下の操作をします。

1、サブメニュー を押し、▲・▼で「番組情報の取得」を選んで 決定 を押す

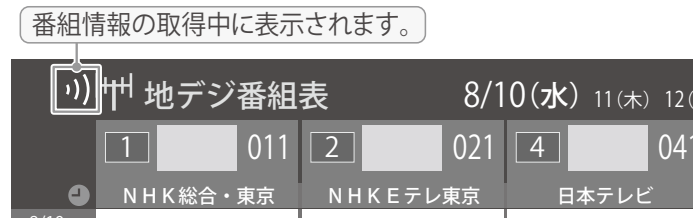

※ 番組情報の取得中は映像、音声が出ないことがあります。

※ BS・110度CSの4K放送録画中は、BS・110度CS 4K放送の番組情報の取得ができません。

◆ 番組表で選択している放送局の情報が更新されます。(更新の範囲は、放送の運用により、一部例外や将来変更されることがあります。)

- ・ BS デジタル放送は番組表全体が更新されます。
- ・ 110度CS デジタル放送は選択した番組が含まれるネットワークの番組表全体が更新されます。
- ・ 地上デジタル放送は選択した番組が含まれる放送局が更新されます。
- ・ BS・110度CSの4K放送は選択した番組が含まれるチャンネルが更新されます。

● 番組情報取得中にほかの操作をすると、情報の取得が中止されることがあります。

● 番組情報の取得を中止するときは、番組情報取得中にサブメニューを押し、サブメニューから「番組情報の取得中止」を選択します。

お知らせ・・

- 番組表の操作ガイドに表示される 緑 (番組検索) については、「条件を絞りこんで番組を探す」(P.23) をご覧ください。

1 チャンネル表示とマルチ表示を切り換える

● BS デジタル放送や地上デジタル放送 (どちらもテレビ放送だけ) では、放送事業者ごとの代表チャンネル表示 (1 チャンネル表示) とマルチチャンネル表示 (マルチ表示) の切り換えができます。

1、切り換える放送局の番組をどれか選び、サブメニュー を押す。

2、▲・▼で「1 チャンネル表示」(または「マルチ表示」) を選び、決定 を押す

- 番組表の表示によって、「マルチ表示」または「1 チャンネル表示」が表示されています。
- 「1 チャンネル表示」、「マルチ表示」を選ぶと、以下のように切り換わります。

番組表で番組を探す (つづき)

別の番組がある場合、
灰色の二重縦線を表示

This screenshot shows a grid of TV programs for August 10th. A grey double vertical line is drawn across the grid, indicating a conflict between programs on different channels. The programs listed include NHK総合, NHK教育, NHKBS1, NHKBS2, NHKBS3, NHKBS4, NHKBS5, NHKBS6, NHKBS7, NHKBS8, NHKBS9, NHKBS10, NHKBS11, NHKBS12, NHKBS13, NHKBS14, NHKBS15, NHKBS16, NHKBS17, NHKBS18, NHKBS19, NHKBS20, NHKBS21, NHKBS22, NHKBS23, NHKBS24, NHKBS25, NHKBS26, NHKBS27, NHKBS28, NHKBS29, NHKBS30, NHKBS31, NHKBS32, NHKBS33, NHKBS34, NHKBS35, NHKBS36, NHKBS37, NHKBS38, NHKBS39, NHKBS40, NHKBS41, NHKBS42, NHKBS43, NHKBS44, NHKBS45, NHKBS46, NHKBS47, NHKBS48, NHKBS49, NHKBS50, NHKBS51, NHKBS52, NHKBS53, NHKBS54, NHKBS55, NHKBS56, NHKBS57, NHKBS58, NHKBS59, NHKBS60, NHKBS61, NHKBS62, NHKBS63, NHKBS64, NHKBS65, NHKBS66, NHKBS67, NHKBS68, NHKBS69, NHKBS70, NHKBS71, NHKBS72, NHKBS73, NHKBS74, NHKBS75, NHKBS76, NHKBS77, NHKBS78, NHKBS79, NHKBS80, NHKBS81, NHKBS82, NHKBS83, NHKBS84, NHKBS85, NHKBS86, NHKBS87, NHKBS88, NHKBS89, NHKBS90, NHKBS91, NHKBS92, NHKBS93, NHKBS94, NHKBS95, NHKBS96, NHKBS97, NHKBS98, NHKBS99, NHKBS100.

[1チャンネル表示]

放送事業者ごとの
1チャンネル表示

放送事業者ごとの
マルチチャンネル表示

This screenshot shows the same program guide grid as above, but with a multi-channel display for one of the programs. The program is shown in a larger font and includes details about the multiple channels it is being broadcast on. The channels listed are NHK総合, NHK教育, NHKBS1, NHKBS2, NHKBS3, NHKBS4, NHKBS5, NHKBS6, NHKBS7, NHKBS8, NHKBS9, NHKBS10, NHKBS11, NHKBS12, NHKBS13, NHKBS14, NHKBS15, NHKBS16, NHKBS17, NHKBS18, NHKBS19, NHKBS20, NHKBS21, NHKBS22, NHKBS23, NHKBS24, NHKBS25, NHKBS26, NHKBS27, NHKBS28, NHKBS29, NHKBS30, NHKBS31, NHKBS32, NHKBS33, NHKBS34, NHKBS35, NHKBS36, NHKBS37, NHKBS38, NHKBS39, NHKBS40, NHKBS41, NHKBS42, NHKBS43, NHKBS44, NHKBS45, NHKBS46, NHKBS47, NHKBS48, NHKBS49, NHKBS50, NHKBS51, NHKBS52, NHKBS53, NHKBS54, NHKBS55, NHKBS56, NHKBS57, NHKBS58, NHKBS59, NHKBS60, NHKBS61, NHKBS62, NHKBS63, NHKBS64, NHKBS65, NHKBS66, NHKBS67, NHKBS68, NHKBS69, NHKBS70, NHKBS71, NHKBS72, NHKBS73, NHKBS74, NHKBS75, NHKBS76, NHKBS77, NHKBS78, NHKBS79, NHKBS80, NHKBS81, NHKBS82, NHKBS83, NHKBS84, NHKBS85, NHKBS86, NHKBS87, NHKBS88, NHKBS89, NHKBS90, NHKBS91, NHKBS92, NHKBS93, NHKBS94, NHKBS95, NHKBS96, NHKBS97, NHKBS98, NHKBS99, NHKBS100.

[マルチ表示]

●「マルチ表示」での番組予約については、(P.49)をご覧ください。

文字サイズを大きくする

● 番組表の文字が小さくて見えにくいときなどに、文字の大きさを切り換えることができます。

1、赤 を押し文字の大きさを切り換える

● ボタンを押すたびに、文字の大きさが変わります。文字の大きさに合わせて、表示する時間帯も変わります。

ジャンル別に色分けする

● 番組のジャンル(分野)別に色分けをすれば、見たい番組を探すのに便利です。

● お買い上げ時に設定されている色分けを、以下の操作で変更することができます。

1、サブメニュー を押し、▲・▼で「ジャンル色分け」を選んで決定 を押す

2、設定する色を▲・▼で選び、決定 を押す

The screenshot shows a menu titled 'ジャンル色分け' (Genre Color Setting). Below the title, it says '設定する色を選んでください。' (Please select the color to set). There are five options with corresponding color swatches: 'スポーツ' (Sports) in red, 'ドラマ' (Drama) in blue, '音楽' (Music) in green, '映画' (Movie) in yellow, and 'アニメ/特撮' (Anime/Special Effects) in purple. At the bottom, there is a '設定完了' (Setting Complete) button.

3、▲・▼・◀・▶でジャンルを選び、決定 を押す

- 決定 を押すと手順2の画面に戻ります。ほかの色の設定を変える場合は、操作を繰り返します。
- 「指定しない」を選ぶと、色分け表示がなくなります。

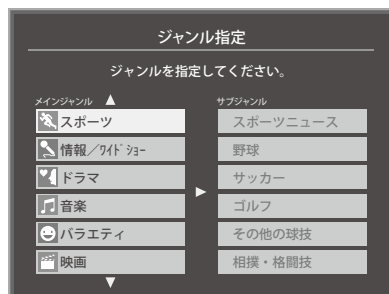

4、▲・▼で「設定完了」を選び、決定 を押す。

用語

■ (放送の) ネットワーク

デジタル放送の放送の単位。チャンネルや番組についての情報は、このネットワークごとに送られてきます。

番組記号の説明を見る

- 新、再、字などの番組記号の意味を調べることができます。

1、サブメニュー を押し、▲・▼で「番組記号一覧」を選んで 決定 を押す

- 番組記号の説明が表示されます。
- 表示されるのは番組記号の一部です。
- 見終わったら、決定 を押します。

表示させるチャンネル数を設定する

- 番組表に表示させるチャンネル数を切り換えることができます。

1、サブメニュー を押し、▲・▼と 決定 で「番組表表示設定」⇒「表示チャンネル数」の順に進む

2、▲・▼で表示させるチャンネル数を選び、決定 を押す

チャンネルの並び順を設定する

- 番組表に表示させるチャンネルの並び順を切り換えることができます。

1、サブメニュー を押し、▲・▼と 決定 で「番組表表示設定」⇒「チャンネル並び順」の順に進む

2、▲・▼で以下のどちらかを選び、決定 を押す

- ・ 通常
- ・ 放送局推奨の並び順になります。
- ・ チャンネルボタン優先
- ・ ワンタッチ選局ボタン1～12の番号順に並びます。

番組表で番組を探す (つづき)

番組概要の表示／非表示を設定する

● 番組の概要説明を表示させるかどうかを設定します。

- 1、サブメニュー を押し、▲・▼と 決定 で「番組表表示設定」⇒「番組概要表示」の順に進む
- 2、▲・▼で「表示する」、「表示しない」のどちらかを選び、決定 を押す

地上デジタル放送局の表示位置を設定する

● 地上デジタル放送の番組表で放送局の表示位置を設定します。

- 1、サブメニュー を押し、▲・▼と 決定 で「番組表表示設定」⇒「地デジ表示」の順に進む
- 2、▲・▼で以下のどちらかを選び、決定 を押す
 - ・視聴チャンネル中央表示・・・視聴中のチャンネルが番組表の中央に表示されます。
 - ・チャンネル順優先表示・・・お住まいの地域のチャンネル順に表示されます。

番組表の放送メディアを切り換える

- 番組表に表示させる放送メディア（テレビ、ラジオ、独立データ）を選びます。
- 放送が運用されていない放送メディアに切り換えることはできません。

- 1、サブメニュー を押し、▲・▼で「テレビ／ラジオ／データ切換」を選んで 決定 を押す
- 2、▲・▼で「テレビ」、「ラジオ」、「データ」から選んで 決定 を押す

番組表で視聴制限を一時解除する

番組表を表示中に視聴制限の一時解除ができます。

- 1、サブメニュー を押し、▲・▼で「視聴制限一時解除」を選んで 決定 を押す
 - 暗証番号入力画面が表示されます。
 - ※ すでに一時解除されている場合や、地上デジタル放送などの場合は、「視聴制限一時解除」は選べません。
- 2、1～10(0)で暗証番号を入力する
 - 番組表の視聴制限が一時解除されます。

用語・・

■ 放送メディア
デジタル放送の媒体（テレビ放送、データ放送、ラジオ放送）をさします。

条件を絞りこんで番組を探す

● 番組のジャンル（分野）やキーワードなどの条件を指定して、見たい番組を探すことができます。

1、番組表を押して、番組表を表示させる

2、緑（番組検索）を押す

● 番組検索画面が表示されます。

3、検索するグループのタブを◀・▶で選ぶ

● 以降の手順で指定する検索条件のうち、「日付」以外は検索グループごとに記憶されます。

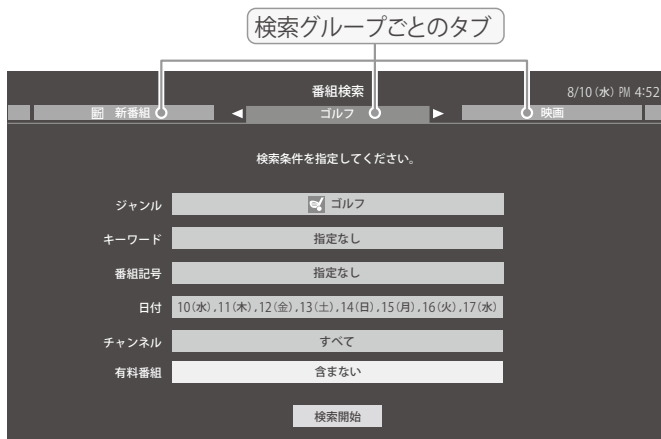

4、検索条件を指定する

● 「ジャンル」、「キーワード」、「番組記号」のどれかは必ず指定してください。

「ジャンル」を指定するとき

① ▲・▼で「ジャンル」を選び、決定を押す

② 指定するジャンルを▲・▼・◀・▶で一つ選び、決定を押す。

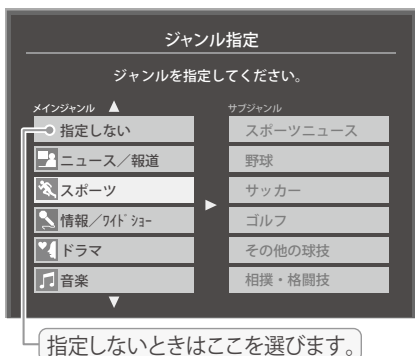

条件を絞りこんで番組を探す (つづき)

「キーワード」を指定するとき

- ① ▲・▼で「キーワード」を選び、決定を押す
 - ② 指定するキーワードを▲・▼・◀・▶で選び、決定を押す
- お買い上げ時は登録されていません。

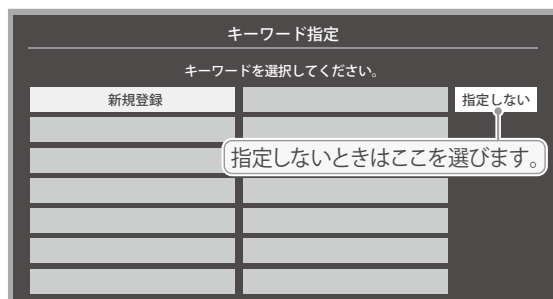

■ 新しいキーワードを登録する場合

- ① ▲・▼・◀・▶で「新規登録」を選び、決定を押す
- 文字入力画面が表示されます。
- ② キーワードを入力して、決定を押す
- 文字入力の方法は、(P.38)をご覧ください。
● キーワードは 14 個まで登録できます。

■ キーワードを編集する場合

- ① 編集するキーワードを▲・▼・◀・▶で選び、青を押す
- ② キーワードを編集し、決定を押す

■ キーワードを削除する場合

- ① 削除するキーワードを▲・▼・◀・▶で選び、赤を押す
- ② ▲・▼で「はい」を選び、決定を押す

「番組記号」を指定するとき

- ① ▲・▼で「番組記号」を選び、決定を押す
- ② 指定する番組記号を▲・▼・◀・▶で選び、決定を押す

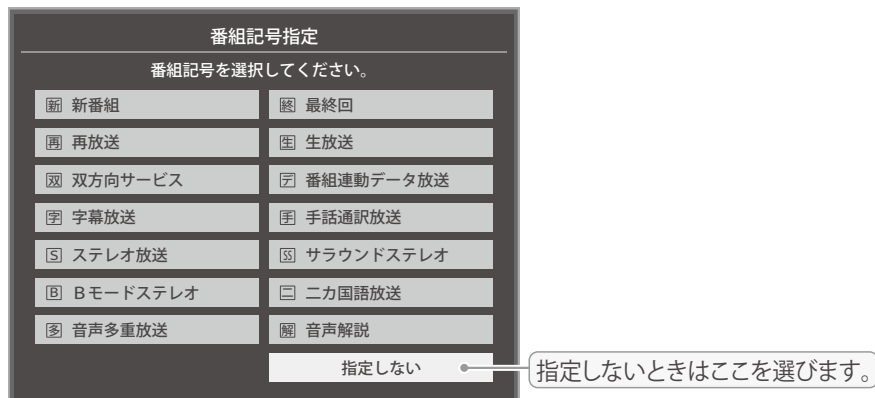

「日付」を指定するとき

- ① ▲・▼で「日付」を選び、決定を押す
- ② 指定する日付を▲・▼・◀・▶で選び、決定を押す
 - 決定を押すたびに、☑(指定する)と☐(指定しない)が交互に切り換わります。
 - 7日先まで指定できます。

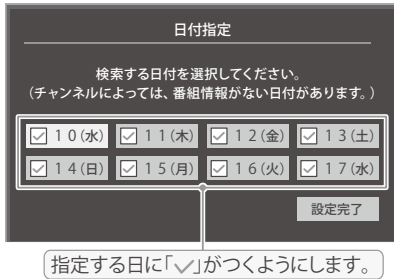

- ③ 指定が終わったら、▲・▼・◀・▶で「設定完了」を選び、決定を押す。

「チャンネル」を指定するとき

- ① ▲・▼で「チャンネル」を選び、決定を押す
- ② 指定する項目を◀・▶で選び、▲・▼で内容を選ぶ



- ・ 放送の種類・・・すべて / BS / CS / BS/CS 4K / 地デジ
 - ・ チャンネル・・・指定した放送の種類やメディアに該当するチャンネル / すべて
- ③ 指定が終わったら、決定を押す

「有料番組」を指定するとき

- 有料番組を検索対象に含めるかどうかを指定します。
- ① ▲・▼で「有料番組」を選び、決定を押す。
 - ② ▲・▼で「含む」、「含まない」のどちらかを選び、決定を押す。

5、▲・▼で「検索開始」を選び、決定を押す

- 選択中のタブの検索グループに、手順3で指定した検索条件が上書きで保存されます。

条件を絞りこんで番組を探す (つづき)

6、「番組検索結果」画面から、見たい番組を▲・▼で選んで決定を押す。



- 現在放送中の番組を選んだときは、「番組指定録画」画面が表示されます。
- これから放送される番組を選んだときは、「番組指定予約」画面が表示されます。(P.48)の手順3をご覧ください。
- すべての放送が表示されているときに、地デジを押すと地デジ放送だけ、BSを押すとBS放送だけ、CSを押すとCS放送だけ、4Kを押すとBS・110度CSの4K放送だけの検索結果になります。

7、▲・▼・◀・▶で「見る」を選び、決定を押す。

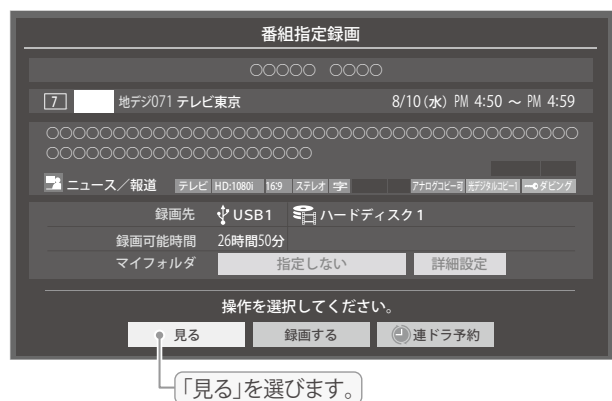

- 選んだ番組の放送画面になります。

お知らせ・・・・・・・・・・・・・・・・・・・・・・・・

- 番組の詳細情報はキーワード検索の対象になっていません。
- 「チャンネルスキップ設定」(P.116)で、スキップ「する」に設定したチャンネルの番組は番組検索の対象になりません。
- 番組検索の結果は指標としてお使いください。内容および利用した結果について、当社は責任を負いません。

データ放送やラジオ放送を楽しむ

データ放送について

- デジタル放送では映像や音声によるテレビ放送以外に、データ放送があります。
- データ放送には、テレビ放送チャンネルとは別の独立したチャンネルで行われているデータ放送のほかに、テレビ放送チャンネルで提供されている番組連動データ放送や、番組案内、ニュース、天気予報などのデータ放送があります。

データ放送やラジオ放送を楽しむ (つづき)

- インターネットや電話回線を利用して、視聴者と放送局との間で双方向に通信できるサービスです。クイズ番組に参加して回答したり、ショッピング番組で商品を購入したりすることができます。(本機は、電話回線を利用した双方向サービスには対応していません)
- 地上デジタル放送の双方向サービスには、放送番組に連動した通信サービスと、放送番組とは無関係な通信サービスがあります。



非リンク型サービス

放送番組とは無関係な通信サービスのときに表示されます。(文字表示は数秒で消えます)

ラジオ放送について

- ラジオ放送が運用された場合、本機で放送を聴くことができます。

連動データ放送を楽しむ

- 一部の番組には番組連動データ放送があります。双方向サービスが行われている番組連動データ放送では、番組に参加して楽しむことができます。
- テレビ放送チャンネルで、天気予報やニュース、番組案内などのデータ放送を提供している場合があります。

1、dデータを押す

- 番組によっては押す必要がない場合があります。
- 放送画面に表示される操作メニューや操作説明などに従って操作をします。

2、データ放送を終了するには、dデータを押すか、サブメニューを押し、▲・▼と決定で「その他の操作」⇒「データ放送終了」の順に進む

独立データ放送やラジオ放送を楽しむ

- BS デジタル放送などで運用される独立データ放送チャンネルやラジオ放送チャンネルを選ぶときの操作

1、放送の種類を選ぶ

- BS デジタルの独立データ放送やラジオ放送を視聴する場合は、BS を押します。

2、サブメニューを押し、▲・▼と決定で「その他の操作」⇒「テレビ/ラジオ/データ切替」の順に進む

3、▲・▼で「データ」または「ラジオ」を選び、決定を押す

- チャンネルで他のチャンネルに切り換えられます。
チャンネル番号を入力して選ぶこともできます。
- データ放送やラジオ放送を終了するには、上記の操作で「テレビ」を選びます。

お知らせ.....

- 放送データの取得中は一部の操作ができないことがあります。
- 放送画面の操作説明などで、dデータは「データボタン」、「データ放送ボタン」など表示されることがあります。
- データ放送は録画できません。

データ放送やラジオ放送を楽しむ (つづき)

■ 双方向サービスについて

- 双方向サービスを利用する場合は、あらかじめインターネットへの接続と設定 (P.95) ~ (P.101) をしてください。また、双方向サービスの利用には登録の申し込みなどが必要な場合があります。
- 双方向サービスでは、お客様の個人情報の入力を要求されることがありますが、接続先のサイトによっては SSL などによる通信時のセキュリティ対策が行われていない場合があります。
- 双方向サービスの利用時は、通信に時間がかかり、次の操作がすぐにできないことがあります。
- 本機の動作中に電源プラグを抜かないでください。本機が記憶している双方向サービスでのお客様のポイント情報などが更新されないことがあります。

便利な機能を使う

画面サイズについて

- 選択できる画面サイズは下表のとおりです。
- 画面の見えかたについては、(P.30) をご覧ください。
- 信号フォーマットについては、「本機で対応している HDMI 入力信号フォーマット」(P.126) をご覧ください。

放送番組やビデオ入力端子からの映像や動画の再生を見ているとき

映像の種類	選択できる画面サイズ
デジタル放送の 4:3 の映像 (480p、480i)、映像入力端子	フル、ノーマル、映画字幕、ズーム、スーパーライブ
デジタル放送の 16:9 の映像	フル、HD ズーム、HD スーパーライブ ・画面サイズを変更した番組の放送中は、選んだ画面サイズが保持されます。番組終了後、選局操作をすると「フル」に戻ります。 ・電源入/切で「フル」に戻ります。
3840X2160p の映像	4K フル、4K ズーム

HDMI 入力端子からの映像を見ているとき

映像や信号フォーマットの種類	選択できる画面サイズ
480i、480p	フル、ノーマル、ネイティブ、映画字幕、ズーム、スーパーライブ
VGA、SVGA、XGA、SXGA	フル、ノーマル、ネイティブ、ズーム、スーパーライブ
720p、1080i、1080p、WXGA	フル、ノーマル、ネイティブ、HD ズーム、HD スーパーライブ
WQHD	フル、Dot By Dot
3840X2160p	4K フル、4K ズーム
3840X2160p	4K フル、4K ノーマル、4K ズーム ・「4K ズーム」は入力切替、電源入/切などで「4K フル」に戻ります。

映像メニューを「ゲーム」、「PC」にしているとき

入力端子	信号フォーマットの種類	選択できる画面サイズ
映像入力端子	480i	フル、ノーマル
HDMI 入力端子	480p、480i、VGA、SVGA、XGA、WXGA、SXGA	フル、ノーマル、ネイティブ
	1080p、1080i、720p	フル、ネイティブ
	WQHD	フル、Dot By Dot
	3840X2160p	4K フル
	4096X2160p	4K フル、4K ノーマル





便利な機能を使う (つづき)

お知らせ.....

- 本機は、各種の画面サイズのモード切換機能を備えています。テレビ番組等のソフトの映像比率と異なるモードを選択すると、本来の映像とは見えかたが異なります。
- 視聴する映像のフォーマットと画面サイズの組合せによっては、周囲の映像が隠れたり、画面の周囲が黒で表示されたり、左右の端がちらついたりすることがあります。また、放送画面に表示される選択項目を選ぶ際に枠がずれて表示されることがあります。
- 4:3の映像を「スーパーライブ」などを利用して画面いっぱいに表示させると、周辺画像が一部見えなくなったり、変形して見えたりします。制作者の意図を尊重した本来の映像は、「ネイティブ」、「ノーマル」(16:9映像の場合は「フル」)でご覧になれます。
- テレビを公衆に視聴させることを目的として、喫茶店、ホテル等に置いて、画面サイズの切換機能を利用して画面の圧縮や引き伸ばしなどすると、著作権法上で保護されている権利を侵害するおそれがありますので、ご注意ください。

画面の見えかたについて

入力	画面サイズのモード	画面の見えかた	説明
4:3	スーパーライブ	※1 	4:3の映像をワイド画面で楽しむモードです。画面を上下左右に引き伸ばします。上下方向よりも左右方向をより引き伸ばします。
	ズーム	※1 	上下が黒い帯になっている映画などのワイド映像(レターボックス「LB」)を拡大して楽しむモードです。
	映画字幕	※1 	レターボックスのワイド映像の下に字幕がはいつている場合に、字幕を隠れにくくするモードです。
	フル	※1 	DVDソフトなどのスクイーズ映像(縦に伸びて見える映像)を、ワイド映像で表示するモードです。
	ノーマル		4:3の映像をそのままの横と縦の比で表示するモードです。
16:9	フル		16:9の映像を画面いっぱいに表示するモードです。
	HDスーパーライブ ※2	※3 	左右に帯(黒や模様など)のある16:9の映像をワイド画面で楽しむモードです。画面を上下左右に引き伸ばします。上下方向よりも左右方向をより引き伸ばします。
	HDズーム ※2	※3 	上下左右に帯(帯も映像として送られています)のある16:9の映像をワイド画面で楽しむモードです。
ゲーム	フル	※4 	ゲーム映像をテレビ画面いっぱいに拡大して表示するモードです。
	ノーマル		ゲーム映像をそのままの横と縦の比で表示するモードです。(図は4:3の例です)
	ネイティブ		入力信号の1ドットを縦・横2ドットずつの4ドットで表示するモードです。映像の無い部分は黒く表示されます。
HDMI	ネイティブ		入力信号の1ドットを縦・横2ドットずつの4ドットで表示するモードです。映像の無い部分は黒く表示されます。
	Dot by Dot (WQHD)		入力信号の解像のまま画面に表示するモードです。映像のない部分は黒く表示されます。

入力	画面サイズのモード	画面の見えかた	説明
4K 信号	4Kフル (3840X2160p)		4K信号の映像をそのままの横と縦の比で表示します。
	4Kフル (4096X2160p)		4K信号の映像をそのままの横と縦の比で表示するモードです。 (左右が128画素ずつ切れた状態で表示されます)
	4Kフル (4096X2160p)		4K信号の映像を画面に合わせて縮小して表示するモードです。 (上下の映像がない部分は黒く表示されます)
	4Kズーム (3840X2160p)	※5 	上下左右に帯(帯も映像として送られています)のある映像を、 ワイド画面で楽しむモードです。
	4Kズーム (4096X2160p)	※5 	上下左右に帯(帯も映像として送られています)のある映像を、 ワイド画面で楽しむモードです。

※1 左側の図は画面サイズのモードを「ノーマル」にした場合の見えかたです。

※2 デジタル放送のハイビジョン放送と標準画質放送の16:9の映像で切り換えることができます。

※3 左側の図は画面サイズのモードを「フル」にした場合の見えかたです。

※4 左側の図は画面サイズのモードを「ノーマル」にした場合の見えかたです。

※5 左側の図は画面サイズのモードを「4Kフル」にした場合の見えかたです。

画面サイズを切り換える

● 視聴している映像の種類に応じて、画面サイズを切り換えることができます。

- 1、サブメニュー を押し、▲・▼で「画面サイズ切換」を選び、決定 を押す
- 2、お好みの画面サイズを▲・▼で選び、決定 を押す
 - 画面の見えかたについては (P.30) をご覧ください。

▶が表示されるとき

● 決定 を押す前に、必要に応じて以下の操作をします。

- ① ▶を押し、お好みのモードを▲・▼で選ぶ

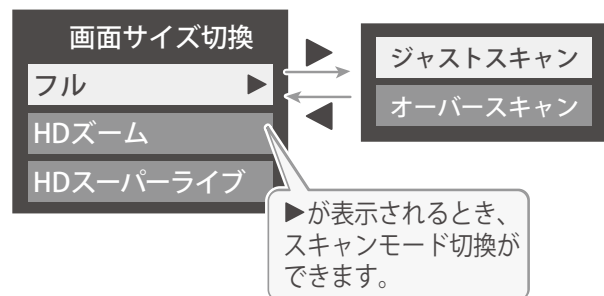

- ・ジャストスキャン・・・16:9の映像が画面内におさまるように表示させます。
- ・オーバースキャン・・・16:9の映像を少し大きめに表示させます。

便利な機能を使う (つづき)

降雨対応放送について

- BS デジタル放送や 110 度 CS デジタル放送および BS・110 度 CS の 4K 放送を視聴中に、雨や雪などで衛星からの電波が弱まった場合、放送局が運用していれば、降雨対応放送に切り換えて見ることができます。
- ※ 図のメッセージが表示された場合は、以下の手順で降雨対応放送に切り換えられます。
- ※ 降雨対応放送は、通常の放送よりも画質が低下します。

電波の受信状態が良くありません。
サブメニューから降雨対応放送に切り換えられます。

コード：E201

- 1、サブメニュー を押し、▲・▼と 決定で「その他の操作」⇒「信号切換」⇒「降雨対応放送切換」の順に進む
- 2、▲・▼で「降雨対応放送」を選ぶ
 - 降雨対応放送をやめるには、「通常の放送」を選びます。
 - 電波が強くなると、自動的に通常の放送に戻ります。

他の映像・音声を切り換える

音声多重番組で聴きたい音声を選ぶ

- 音声多重放送番組の場合、主音声、副音声、主：副を切り換えることができます。
- 番組説明画面に [二重音声] のアイコンが表示されます。

- 1、音声切換 を押す
 - 音声切換 を押すたびに以下のように切り換わります。

 - サブメニューの「音多切換」でも音声の切り換えができます。

音声を切り換える

- 複数の音声で放送されている番組の場合、音声 1、音声 2 などの音声信号を切り換えることができます。
- 番組説明画面に [信号切換] のアイコンが表示されます。

- 1、音声切換 を押す
 - 音声切換 を押すたびに以下のように切り換わります。

 - サブメニューの「音声信号切換」(次の説明)でも音声の切り換えができます。

映像、音声を切り換える

- デジタル放送では、一つの番組に複数の映像や音声がある場合があり、お好みで選択することができます。
- 映像、音声切り換えられる番組は、番組説明画面に [信号切換] のアイコンが表示されます。

- 1、サブメニュー を押し、▲・▼と 決定で「その他の操作」⇒「信号切換」の順に進む

2、切り換える信号を▲・▼で選び、決定を押す

- 視聴中の番組で切り換えのできない信号は、薄くなって表示されます。



3、視聴したい映像、音声を▲・▼で選び、決定を押す

- 「信号切換」のサブメニューに表示される「音声信号切換」、「音多切換」は、音声切換で選択する機能 (P.32) と同じです。

お知らせ.....

■ 信号切換について

- 選局操作をすると、信号切換で選択した状態は取り消されます。(基本の信号を選択した状態になります)
ただし音多切換と字幕切換では、選局しても状態は取り消されません。

映像を静止させる

- 映像の動きを止めることができます。料理番組のレシピや、視聴者プレゼントの応募先などをメモするときに便利です。

1、(静止) を押す

- 解除するときは、もう一度 (静止) を押します。
- 映像の静止中でも音声は流れ続けます。

お知らせ.....

- ラジオ、データ放送視聴中は静止画にできません。また、映像の静止中にデータ放送の操作はできません。
- 字幕放送の場合、映像の静止中に字幕は表示されません。
- 選局操作をすると静止画が解除されます。
- テレビを公衆に視聴させることを目的として喫茶店、ホテルなどで「静止画」を使用すると、著作権法で保護されている権利を侵害するおそれがありますので、ご注意ください。
- 映像を静止中に、入力されている信号が切り換わると、静止が解除されることがあります。

便利な機能を使う (つづき)

接続機器の情報を表示させる

● 外部入力視聴中（画面表示）を押したときに、画面左下に接続機器の情報が表示されるように設定することができます。

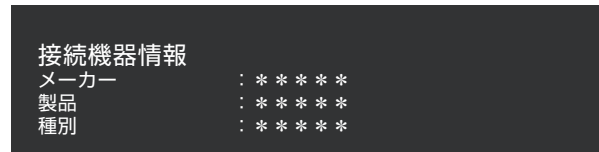

● お買い上げ時は表示されないように設定されています。表示させたい場合は、「オン」に設定してください。

- 1、設定 を押し、▲・▼と決定で「その他の設定」⇒「詳細機能設定」⇒「接続機器情報表示設定」の順に進む。
- 2、▲・▼で「オン」または「オフ」を選び、決定 を押す。
 - ・オン・・・（画面表示）を押したときに接続機器の情報が表示されます。
 - ・オフ・・・接続機器の情報は表示されません。

省エネ設定をする

● 省エネに関するさまざまな設定をすることができます。

- 1、設定 を押し、▲・▼と決定で「その他の設定」⇒「詳細機能設定」⇒「省エネ設定」の順に進む

● 「省エネ設定」の画面が表示されます。

- 2、設定する項目を▲・▼で選び、決定 を押す

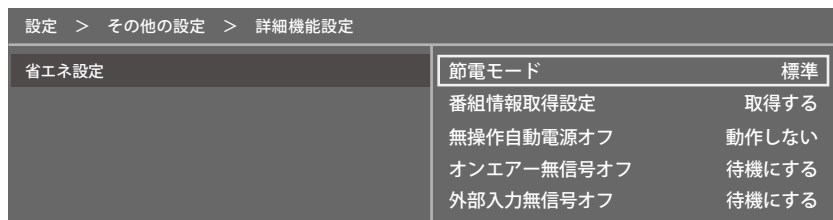

- 3、お好みの設定を▲・▼で選び、決定 を押す
 - 以降の説明を参照し、設定してください。

節電モード

● 液晶画面のバックライトの明るさをおさえることで本機の節電ができます。

● 「減 1」、「減 2」に切り換えた場合、画面の明るさをおさえて、その明るさに適した画質に自動調整されます。

- ・標準・・・標準の明るさです。
- ・減 1・・・画面の明るさを「標準」よりもおさえて、節電します。
- ・減 2・・・画面の明るさを「減 1」よりもおさえて、さらに節電します。

番組情報取得設定

● 番組表機能や予約機能を正しく働かせるために、「取得する」でを使用することをおすすめします。

- ・取得する・・・電源が「待機」や「切」のときに、デジタル放送の番組情報を取得します。取得時に電力を消費します。
- ・取得しない・・・番組情報を取得しません。そのため、番組表の内容が表示されなかったり、予約できなかったり、番組検索ができなかったりすることがあります。

無操作自動電源オフ

- ・待機にする・・・本機の無操作状態が約3時間続くと、電源が「待機」になります。
- ・動作しない・・・本機の無操作状態が続いても電源は「入」のままです。

オンエア無信号オフ

- ・待機にする・・・放送受信時に、無信号状態が約15分間続くと、電源が「待機」になります。
- ・動作しない・・・無信号状態が続いても電源は「入」のままです。

※ 外部入力を選んでいるときは機能しません。

外部入力無信号オフ

- ・待機にする・・・外部入力選択時に、無信号状態が約15分間続くと、電源が「待機」になります。
- ・動作しない・・・無信号状態が続いても電源は「入」のままです。

ヘッドホンで聴く

- ヘッドホンで聴くときの音の出かたを設定します。
- ヘッドホン出力設定には「通常モード」と「親切モード」があります。お買い上げ時は「通常モード」に設定されています。

※ ヘッドホン出力設定の設定のしかたについては、「ヘッドホン／音声出力設定」(P.111)をご覧ください。

1、設定 を押し、▲・▼と 決定 で「音声設定」⇒「音声出力詳細設定」⇒「ヘッドホン／音声出力設定」⇒「ヘッドホン出力設定」の順に進む

- ・通常モード・・・ヘッドホンだけで音声を聞くモードです。ヘッドホンのプラグを差し込むと、スピーカーから音声がなくなります。
- ・親切モード・・・ヘッドホンとスピーカーの両方で音声を聞くモードです。家族で視聴する場合など、スピーカーの音声が聞き取りにくい人がヘッドホンまたはイヤホンで聴くというような使いかたができます。

- 親切モードのとき、スピーカーの音量は +音量- で調節します。

ヘッドホンの音量調節のしかた

- 「通常モード」に設定しているときは、+音量- で調節します。
- 「親切モード」に設定して、ヘッドホンを接続しているときは、以下の手順で調節します。

① サブメニュー を押し、▲・▼と 決定 で「その他の設定」⇒「親切ヘッドホン音量」の順に進む

- ヘッドホンを接続していないときは、選択できません。

② ◀・▶で音量を調節する

- +音量- でも調節できます。

ご注意・・

- ヘッドホンで聴くときは、必ず「ヘッドホン／音声出力設定」の「出力設定」を「ヘッドホン」(P.111) にしてください。

便利な機能を使う (つづき)

外部スピーカーで聴く

● ヘッドホン／音声出力端子に音声出力機器を接続して聴くときの音の出かたを設定します。

1、サブメニューを押し、▲・▼で「スピーカー切替」を選び、決定を押し

2、▲・▼で「外部スピーカー」を選び、決定を押し

● 本機のスピーカーからは音は出ません。

● 「外部スピーカー出力設定」(P.111) が「固定」の場合は、接続した外部音声出力機器で音量を調節します。「可変」の場合は、本機のリモコンで音量を調節できます。

※ 「外部スピーカー出力設定」の設定のしかたについては、「ヘッドホン／音声出力設定」(P.111) をご覧ください。

時計を表示する

● 画面に時計を表示させます。

1、サブメニューを押し、▲・▼と決定で「時計」⇒「時計表示」の順に進む

2、▲・▼を押し、「大きいサイズ」、「小さいサイズ」または「オフ」を選び、決定を押し

● 「オフ」を選ぶと時計表示を消します。

自動で電源が入るようにする

● 設定した時刻に本機の電源が「入」になります。

● 目覚まし時計として使うこともできます。

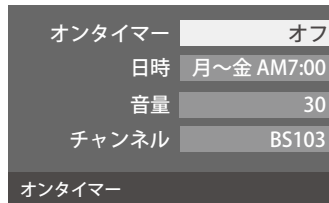

1、サブメニューを押し、▲・▼と決定で「時計」⇒「オンタイマー」の順に進む

2、以下の手順で設定する

オンタイマー

● オンタイマーを使用する、使用しないを設定します。

① ▲・▼で「オンタイマー」を選び、決定を押し

② ▲・▼で「オン」を選び、決定を押し

● オンタイマーを設定したあとにオンタイマーを解除する場合は、上記の操作で「オフ」を選びます。

日時

● オンタイマーで本機の電源を「入」にする日時を設定します。

① ▲・▼で「日時」を選び、決定を押し

② 設定する項目を◀・▶で選び、▲・▼で日時を選ぶ

● 曜日は「1回」、「毎日」、「毎週(日)」～「毎週(土)」、「月～木」、「月～金」、「月～土」の中から選びます。

③ 設定が終わったら、決定を押し

音量

● オンタイマーで電源が「入」になったときの音量を設定できます。

① ▲・▼で「音量」を選び、決定を押す

② ▲・▼でお好みの音量を選び、決定を押す

● 黄を押すと、選んだ音量を聴くことができます。もう一度押すと、元の音量に戻ります。

③ 設定が終わったら、決定を押す

※ サラウンドシステムスピーカーから音声が出力されている場合は、設定は出力に反映されません。
この場合、黄を押しても、選んだ音量を聴くことができません。

チャンネル

● オンタイマーで電源が「入」になったときに、画面に映すチャンネルを設定します。

① ▲・▼で「チャンネル」を選び、決定を押す

② 設定する項目を▲・▼で選び、▲・▼で内容を選ぶ

・ 放送の種類・・・ラストチャンネル / 地デジ / BS / CS / BS/CS 4K

・ チャンネル・・・設定した放送の種類に該当するチャンネル

※ ラストチャンネルは、電源を切る前に見ていたチャンネルになります。(番組予約により選局できない場合は、番組予約したチャンネルになります)

③ 設定が終わったら、決定を押す

自動で電源が切れるようにする

● オフタイマーを設定すると、設定時間後に電源が切れて、「待機」の状態になります。

オフタイマー
使用しない
あと30分
あと60分
あと90分
あと120分

1、サブメニューを押し、▲・▼と決定で「時計」⇒「オフタイマー設定」の順に進む

2、電源が切れるまでの時間を▲・▼で選び、決定を押す

● 電源が切れる1分前になると、画面にメッセージが表示されます。

● オフタイマーが設定されているときにサブメニューを押し「時計」を選択して決定を押すと、「オフタイマー」の項目に電源が切れるまでの残り時間が表示されます。

● オフタイマーを設定したあとにオフタイマーを解除する場合は、上記の操作で「使用しない」を選びます。

お知らせ.....

■「オンタイマー」について

● 本体の電源ボタンで電源を切ると「オンタイマー」が働きません。リモコンの電源ボタンで電源を切ってください。

● オンタイマーで電源がはいつてから約1時間操作をしなかった場合には、電源が自動的に「待機」になります。

● オンタイマーと番組予約が重なっていた場合には、ラストチャンネルで電源がはいることがあります。音量は、オンタイマーで設定した大きさに戻ります。

● オンタイマーを「1回」に設定し、指定した時刻に電源がはいつていた場合、オンタイマーは次の日に延期されます。

■「オフタイマー」について

● 設定後に電源を切ったり「待機」にしたりすると、設定が取り消されます。

文字を入力する

文字を入力する

- 番組検索のキーワード指定で、新しいキーワードを登録する場面などで文字入力画面が表示されます。

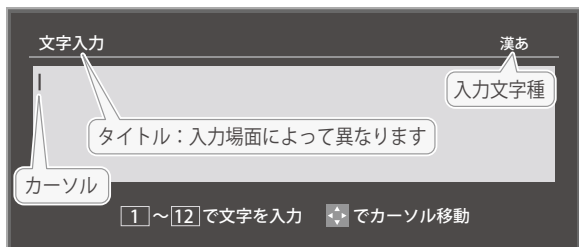

1、1 ~ 12 で文字を入力する

- 携帯電話と同様の操作で文字を入力します。

入力例：がっこう

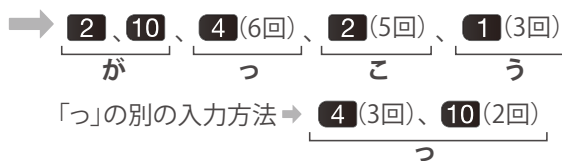

- 文字に続けて 10 を押せば、濁点 (`) や半濁点 (`) の入力および小文字変換ができます。
- 同じボタンに割り当てられた文字を続けて入力する場合は、次の文字の前に ▶ を押します。



- 入力文字の種類を変えるときは、青 (文字切換) を押します。
- 文字を挿入するには、挿入する場所を ▲・▼・◀・▶ で選んで入力します。
 <<・>> を押すと、カーソルがその行の先頭または末尾に移動します。
- スペースを入力するときは、緑 を押します。

文字を削除するには

- 1文字を削除するには、赤 を短く押します。
 カーソルの右に文字がない場合は、カーソルの左の1文字が削除されます。カーソルの右に文字がある場合はカーソルの右の1文字が削除されます。
- 文字をまとめて削除するには、赤 を押し続けます。
 カーソルの右に文字列がない場合は、文字がすべて削除されます。カーソルの右に文字列がある場合は、カーソルより右の文字がすべて削除されます。

2、以下の操作で文字を確定する

- 漢字に変換しないときは、決定 を押す
- 漢字に変換するときには、▼を繰り返し押し、希望の漢字が見つかったら 決定 を押す
 ・希望する漢字に変換されない場合は、変換する範囲を ◀・▶ で変え、▲・▼で再度変換します。

3、すべての入力が終わったら、決定 を押す

- 文字入力画面が表示される前の操作画面に戻ります。

文字切換（入力文字種の切り換え）

「漢あ」	漢字変換	ひらがなや漢字を入力できます。
「カナ」	全角カナ	カタカナを入力できます。
「a A」	全角英字	全角の英字を入力できます。
「abAB」	半角英字	半角の英字を入力できます。
「1 2」	全角数字	全角の数字を入力できます。
「1234」	半角数字	半角の数字を入力できます。
「全角記号」	全角記号	全角の記号を入力できます。
「半角記号」	半角記号	半角の記号を入力できます。

- 文字入力の場面によっては、使用できる入力文字種が少なかったり、切り換えられなかったりすることがあります。
- 入力文字種が「全角記号」、「半角記号」のときには、入力したい記号を文字入力画面から選びます。

入力文字一覧

リモコン	入力文字種			
	漢字変換	全角カナ	英字	数字
1	あ→い→う→え→お →あ→い→う→え→お	ア→イ→ウ→エ→オ →ア→イ→ウ→エ→オ	1→2→3→4→5→ 6→7→8→9→0	1
2	か→き→く→け→こ	カ→キ→ク→ケ→コ →カ→ケ	a→b→c →A→B→C	2
3	さ→し→す→せ→そ	サ→シ→ス→セ→ソ	d→e→f →D→E→F	3
4	た→ち→つ→て→と →つ	タ→チ→ツ→テ→ト →ツ	g→h→i →G→H→I	4
5	な→に→ぬ→ね→の	ナ→ニ→ヌ→ネ→ノ	j→k→l →J→K→L	5
6	は→ひ→ふ→へ→ほ	ハ→ヒ→フ→ヘ→ホ	m→n→o →M→N→O	6
7	ま→み→む→め→も	マ→ミ→ム→メ→モ	p→q→r→s →P→Q→R→S	7
8	や→ゆ→よ →や→ゆ→よ	ヤ→ユ→ヨ →ヤ→ユ→ヨ	t→u→v →T→U→V	8
9	ら→り→る→れ→ろ	ラ→リ→ル→レ→ロ	w→x→y→z →W→X→Y→Z	9
10	°→°→小文字変換	°→°→小文字変換	小文字変換	0
11	わ→を→ん→わ→、→。 →ー	ワ→ヲ→ン→ワ→、→。 →ー	※1	*
12	※2 逆方向へ入力	※2 逆方向へ入力	※2 逆方向へ入力	#

文字を入力する (つづき)

●最後の候補まで行くと、次は最初の候補に戻ります。

※1 全角英字の場合・・・・・・。→ / → : → - → _ → ~ → @

半角英字の場合・・・・・・. → / → : → - → _ → → @

※2 文字入力変換中に文字を通り過ぎたときに、逆方向へ戻します。

お知らせ・・

●入力した文字は、次のように表示されます。

入力中の文字：黄色背景／未確定の文字：白色背景／漢字変換候補選択中の文字：黒色背景／確定した文字：背景なし

●確定せずに変換できるのは4文節までです。4文節以上のときは、確定してから残りを変換してください。

●漢字候補選択時に戻るを押せば、その文節を未変換状態に戻すことができます。

録画機器の準備をする

録画・予約機能について

録画できる機器と番組

- 本体側面下段の USB（通常録画）端子に接続した USB ハードディスクにデジタルテレビ放送番組を録画できます。（データ放送、ラジオ放送番組、外部入力（HDMI1～4、ビデオ入力）で視聴している動画の映像・音声は録画できません）
 - ・ USB ハードディスクの接続は（P.42）をご覧ください。

接続・設定と録画前の準備

録画する機器	録画前の準備
USBハードディスク ^(注)	<ul style="list-style-type: none"> ・ USBハードディスクの電源を入れておきます。 ・ USBハードディスクの残量を確認します。（P63） ・ 「すべて」のタブの録画リストで「録画番組数」を確認します。（P57） ※ 残量不足や番組数超過(3000を超過)になりそうな場合は、不要な番組を削除します。（P64）

(注) USB ハードディスクは、本機に登録しないと録画できません。

- 録画や録画予約の操作をしたときに接続した機器が選択できないときは、（P.43）を参照し、登録してください。
- USB ハードディスクは専用の AC アダプターを接続してご使用ください。AC アダプターを使用しない場合は動作保証できません。
 - ※ USB ハードディスクの最大予約件数は 128 です。最大録画番組数は 3000 です。

USB ハードディスクの自動削除機能について

- USB ハードディスクの容量が足りない場合に、保護されていない日付の古い録画済番組から自動的に削除する機能で、お買い上げ時は「自動削除設定」（P.65）が「削除しない」に設定されています。

ご注意

● USB ハードディスクについて

USB ハードディスクは精密機器であり、使用環境などによっては数年で故障する可能性があります。

本機に接続した USB ハードディスクに録画した内容の長期保存は保証できません。一時的な保存・再生機能としてご使用ください。

お知らせ

- USB ハードディスクでの録画中に停電したり、電源プラグを抜いたりすると、途中まで録画した番組は正しく保存されません。（「録画番組を修復する」（P.60）の操作をすれば、録画された内容を再生できるようになります）
- 予約録画の開始時に、自動削除機能によって削除される番組が多い場合は、番組の冒頭部分が録画されないことがあります。
- 録画番組の再生中に予約録画の開始時刻になると、再生が自動的に停止することがあります。
- 万一、本機の故障や受信障害などによって正常に録画・録音できなかった場合の補償は一切できませんので、あらかじめご了承ください。

USBハードディスクの接続をする

USBハードディスクの接続をする

- 本機に接続したUSBハードディスクで以下のことができます。

できること	記載ページ
本機で受信したテレビ放送番組の録画、録画予約	(P.47)
録画番組の再生、ムーブ	(P.57) (P.68)

ご注意

- パソコンや他のテレビ、録画機器などで使用していたUSBハードディスクを本機に接続して登録すると、それまでに保存されていたデータや録画番組などはすべて消去されます。
- 本機で使用していたUSBハードディスクをパソコンで使用するには、パソコンで初期化する必要があります。その際に、本機で録画した番組はすべて消去されます。
- 本機に接続したUSBハードディスクを取りはずす場合は、未登録の機器を含めて「USBハードディスクの設定をする」の「機器の取りはずし」(P.45)の手順で操作してください。
- USBハードディスクの動作中は、USBハードディスクの電源を切ったり、接続ケーブルを抜いたりしないでください。録画した番組が消えたり、USBハードディスクが故障したりする原因となります。
- 本体側面上段のUSB端子にUSBバスパワー方式の機器を接続して同時に使用すると、USBハードディスクでの録画動作に障害を与えることがあります。
- USBハードディスクやUSBハブは専用のACアダプターを接続してご使用ください。ACアダプターを接続しない場合は動作保証できません。

USBハードディスクが1台のとき

- USBハードディスクは、USB（通常録画）端子に接続します。
- ※上段USB端子はメディアプレイヤー専用のため使用できません。

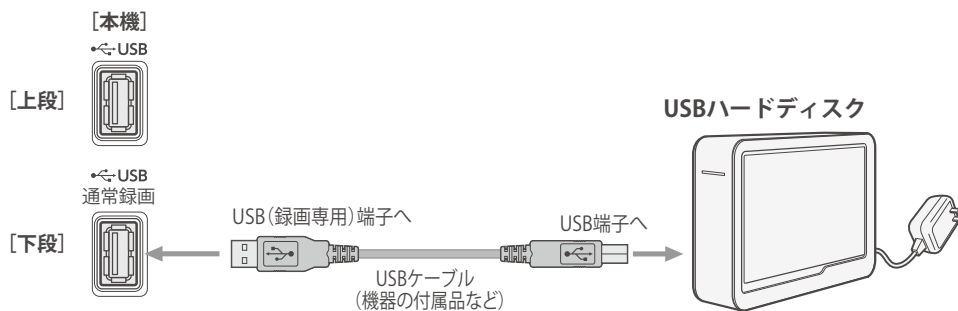

USBハードディスクが複数のとき

- USBハブを使用すれば、複数のUSBハードディスクを接続することができます。
- ※上段USB端子はメディアプレイヤー専用のため使用できません。
- ※8台までのUSBハードディスクを本機に登録できます。ただし、同時に接続できるのは4台までです。

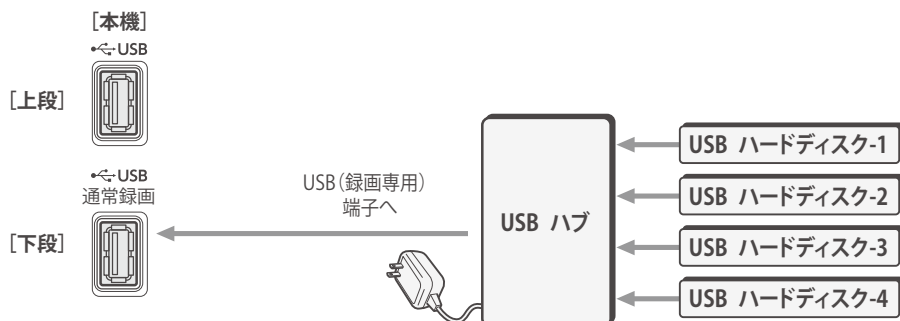

お願い.....

- 複数の未登録 USB ハードディスクを接続した状態で本機の電源を入れると、不特定の順番で登録が始まります。
USB ハードディスクの登録名や接続場所などを特定しやすくするために、1 台ずつ接続して登録の処理が終わったら次の USB ハードディスクを接続するようにしてください。
- 登録の手順については、次の「USB ハードディスクを本機に登録する」をご覧ください。

お知らせ.....

- 複数台の USB ハブを経由して本機に USB ハードディスクを接続することはできません。

USB ハードディスクの設定をする

USB ハードディスクを本機に登録する

- 本機が未登録の USB ハードディスクを検出すると、「機器の登録」の画面が表示されます。
以下の手順で本機に登録します。

1、◀・▶で「はい」を選んで決定を押す

- 登録しないときは「いいえ」を選びます。

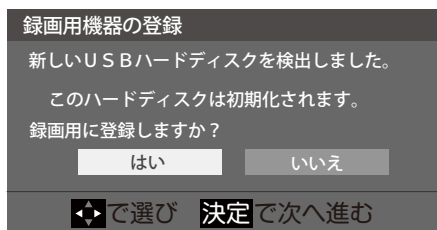

※「いいえ」を選んだ場合、その USB ハードディスクは「機器の登録」の画面で「未登録」となります。「未登録」の USB ハードディスクを登録する場合は、次の「USB ハードディスクの設定をする」で「機器の登録」の操作をしてください。

2、初期化の確認画面で、◀・▶で「はい」を選んで決定を押す

- 登録の処理が始まり、終わると次の手順の画面が表示されます。

3、登録名を変更する場合は、◀・▶で「はい」を選んで決定を押す

- 表示された登録名のままでよければ「いいえ」を選びます。
- 「はい」を選んだ場合は、文字入力画面が表示されます。登録名を入力して、決定を押します。
- 文字入力の方法は、(P.38) をご覧ください。
- ◻ (スペース) だけの名称は登録できません。

4、登録した USB ハードディスクを録画機器にする場合は、◀・▶で「はい」を選んで決定を押す

- 録画や予約などでの録画機器の初期候補が、今登録した USB ハードディスクになります。
※ 録画機器は、録画や予約の際に変更することもできます。
- 決定を押したあと、説明画面が表示された場合は、画面の説明を読んでから決定を押します。

5、登録結果の内容を確認し、終了を押す

USBハードディスクの接続をする (つづき)

使用履歴のある USB ハードディスクを接続したとき

- 本機に登録して使用し、登録を解除した USB ハードディスクを接続した場合、以下の確認画面が表示されます。

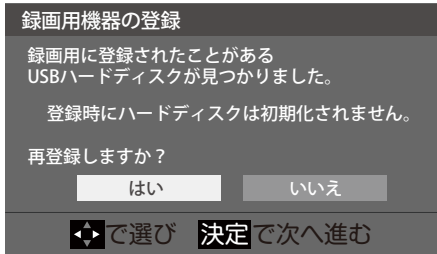

- 「はい」を選んで決定を押すと登録の処理が始まり、終わると登録機器のリスト画面が表示されます。

※ 再登録の場合、ハードディスクは初期化されません。

修理などで、本機内部のハードディスク登録情報記憶部が含まれる部分を交換した場合や、本機を交換した場合は、それまでに使用していたハードディスクは未登録（新しいハードディスク）として認識され、初期化して使用することになります。初期化の際に録画内容はすべて消去されます。

USBハードディスクの設定をする

設定	
映像設定	録画・再生設定
音声設定	USBハードディスク設定
録画・再生設定	録画設定
通信設定	再生設定
放送受信設定	オートメディアプレーヤー
初期設定	通信設定
その他設定	詳細設定
	接続テスト
	ネットワーク情報

- USBハードディスクを使用する場合は、必要に応じて以下の設定をします。
 - 1、設定を押し、▲・▼と決定で「録画・再生設定」⇒「USBハードディスク設定」の順に進む
 - 2、設定する項目を▲・▼で選んで決定を押し、以降の手順で設定する

機器の登録

- リストに「未登録」と表示されている USB ハードディスクを登録したり、機器の登録名を変更したり、登録を解除したりすることができます。

※ 登録できるのは8台までです。

※ USBハードディスクによっては、機器の登録画面でモデル名が正しく表示されないことがあります。

機器を登録するとき

※ はじめて登録するときには、USBハードディスクに保存されている内容はすべて消去されます。

- ① 登録する機器を▲・▼で選び、決定を押す
- ② 登録の確認画面で、◀・▶で「はい」を選んで決定を押す
- ③ 初期化の確認画面で、◀・▶で「はい」を選んで決定を押す
 - ・初期化と登録の処理が始まります。
- ④ 終わったら、登録結果の内容を確認し、決定を押す

登録名を変更するとき

- ① 登録名を変更する機器を▲・▼で選び、決定 を押す
- ② ◀・▶で「はい」を選び、決定 を押す
- ③ 文字入力画面で登録名を入力する
 - ・文字入力の方法は、(P.38) をご覧ください。

登録を解除するとき

- ① 登録を解除する機器を▲・▼で選び、赤 を押す
- ② ◀・▶で「はい」を選び、決定 を押す
 - 録画予約が設定されている USB ハードディスクの登録を解除するときは、以下の画面が表示されます。
 - ・他の登録済 USB ハードディスクが接続されているとき
録画先の変更を促すメッセージ付の登録解除画面が表示されます。
 - ・他の登録済 USB ハードディスクが接続されていないとき
再登録を促すメッセージ付の登録解除確認画面が表示されます。

省エネ設定

- 複数の USB ハードディスクに対して個別に設定を変えることはできません。
 - ※ 「省エネモード」に設定した場合、USB ハードディスクが動作するまでに時間がかかることがあります。「ハードディスクがありません。」や、録画可能時間が「—時間—分」と表示されるような場合は、少し待ってから操作して下さい。
 - ※ USB ハードディスクによっては、機器の表示ランプが「待機」と「入」の状態を正しく示さないことがあります。
 - ※ USB ハードディスクによっては、「オフ」に設定していても、USB ハードディスク側の省エネ機能によって、待機状態になることがあります。
 - ※ 本機の電源が「切」または「待機」のときでも、「自動スキャン」や「番組情報の取得」が内部で動作している場合には、USB ハードディスクの電源が「入」になることがあります。
 - ※ USB ハブを使用している場合、本機の電源が「切」または「待機」のときでも、USB ハブからの電源供給によって、USB ハードディスクの電源が「入」になることがあります。
- ① ▲・▼で以下から選び、決定 を押す
 - ・オン …… USB ハードディスクの電源は、使用しない状態がしばらく続くと待機状態になり、使う操作をすると自動的に「入」になります。
 - ・オフ …… 本機の電源が「入」のとき、USB ハードディスクの電源は常時「入」の状態です。

機器の取りはずし

- USB ハードディスクの電源を切ったり、接続ケーブルを抜いたりするときには、その前にこの操作をします。
- ① 取りはずす機器を▲・▼で選び、決定 を押す
 - ② 確認画面で、◀・▶で「はい」を選んで決定 を押す
 - ・停止の処理が始まり、終了すると「USB ハードディスクを取りはずしできます。」のメッセージが表示されます。
 - ③ USB ハードディスクを取りはずし、決定 を押す

USBハードディスクの接続をする (つづき)

動作テスト

● USBハードディスクで以下の動作ができるかテストします。

① テストする機器を▲・▼で選び、決定を押す

● テストが始まります。終了までに数分間かかります。

● テストが終わると結果が表示されます。テスト結果が「OK」となった動作ができます。

- ・ 録画・・・・・・・・・・・・・ハイビジョン画質で録画ができるか
- ・ 録画中の再生・・・・・・・・・・ハイビジョン画質で録画しながら番組再生ができるか
- ・ 録画中の早見早聞・・・・録画中にハイビジョン番組の早見早聞 (P.59) ができるか、録画中に4K番組の再生ができるか

※ テスト結果は目安です。結果どおりの動作にならないことがあります。

機器の初期化

● 正常に使用できなくなったUSBハードディスクは、初期化をすれば使用できるようになることがあります。

※ 初期化をすると、USBハードディスクに保存されている内容はすべて消去されます。

① 初期化する機器を▲・▼で選び、決定を押す

② 初期化の確認画面で、◀・▶で「はい」を選んで決定を押す

③ 初期化終了の画面で決定を押す

録画の基本的な設定をする (つづき)

設定 > 録画・再生設定		
USBハードディスク設定	録画先機器の設定	USB1
録画設定	チャプター設定	本編
再生設定		
オートメディアプレーヤー		

● USBハードディスクでの録画・再生に関する基本的な設定をすることができます。

- 1、設定を押し、▲・▼と決定で「録画・再生設定」⇒「録画設定」の順に進む
- 2、以降の手順で設定する

録画に使用する機器を設定する

設定 > 録画・再生設定		
USBハードディスク設定	録画先機器の設定	USB1
録画設定	チャプター設定	本編
再生設定		
オートメディアプレーヤー		

● 複数のUSBハードディスクを本機に登録している場合に、録画に使用する機器を設定します。

① ▲・▼で「録画先機器の設定」を選び、決定を押す

録画先機器の設定	
USB 1	ハードディスク 2
USB 2	ハードディスク 1
◀で選び 決定で設定完了	

② 録画に使用する機器を▲・▼で選び、決定を押す

チャプター分割のしかたを設定する

- シーンの変わり目でチャプター分割（章分け）されるように設定できます。（チャプター分割をすると、再生時にチャプタースキップができるようになります）

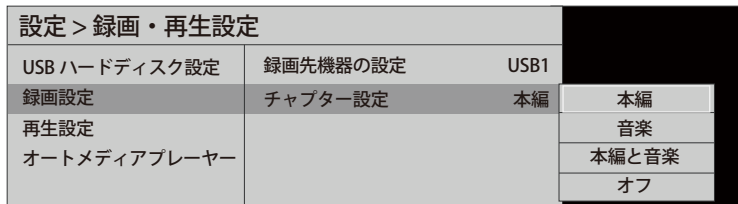

- ① ▲・▼で「チャプター設定」を選び、決定を押す
- ② チャプター分割の場面を▲・▼で選び、決定を押す

- ・ 本編・・・・・・・・・・本編とCMの間でチャプター分割されます。
 - ・ 音楽・・・・・・・・・・楽曲の前後でチャプター分割されます。
 - ・ 本編と音楽・・・・上記の両条件でチャプター分割されます。
 - ・ オフ・・・・・・・・・・チャプター分割をしません。
- ※ 音楽の検出は番組のメインジャンルが「音楽」または、メインジャンルが「バラエティ」でサブジャンルが「音楽バラエティ」のときにだけ行われます。

録画機器を使う

録画・予約をする

見ている番組を録画する

- 今見ているテレビ放送番組を簡単に録画することができます。テレビ番組視聴の途中で外出するような場合に便利です。
- 1、テレビ放送を見ているときにサブメニューを押し、▲・▼で「録画」を選び、決定を押す
 - 録画できない番組の場合は、サブメニューの「録画」は選べません。
 - 2、録画設定を変更する場合は、▲・▼・◀・▶で「その他の録画設定」を選んで決定を押す

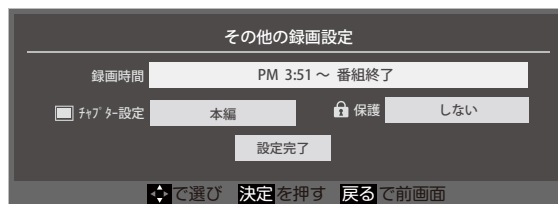
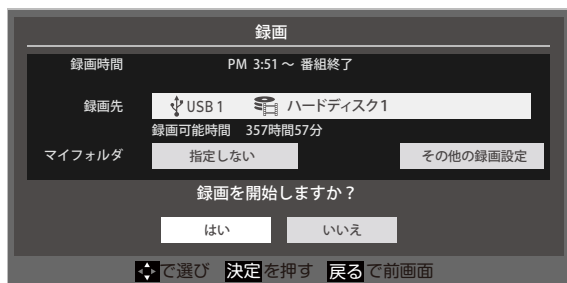

その他の録画設定でできる設定

● 録画時間の変更

お買い上げ時の設定では視聴中の番組が終了するまで録画されます。終了時刻を指定するには以下の操作をします。

- ① 「録画時間」で決定を押し、「時間指定」で録画終了時刻を設定して決定を押す
- ② 「設定完了」を選び、決定を押す

録画・予約をする (つづき)

録画予約や連ドラ予約の設定を変更する場合

- 「録画予約や連ドラ予約の設定を変更するとき」(P.52) をご覧ください。

3、▲・▼・◀・▶で「はい」を選び、決定を押す

- 録画が開始されます。
- 外出する場合は、本機(テレビ)の電源を「待機」または「切」にします。(録画は継続されます)

録画を中止するとき

- 録画を途中でやめるときは、以下の操作をします。録画予約での録画中の場合も同様です。
- USBハードディスクの残量がなくなった場合は録画が自動的に停止します。

① 録画中に終了または■を押す

② 「録画中止」の画面で、◀・▶で「はい」を選んで決定を押す

番組表で予約をする

- 番組表で録画したい番組を選んで予約します。

1、番組表を押して、番組表を表示させる

2、予約する番組を▲・▼・◀・▶で選び、決定を押す

- 番組指定予約画面が表示されます。

3、以下の操作で予約をする

- 録画機器や設定を変更する場合は、「録画予約や連ドラ予約の設定を変更するとき」(P.52)の操作をします。

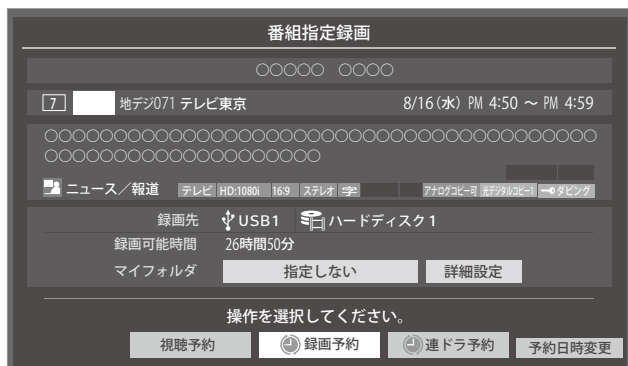

① ▲・▼・◀・▶で「視聴予約」、「録画予約」、「連ドラ予約」のどれかを選び、決定を押す

- ・ 視聴予約：指定した番組の視聴を予約します。
- ・ 録画予約：指定した番組の録画を予約します。
- ・ 連ドラ予約：同じ番組を毎回録画します。(P.50)

② 「予約を設定しました。」が表示されたら、決定を押す

予約する日時を変更する場合

- 再放送番組などで、1話から3話まで連続して放送される場合など、1話目を番組表で予約し、以下の操作で終了時間を3話目の終了時間に変更すると、1話から3話まで一つの録画予約にすることができます。

① ▲・▼・◀・▶で「予約日時変更」を選び、決定を押す

② メッセージが表示されたら、◀・▶で「はい」を選び、決定を押す

③ 「日時を指定して予約をする」(P.51)の手順3以降の操作をする

視聴制限番組について

- 視聴制限番組について、詳しくは「視聴できる番組を制限する」(P.119)をご覧ください。
- 番組表で視聴制限を一時解除するときは、「番組表で視聴制限を一時解除する」(P.22)をご覧ください。

メッセージが表示された場合

「設定した時間帯はこれ以上予約ができません。」が表示された場合

- ① ◀・▶で「はい」を選び、決定を押す
 - 新規予約をやめる場合は、「いいえ」を選びます。

「予約数がいっぱいです。」が表示された場合

- ① 決定を押す
- ② 「予約の確認・変更・取り消しをする」(P.54) の操作で予約を一つ以上取り消してから、再度予約をする

マルチ表示の番組表で予約するとき

- 一つの放送局で別の番組を放送している場合、その番組を予約するには番組表を「マルチ表示」(P.19) に切り換えます。
- マルチ表示の番組表で同じ番組が並んでいる場合は、どちらを選択しても予約できます。



お知らせ・・

- 放送局の変更があった場合、予約どおりに動作しないことがあります。
- 複数の番組が連続して予約されている場合、番組の最後の部分が録画されません。
- 予約をした時間帯は番組表に赤色の帯で表示されます。(P.17)
- 予約の確認や取り消しについては (P.54) を、予約の優先順位については (P.55) をご覧ください。

連続ドラマを予約する

● 連続ドラマや連日放送されている同じ番組などを、毎回自動的に録画されるように予約することができます。

※ 録画機器が USB ハードディスクの場合に連ドラ予約ができます。

ご注意・・

● 本機では、PPV（ペイ・パー・ビュー）番組の連ドラ予約を禁止しています。PPV（ペイ・パー・ビュー）番組を連ドラ予約した場合、録画は実行されません。

1、番組表 を押して、番組表を表示させる

2、連ドラ予約をする番組を▲・▼・◀・▶で選び、決定 を押す

● 現在放送中の番組を選んだ場合は「番組指定録画」画面が、これから放送される番組を選んだ場合は、「番組指定予約」画面が表示されます。

3、番組の録画先を USB ハードディスクに設定する

● 「録画予約や連ドラ予約の設定を変更するとき」（P.52）の操作で、「録画先」を設定します。

4、▲・▼・◀・▶で「連ドラ予約」を選び、決定 を押す

● 画面の図は、「番組指定予約」画面の場合の例です。

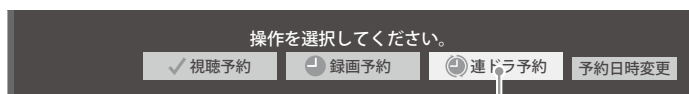

ここを選びます。

5、「連ドラ予約」画面で内容を確認する

● 番組名（連ドラ）や追跡基準の曜日などが正しく表示されているか確認してください。

「連ドラ予約」がより正しく実行されるために

「録画予約や連ドラ予約の設定を変更するとき」（P.52）の操作で「連ドラ設定」の画面を表示させ、「追跡キーワード」の確認・編集をすることをおすすめします。

6、▲・▼・◀・▶で「はい」を選び、決定 を押す

7、「予約を設定しました。」が表示されたら、決定 を押す

視聴中の番組を連ドラ予約する場合

① サブメニュー を押し、▲・▼で「連ドラ予約」を選んで決定 を押す

② 手順 5～7 の操作をする

連ドラ予約の動作について

● 連ドラ予約は、追跡基準（指定した番組の放送曜日と開始時刻）と、追跡キーワード（番組名など）を基に、次回の番組を検索して自動的に録画予約をする機能です。

※ 追跡基準（開始時刻）の前後約 2 時間が検索されます。

● 追跡キーワードには連ドラ予約をした番組の番組名、追跡基準には番組の放送時間が自動で設定されます。

お知らせ・・

● 電源を「入」にしてからしばらくの間は連ドラ予約ができません。

● 連ドラ予約後に、番組情報が取得できなくなった場合や、追跡キーワードに該当する番組が検出できなかった場合は録画されません。

● 漢字の旧字などの特殊な文字は表示されないことがあります。

● 予約の確認や取り消しについては（P.54）を、予約の優先順位については（P.55）をご覧ください。

日時を指定して予約をする／番組を検索して録画・予約をする

日時を指定して予約をする

1、サブメニュー を押し、▲・▼で「予約リスト」を選んで 決定 を押す

2、青 を押す

● 日時指定予約画面が表示されます。

● 視聴制限番組は表示されません。

表示させるときは、緑 を押して、視聴制限一時解除してください。

3、録画予約の日時を設定する

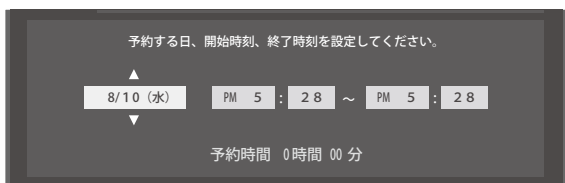

① 設定する項目を◀・▶で選び、▲・▼で日時を設定する

● 6週間先まで指定できます。

● 特定の日のほかに、「毎日」、「毎週（日）」～「毎週（土）」、「月～木」、「月～金」、「月～土」などの繰り返し録画も選べます。

● 設定できる時間は最大 23 時間 59 分です。

② 設定が終わったら、決定 を押す

4、録画するチャンネルを設定する

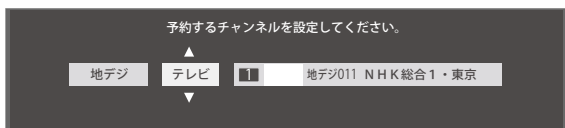

① 設定する項目を◀・▶で選び、▲・▼で内容を選ぶ

・ 放送の種類・・・地デジ／BS／CS／BS/CS 4K

・ 放送メディア・・・テレビ／ラジオ（BS、110度CS だけ）／データ

・ チャンネル・・・指定された放送の種類やメディアに該当するチャンネル

② 設定が終わったら、決定 を押す

5、録画設定を変更する場合は、(P.52) の手順で操作をする

6、▲・▼・◀・▶で「視聴予約」または「録画予約」を選び、決定 を押す

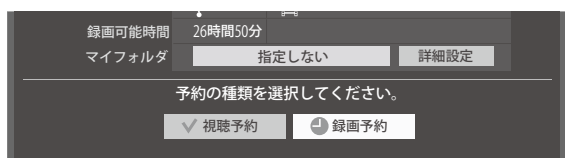

7、「予約を設定しました。」が表示されたら、決定 を押す

メッセージなどが表示された場合

● 「設定した時間帯はこれ以上予約ができません。」「予約数がいっぱいです。」のメッセージ表示された場合の操作については、(P.49) をご覧ください。

日時を指定して予約をする／番組を検索して録画・予約をする

番組を検索して録画・予約をする

- 1、番組表 を押して、番組表を表示させる
- 2、緑（番組検索） を押す
 - 番組検索画面が表示されます。

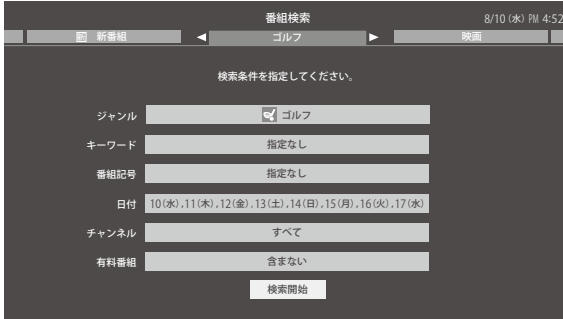

- 3、「条件を絞りこんで番組を探す」(P.23) の手順 3～5 の操作をして、録画・予約したい番組を検索する
- 4、「番組検索結果」画面から録画したい番組を▲・▼で選び、決定 を押す



5、録画・予約をする

- 操作方法は、「番組表で予約をする」(P.48) の手順 3 と同じです。
- 放送予定の番組を選んで予約をした場合には、「番組検索結果」の画面に戻ります。ほかの番組の予約を続けることができます。

お知らせ.....

- 日時指定予約では放送時間連動の設定はできません。
- 予約の確認や取り消しについては (P.54) を、予約の優先順位については (P.55) をご覧ください。

録画予約や連ドラ予約の設定を変更するとき

- 1、録画・録画予約・連ドラ予約画面などで、「その他の録画設定」を▲・▼・◀・▶で選び、決定 を押す
 - 録画・録画予約の「録画先」、「マイフォルダ」の設定は、画面上の「録画先」、「マイフォルダ」を選んで変更します。

「録画先」を変更するとき

- ① 録画・録画予約画面で、「録画先」を▲・▼・◀・▶で選び、決定 を押す
- ② ▲・▼で設定したい録画先を選び、決定 を押す

「マイフォルダ」を変更するとき

- ① 録画・録画予約画面で、「マイフォルダ」を▲・▼・◀・▶で選び、決定 を押す
- ② ▲・▼で設定したいフォルダグループを選び、決定 を押す

2、設定する項目を▲・▼・◀・▶で選び、決定 を押す

※ そのときの状況によって、設定や変更ができない項目があります。

3、▲・▼で内容を選び、決定 を押す

4、▲・▼・◀・▶で「設定完了」を選び、決定 を押す

項目	内容
録画先	<ul style="list-style-type: none"> 録画をする機器を選びます。
マイフォルダ	<ul style="list-style-type: none"> 番組の再生時に探しやすくするために、録画時にフォルダ分けします。再生のときに録画リストを「マイフォルダ別」の表示にすれば、保存した「マイフォルダ」の中から番組を探すことができます。「マイフォルダ」の名称は変更することができます。(P.66)
CHAPTER設定	<ul style="list-style-type: none"> 「本編」に設定すると、本編とCMの間でCHAPTER(章)が分割されます。 「音楽」に設定すると、楽曲の前後でCHAPTERが分割されます。(メインジャンルが「音楽」またはメインジャンルが「バラエティ」でサブジャンル「音楽バラエティ」のときのみ) 「本編と音楽」に設定すると、「本編」と「音楽」の両方の条件でCHAPTERが分割されます。 CHAPTERの機能を使わないときは、「オフ」に設定します。 録画済の番組でCHAPTER編集をすることもできます。(P.65) <p>※ 番組内容などによってはCHAPTER分割ができなかったり、分割位置がずれたりすることがあります。</p> <p>※ CHAPTER数の上限(100個)に達すると、それを超えるCHAPTERの作成はできなくなります。</p>
保護	<ul style="list-style-type: none"> 録画する番組を保護する(消さないようにする)かどうかを設定します。録画後に設定することもできます。(P.65)
連ドラ	<ul style="list-style-type: none"> 文字入力画面が表示され、必要に応じて連ドラの名称を編集することができます。(再生の際に「連ドラ別」の録画リストから番組を探しやすい名称などに編集します) 文字入力のしかたは、(P.38)をご覧ください。 連ドラの名称(連ドラグループ名)はあとで変更することもできます。(P.66)
追跡キーワード	<ul style="list-style-type: none"> 文字入力画面が表示され、必要に応じて連ドラ予約の追跡キーワードを編集することができます。(1回の放送に限られるようなキーワードは削除しておきます)
追跡基準	<ul style="list-style-type: none"> 必要に応じて、連ドラ予約をする番組の録画曜日と時間を設定することができます。
上書き録画	<ul style="list-style-type: none"> 連ドラ予約の場合に上書き録画の設定をします。上書き録画にすると前回の録画番組が削除されます。
放送時間	<ul style="list-style-type: none"> 放送局から番組遅延の情報が送信されると、最大3時間までの遅れに連動して録画をする機能です。(放送時間の繰り上げには対応できません) ほかの予約と時間帯の一部が重なったときの優先順については(P.55)をご覧ください。

予約の確認・変更・取り消しをする

● 予約の確認や取り消し、録画設定や連ドラ設定の変更をすることができます。

1、サブメニューを押し、▲・▼で「予約リスト」を選んで決定を押し

● 視聴制限番組は表示されません。

表示させるときは、緑を押して、視聴制限一時解除してください。

2、予約の確認や変更、取り消しをする番組を▲・▼で選び、決定を押し



録画や予約状況、上書き保存などのアイコンが表示されます。
 1 2 は放送時間変更などで同一の有料番組に予約が重複したときに表示されます。この場合、録画されるのは一つです。

3、以下の操作をする

予約を取り消すとき

① ◀・▶で「はい」を選び、決定を押し

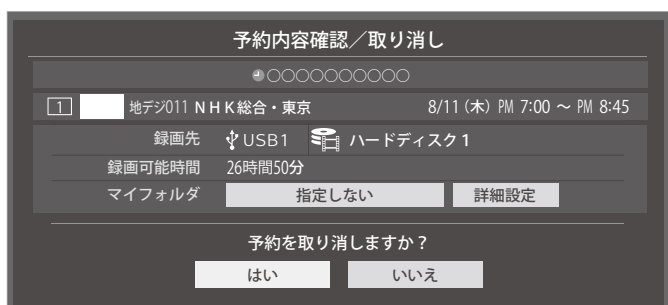

※ BS・110度CSの4K放送PPV（ペイ・パー・ビュー）番組の予約を取り消しても、購入手続きは取り消されません。（予約を取り消しても購入情報が残ります）

録画設定を変更するとき

● (P.52) の「録画予約や連ドラ予約の設定を変更するとき」の操作をします。

インターネットを利用するための接続をする

連ドラ予約を取り消すとき

- ① ◀・▶で「はい」を選び、決定を押す

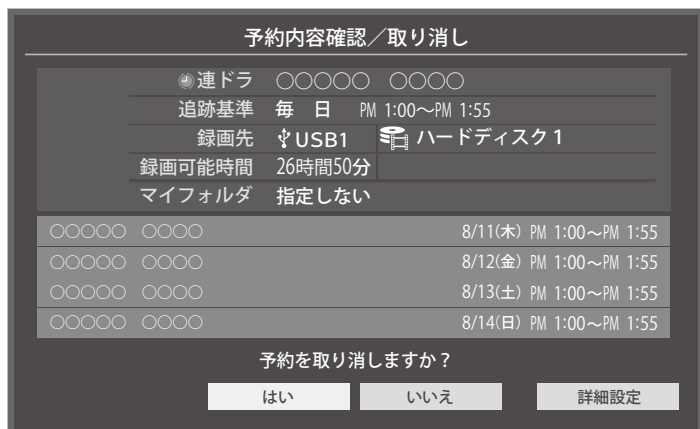

※ 連ドラ予約を取り消すと、直近の録画予約番組（録画中を含む）から予約が取り消されます。

予約内容を変更する場合

- ① ▲・▼・◀・▶で「詳細設定」を選び、決定を押す
- ② ▲・▼で設定を変更する項目を選び、決定を押す
- 設定画面に表示されている項目の内容については、(P.52)の「録画予約や連ドラ予約の設定を変更するとき」の表を参照してください。
- ③ ▲・▼・◀・▶で「設定完了」を選び、決定を押す

録画機器を使う

予約・録画の優先順位と予約の動作について

予約・録画の優先順位について

「録画予約」が最優先されます

- 録画予約と他の録画や視聴予約などが重なった場合、録画予約が優先されて、他の録画や視聴予約は中止または取り消しになります。

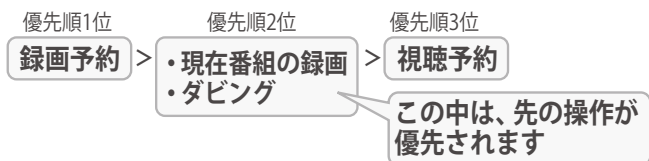

放送時間に変更されたとき

「放送時間」を「連動する」に設定した予約番組と「連動しない」に設定した番組が重なった場合

- 「放送時間」を「連動する」に設定した番組が優先されます。
例 「放送時間」を「連動する」に設定していた予約Aが時間変更に対応したため、予約Aと重なった部分の予約Bは録画されません。

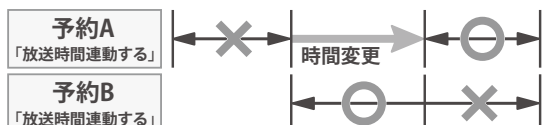

予約・録画の優先順位と予約の動作について

「放送時間」を「連動する」に設定した複数の予約番組が重なった場合

① 開始時刻が変更された場合

- 開始時刻の早い予約が優先されます。

例 予約Aの変更後の開始時刻よりも、予約Bの開始時刻が早くなるので、予約Aは取り消されます。

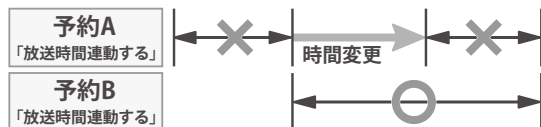

② 放送時間が延長された場合

- 先に録画を開始した番組の時間延長が優先されます。

例 先に録画を開始し、放送時間延長に対応した予約Aが優先されます。

開始時刻の遅い予約Bは取り消されます。

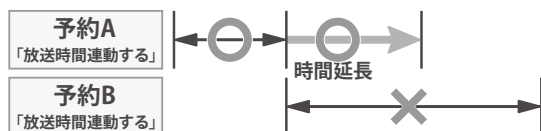

③ 複数の予約番組の開始時刻が同じになった場合

- 最初に予約設定した番組が優先され、2番目以降に設定した番組の予約は取り消されます。

- 番組情報が更新されるタイミングによっては正しく録画されないことがあります。
- 終了時刻が未定のままで、継続して録画される時間は3時間までです。
- 番組情報(放送時間)が変更され、「録画予約」と「連ドラ予約」が同時刻で重なった場合は「録画予約」が優先録画されます。

予約の動作について

- 予約設定後、本機の動作は以下のようになります。

予約した番組放送が始まる時

- 予約を中止する場合は、終了または ■ を押します。
- 録画予約の場合は、予約した番組のチャンネルに切り換わることがあります。
- 予約した視聴制限のある番組が始まる時は、メッセージが表示されます。決定 を押し、暗証番号 (P.119) を入力してください。

予約した番組の放送中

- 録画予約した番組の録画中に操作できないボタンを押すと、録画中を知らせるメッセージが表示されます。
- 録画予約した番組の録画が始まると、上記の優先順に従って他の録画は中止されます。

予約した番組の終了後

- 本機を通常どおり使用できます。

録画した番組を再生する

録画した番組を再生する

● USBハードディスクに録画した番組を見るには、以下の操作をします。

再生の基本操作とさまざまな再生のしかた

1、録画リスト を押す

2、必要に応じて録画リストの表示を変える

● 分類タブとグループタブについては、下の図を参照してください。

① <<・>> で分類タブを切り換える

- ・ すべて・・・・・・・・すべての録画番組が表示されます。
- ・ 未視聴・・・・・・・・未再生の録画番組が表示されます。
- ・ 曜日別・・・・・・・・録画した曜日ごとに表示されます。
- ・ ジャンル別・・・・・・・・ドラマや映画などのジャンルごとに表示されます。

番組情報がない場合は、「その他」に分類されます。

- ・ 連ドラ別・・・・・・・・「連ドラ予約」の予約ごとに表示されます。
- ・ マイフォルダ別・・・・指定した「マイフォルダ」ごとに表示されます。

② ◀・▶でグループタブを切り換える

- 分類が「すべて」「未視聴」の場合はグループタブはありません。
- 分類が「すべて」以外の場合は、分類タブとグループタブで選ばれた番組だけリストに表示されます。
- 分類が「未視聴」の状態、録画リストを表示しなおした場合、分類は「すべて」の状態になります。
- 視聴年齢制限番組は表示されません。表示させるときは、サブメニューを押してから、「視聴制限一時解除」を選んで決定を押してから暗証番号を入力してください。

3、見たい番組を▲・▼で選び、決定 を押す

- 選んだ番組の再生が始まります。
- 前回、再生を途中で停止した番組を選んだ場合は、続きから再生されます(レジューム再生)。
- 番組を最後まで再生し終わると、そのまま静止状態になり、しばらくするとテレビの放送になります。
- 再生中にできるリモコン操作については、(P.59)をご覧ください。

4、番組再生を終了するには、■ (停止)または終了 を押す

- 放送画面などに戻ります。

番組の冒頭から再生する一頭出し再生

① 再生する番組を選んでから、サブメニュー を押し、▲・▼で「頭出し再生」を選んで決定 を押す

録画中の番組を再生する一追っかけ再生

① 録画中の番組を▲・▼で選んで決定 を押す

録画した番組を再生する (つづき)

チャプターの一覧画面から再生する

● チャプターが分割されている録画番組でできます。

※ BS・110度CSの4K録画番組は、「チャプター一覧画面」の操作はできません。

① 再生する番組を▲・▼で選んで緑を押す

● チャプター一覧画面が表示されます。

② 再生するチャプターを▲・▼・◀・▶で選んで決定を押す

● 選択したチャプターの先頭から再生が始まります。

再生中にタイムサーチで再生位置を指定する

① サブメニューを押し、▲・▼で「サーチ」を選んで決定を押す

● 画面右上に[サーチ -- : -- : --]が表示されます。

② 1 ~ 10 (0) で時間を指定する

例

冒頭から1時間25分5秒後の位置を指定するとき

10 (0) 1 2 5 10 (0) 5 の順に押します。

録画リスト (例)

分類タブ

グループタブ
分類タブが「すべて」と「未視聴」では表示されません。

使用中の機器

選択中の録画番組が再生画面に表示されます。

選択中の録画番組の情報

自動削除機能が有効のときに表示

機器の情報

操作ガイド

録画リスト (例)

選んだ番組の番号/録画番組数

番組の並び順

放送日

録画中アイコン

未再生の番組 NEW

上書きアイコン

コピー制御アイコン

各マイフォルダのアイコン

保護アイコン

お知らせ.....

● 番組冒頭部分の約2秒間を飛ばして再生が始まります。(録画は番組開始時刻の約2秒前から開始されるようになっています)











■ 録画リストについて

● 録画開始直後の番組は、録画リストに表示されるまでに少し時間がかかります。

● 録画リストに表示できる最大数は、3000件までです。これを超えた機器では正しく動作しないことがあります。

● 機器に記録されている情報によっては、選択中の録画番組の情報が正しく表示されないことがあります。

録画番組の再生中にできるリモコン操作

ボタン	内容
 早見早聞	一時停止、早送り/早戻し再生から通常の再生に戻します。 <ul style="list-style-type: none"> 再生中に繰り返し押し出すと、1.5倍の速さの音声付早送り再生「早見早聞」と通常の再生が交互に切り換わります。 放送番組の視聴中に押し出すと、USBハードディスクで前回再生した番組の続きから再生されます。
 静止	再生中に押し出すと一時停止になり、もう一度押し出すと再生が再開されます。
 停止	再生を終了し、放送画面などに戻ります。
 早送り	早送り再生をします。(押し出すたびに速さが変わります) <ul style="list-style-type: none"> 一時停止中に押し出すとコマ送りができます。 一時停止中に1秒ほど押し続けるとスロー再生になります。スロー再生中に押し出すと、押し出すたびにスロー再生の速さが変わります(3段階)。
 早戻し	早戻し再生をします。(押し出すたびに速さが変わります) <ul style="list-style-type: none"> 一時停止中に押し出すと0.5秒ほど戻って一時停止になります。番組によっては、戻る時間が大きくなることがあります。 一時停止中に1秒ほど押し続けると連続コマ戻し再生になります。
	再生中に押し出すと、20ポイントに分割された番組の前後のポイントへスキップします。 <ul style="list-style-type: none"> 録画時間が短い番組では動作しないことがあります。
 30秒送り	再生中または早見早聞での再生中に押し出すと、30秒ほど先に進んで再生します。(ワンタッチスキップ)
 10秒戻し	再生中または早見早聞での再生中に押し出すと、10秒ほど戻って再生します。(ワンタッチリプレイ)
 スキップ	次のチャプターの先頭にスキップして再生します。 <ul style="list-style-type: none"> チャプターのない録画番組では録画日時が一つ次の番組を再生します。
 スキップ	現在のチャプターの先頭にスキップして再生します。再生してから4秒以内に押した場合は、一つ前のチャプターの先頭にスキップします。 <ul style="list-style-type: none"> チャプターのない録画番組では再生中の番組の先頭に戻って再生します。再生してから4秒以内に押した場合は、録画日時が一つ前の番組の先頭にスキップします。
 録画リスト	再生中に押し出すと、録画リストが表示されます。 <ul style="list-style-type: none"> 放送番組視聴時などに押した場合も録画リストが表示されます。

※ BS・110度CSの4K録画番組は、「早見早聞」「スロー再生」「連続コマ戻し再生」「コマ送り」「コマ戻し(0.5秒戻し)の操作はできません。

※ 録画番組によっては、「早見早聞」が正しく動作しないことがあります。

※ 録画中の番組再生での早送り/早戻し再生などの特殊再生機能は、正しく動作しないことがあります。

録画した番組を再生する (つづき)

※ 録画番組を特殊再生しているときは、字幕の表示ができません。

※ 録画番組によっては、一時停止やワンタッチスキップなどの特殊再生操作をしたときに映像が表示されなくなることがあります。その場合は、▶ (早見早聞) で通常再生に戻してから再度特殊再生の操作をしてください。

ワンタッチスキップ/ワンタッチリプレイの時間を変更する

● ワンタッチスキップとワンタッチリプレイの時間を変更することができます。お買い上げ時の設定のように、飛ばす時間よりも戻す時間を短く設定しておくこと、飛ばしすぎて戻すときに便利です。

- ① 設定 を押し、▲・▼と決定で「録画・再生設定」⇒「再生設定」の順に進む
- ② ▲・▼で「ワンタッチスキップ設定」または「ワンタッチリプレイ設定」を選び、決定 を押す
- ③ ▲・▼で時間を選び、決定 を押す

録画番組の情報や番組説明を見る

番組の情報を見る

- ① 再生中に 画面表示 を押す
- 再生中の番組の情報が表示されます。
- しばらくすると番組情報の表示は消えます。

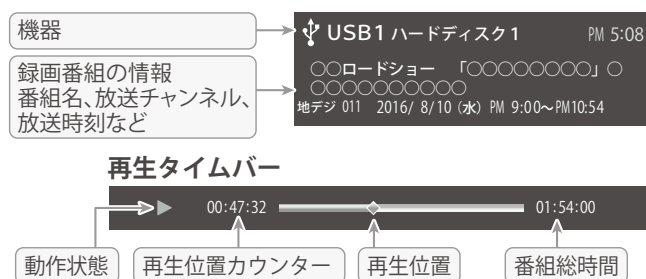

- ② 表示を消すには、もう一度 画面表示 を押す

番組説明を見る

- ① 番組説明 を押す
 - 番組説明画面が表示されます。
 - ・ サブメニュー を押し、▲・▼と決定で「番組説明」を選んでも同様の操作ができます。
- ② 番組説明画面を消すには、終了 を押す
 - しばらく放置した場合にも消えます。

録画番組を修復する

● 録画中に停電したり、電源プラグを抜いてしまったりすると録画番組が正しく保存されず、そのままでは再生できません。このような場合、「録画番組の修復」をすると、録画された内容を再生できるようになることがあります。

- ① 設定 を押し、▲・▼と決定で「録画・再生設定」⇒「USBハードディスク設定」の順に進む
- ② ▲・▼で「録画番組の修復」を選び、決定 を押す
- ③ 番組を修復する機器を▲・▼で選び、決定 を押す
- ④ 確認画面で、◀・▶で「はい」を選び、決定 を押す
 - 修復の処理が始まります。終わるまでそのままお待ちください。

⑤ 「録画番組の修復を行いました。」が表示されたら、決定を押す

● この操作には、30分程度かかる場合があります。

● 録画番組を修復できなかった場合は、「録画番組の修復ができませんでした。」が表示さ

※ 録画番組が修復できた場合でも、通常再生以外の再生機能は正しく動作しないことがあります

再生する

見たい録画番組を探して再生する

● USBハードディスクに録画した番組の中から、視聴したい番組を探することができます。

● ジャンル、キーワードなどの検索条件を指定して録画番組を検索します。

● 録画番組のグループ（タブ）ごとに検索条件を設定できます。

1、録画リストの表示中にサブメニューを押す

2、▲・▼で「番組検索」を選び、決定を押す

● 録画番組検索画面が表示されます。

3、検索するグループのタブを◀・▶で選ぶ



4、検索条件を指定する

● 「ジャンル」、「キーワード」、「番組記号」の指定方法は、「条件を絞りこんで番組を探す」（P.23）の手順4と同じです。ほかの項目は以下の手順で指定します。

「日付」を指定するとき



① ▲・▼で「日付」を選び、決定を押す

② ◀・▶で左端の欄に移動し、▲・▼で「指定する」を選ぶ

③ ◀・▶で欄を移動し、検索範囲の開始～終了の年、月、日を▲・▼で選ぶ

④ 指定が終わったら、決定を押す

見たい録画番組を探して再生する (つづき)

「チャンネル」を指定するとき

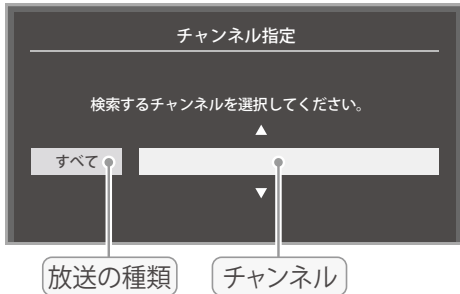

- ① ▲・▼で「チャンネル」を選び、決定を押す
- ② 指定する項目を◀・▶で選び、▲・▼で内容を選ぶ
 - ・放送の種類・・・すべて / BS / CS / 地デジ / BS/CS 4K
 - ・チャンネル・・・指定した放送の種類に該当するチャンネル / すべて
- ③ 指定が終わったら、決定を押す

5、▲・▼・◀・▶で「検索開始」を選び、決定を押す

- 検索にはしばらく時間がかかることがあります。
- 検索が終わると、検索結果画面が表示されます。

6、見たい録画番組を▲・▼で選び、決定を押す



- 選んだ番組の再生が始まります。

録画リストのさまざまな機能を使う

- 録画リストの表示中に以下のさまざまな機能を使うことができます。

繰り返し再生の設定を変える

- 録画番組の繰り返し再生（リピート再生）を設定することができます。
- 設定した状態は本機に記憶されます。

1、サブメニューを押し、▲・▼で「再生設定」を選んで決定を押す

2、▲・▼で以下から選び、決定を押す

- ・ 1コンテンツリピート・・・選択した一つの番組の再生を繰り返します。
- ・ リピート・・・すべての番組の連続再生を繰り返します。
- ・ オフ・・・繰り返し再生をしません。

- リピート再生をしているときは、画面左上にリピート再生アイコンが表示されます。
(1コンテンツリピート：↺1、リピート：↺)

- 録画中の番組はリピート再生ができません。

番組を並べ替える

- 録画リストに表示される番組の並び順を変えることができます。
- 1、サブメニュー を押し、▲・▼で「並べ替え」を選んで 決定 を押す
 - 2、▲・▼で以下から選び、 決定 を押す
 - ・ 新しい順 日付の新しい順に表示されます。
 - ・ 古い順 日付の古い順に表示されます。

ほかの機器を選択する

- 再生する機器を変更するには以下の操作をします。
- 1、青 を押す
 - 機器選択画面が表示されます。
 - ※ 機器が1台しか接続されていない場合は、メッセージが表示されます。
 - 2、使用する機器を▲・▼・◀・▶で選び、 決定 を押す

連ドラ予約をする

- 録画リストに表示されている番組を選んで、「連ドラ予約」をすることができます。
- 1、連ドラ予約にする番組を▲・▼で選び、サブメニュー を押す
 - 2、▲・▼で「連ドラ予約」を選び、 決定 を押す
 - 3、「連ドラ予約」画面で内容を確認し、◀・▶で「はい」を選んで 決定 を押す
 - 番組名や追跡基準の曜日などが正しく表示されているか確認します。
 - 設定を変更する場合は、「録画予約や連ドラ予約の設定を変更するとき」(P.52)の操作をします。

機器の情報を確認する

- 使用中の機器の情報を確認します。
 - USBハードディスクの残量も画面で確認できます。
 - ※ 残量表示や録画可能時間表示は、あくまでも目安であり、保証するものではありません。
 - ※ USBハードディスクの残量は、BS・110度CSデジタルハイビジョン放送（24Mbps）とBS・110度CSの4K放送（33Mbps）の録画が可能な時間を基準に算出しています。
 - 地上デジタルハイビジョン放送（約17Mbps）の録画番組などを削除した場合、残量の増加分は削除した番組の時間よりも少なくなります。
- 1、サブメニュー を押し、▲・▼で「機器の情報」を選んで 決定 を押す
 - 機器の情報画面が表示されます。
 - 2、情報画面を消すには、 決定 を押す

不要な録画番組を消す／誤って消さないように保護する

不要な録画番組を消す／誤って消さないように保護する

- 見終わった録画番組などを消したり、消さないように保護したりする場合は、録画リストの表示中に以下の操作をします。

一つの録画番組を消す

- 1、消す番組を▲・▼で選び、赤（削除）を押す

● 保護されている録画番組を消す場合は、保護を解除（P.65）してから赤を押してください

- 2、▲・▼で「1件削除」を選び、決定を押す
- 3、確認画面で、◀・▶で「はい」を選んで決定を押す

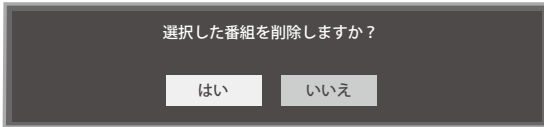

- 4、削除が終了したら、決定を押す

複数の録画番組を消す

- 1、消す番組のどれかを▲・▼で選び、赤（削除）を押す

- 2、▲・▼で「複数削除」を選び、決定を押す

- 3、消す番組を▲・▼で選び、決定を押す

● 決定を押すたびに、☑と☐が交互に切り換わります。削除する番組に☑をつけます。

● 保護された番組を消す場合は、その番組を選び、青を押して保護を解除してから決定を押します。

☑をつけた番組が削除されます | 青は保護解除してから



- 4、選択が終わったら赤（削除実行）を押す

- 5、確認画面で、◀・▶で「はい」を選んで決定を押す

- 6、削除が終了したら、決定を押す

4 グループ内の録画番組をすべて消す

- 1、まとめて消すグループの録画リストを表示させる

● 「録画した番組を再生する」（P.57）の手順2をご覧ください。

- 2、赤（削除）を押し、▲・▼で「グループ内全削除」を選び、決定を押す

- 3、確認画面で、◀・▶で「はい」を選んで決定を押す

- 4、削除が終了したら、決定を押す

自動的に消す（自動削除設定）

● お買い上げ時は、USBハードディスクの容量が足りなくなってきたときに、保護されていない古い録画番組が自動的に削除されないように設定されています。削除されるようにする場合は「削除する」に設定してください。

- 1、サブメニューを押し、▲・▼で「自動削除設定」を選んで決定を押し
- 2、▲・▼で「削除する」または「削除しない」を選び、決定を押し

誤って消さないように保護する

● 自動削除機能で削除されたり、誤って消してしまったりしないように、録画番組を保護することができます。

※ 録画中にこの操作はできません。

- 1、保護する番組を▲・▼で選び、サブメニューを押し
- 2、▲・▼で「保護」を選び、決定を押し
 - 選択した番組が保護されます。（🔒がつきます）
 - 保護されている番組を選択してサブメニューを表示させると、「保護解除」ができます。

編集・ダビングする

CHAPTER 編集をする

CHAPTER 編集をする

録画済番組の再生中に編集する

● 録画済番組の再生中にCHAPTERの分割と結合ができます。

- 1、録画リストを表示させる（P.57 1～2）
- 2、CHAPTER編集をする録画済番組を▲・▼で選び、決定を押し
- 3、各種の再生操作をして、CHAPTER分割をしたい場面で（静止）を押し



● 画面右下に操作ガイドと再生タイムバーが表示されます。

● ◀◀・▶▶でコマ送りやスロー再生ができます。

▶▶	<ul style="list-style-type: none">・一時停止中に押しとコマ送りができます。・一時停止中に1秒ほど押し続けるとスロー再生になります。スロー再生中に押すたびにスロー再生の速さが変わります（3段階）
◀◀	<ul style="list-style-type: none">・一時停止中に押しと0.5秒ほど戻って一時停止になります。・一時停止中に1秒ほど押し続けると連続コマ戻しになります。

グループ名を変更する

4、青または赤でチャプター編集をする

- 青を押すと、一時停止した場面でチャプターが分割されます。
- 赤を押すと、一時停止したチャプターとその前のチャプターが結合されます。
- 必要に応じて、手順3と4を繰り返します。

グループ名を変更する

- 「マイフォルダ別」の録画リストで表示されるグループのタブ名を変更することができます。
- 「連ドラ別」の場合にも同様の操作ができます。その場合は、グループ名を変更すると予約リストの予約番組名も同じ名前に変更されます。
- ハードディスクが複数接続されている場合、機器ごとにグループ名を変更することはできません。
- 番組の録画中にこの操作をすることはできません。

1、「マイフォルダ別」の録画リストを表示させる (P.57 1～2)

- 連ドラグループ名を変更する場合は、「連ドラ別」の録画リストを表示させます。

2、名前を変更するグループのタブを◀・▶で選ぶ

例「わたし」のグループを選択



3、サブメニューを押し、▲・▼と決定で「編集・管理」⇒「マイフォルダ管理」⇒「マイフォルダ名の変更」の順に進む

- 「連ドラ別」のグループ名を変更する場合は、「編集・管理」⇒「連ドラグループ名の変更」の順に進みます。

4、文字入力画面でグループ名を入力する

- お好みの分類名にすることができます。
- 文字入力の方法は、(P.38)をご覧ください。
- 全角文字で10文字まで入力できます。
- 文字入力の操作が終わると、録画リストのグループタブ名が変更されます。

例「わたし」⇒「まさみのお気に入り」に変更



ほかのグループに移動する

ほかのグループに移動する

● 録画番組をほかのグループに移動することができます。















たとえば、録画時の設定で「わたし」に分類した番組を、録画後に「お気に入り2」に移すことができます。

※ USBハードディスクでの録画中は、この操作はできません。

※ 保護された録画番組は、移動することはできません。

- 1、「マイフォルダ別」の録画リストを表示させる (P.57 1～2)
- 2、移動する番組が保存されているグループのタブを◀・▶で選ぶ
- 3、移動する番組を▲・▼で選ぶ
- 4、サブメニューを押し、▲・▼と決定で「編集・管理」⇒「マイフォルダ管理」⇒「マイフォルダの変更」の順に進む
- 5、▲・▼で以下から選び、決定を押し
 - ・ 1件変更・・・選択中の番組を別のグループに移動します。
 - ・ 複数変更・・・複数の番組を選択して、まとめて別のグループに移動します。
 - ・ グループ内全変更・・・選択中のグループの全番組を別のグループに移動します。
- 6、移動先のグループを▲・▼で選び、決定を押し

● グループアイコンとグループ一覧 (お買い上げ時の設定)

 みんな	 お気に入り1
 おとうさん	 お気に入り2
 おかあさん	 お気に入り3
 ぼく	 お気に入り4
 わたし	 お気に入り5
 おじいちゃん	 お気に入り6
 おばあちゃん	 指定しない

7、「複数変更」の場合は以下の操作をする

① 移動する番組を▲・▼で選び、決定を押し

- 決定を押すたびに、☑と☐が交互に切り換わります。移動する番組に☑をつけます。
- 保護されている番組は移動できません。

② 移動する番組をすべて選んだら黄を押す

8、確認画面で、◀・▶で「はい」を選んで決定を押し



録画番組をダビング (ムーブ) する

- 本機で USB ハードディスクに録画した番組を他の USB ハードディスクにダビングすることができます。
- ※ ダビング中に機器の接続を変更したり、電源プラグをコンセントから抜いたりしないでください。
- ※ ダビング中の番組は再生できません。

USB ハードディスク間でムーブする

- 録画リストを表示させる (P.57 1～2)
- ダビングする番組を▲・▼で選び、黄 を押す
- ▲・▼で「1 件ダビング」または「複数ダビング」を選び、決定 を押す
- ダビング先を▲・▼で選び、決定 を押す
 - ダビング先に指定できる機器が 1 台の場合、この手順はありません。
- 「複数ダビング」の場合は以下の操作をする
 - ダビングする番組を▲・▼で選び、決定 を押す
 - 決定 を押すたびに、とが交互に切り換わり、をつけた番組がダビングされます。
 - 保護された番組をダビングする場合は、その番組を選び、青 を押して保護を解除してから決定 を押します。

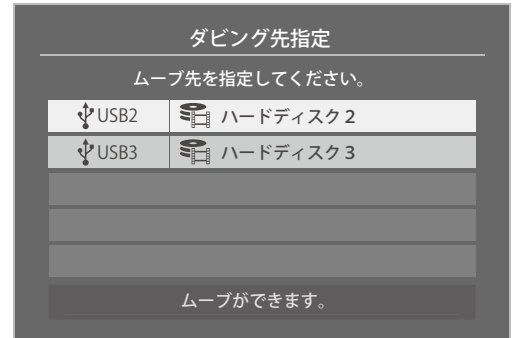

をつけた番組がムーブされます は青で解除してから



- ダビングする番組をすべて選んだら 黄 を押す
 - 一度にダビングできるのは 64 番組までです。

- 「ダビング」画面で、◀・▶で「はい」を選んで決定 を押す

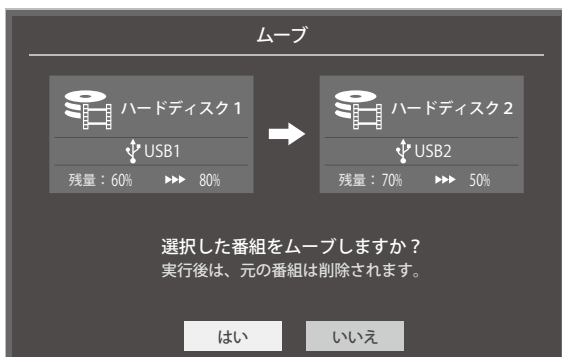

外部機器を接続する

外部機器接続例

- 接続が終わったら、「外部入力の機能を設定する」(P.74)を参照して必要な設定をしてください。
- HDMI 連動機器では、本機との連動機能によって、ワンタッチプレイやシステムスタンバイの機能を使ったり、本機のリモコンで機器の基本操作をしたりすることができます。詳しくは、「HDMI 連動について」(P.78)をご覧ください。必要に応じて「HDMI 連動機能」(P.79)の設定をしてください。
- AV アンプなどのオーディオ機器が ARC(オーディオリターンチャンネル)に対応している場合、従来必要だった光デジタルケーブルを無くし、ARC 対応の HDMI ケーブル 1 本で接続できます。ARC 対応していないオーディオ機器と HDMI ケーブルで接続する場合は、「HDMI 連動対応のオーディオ機器で聴くとき」(P.73)をご覧ください。

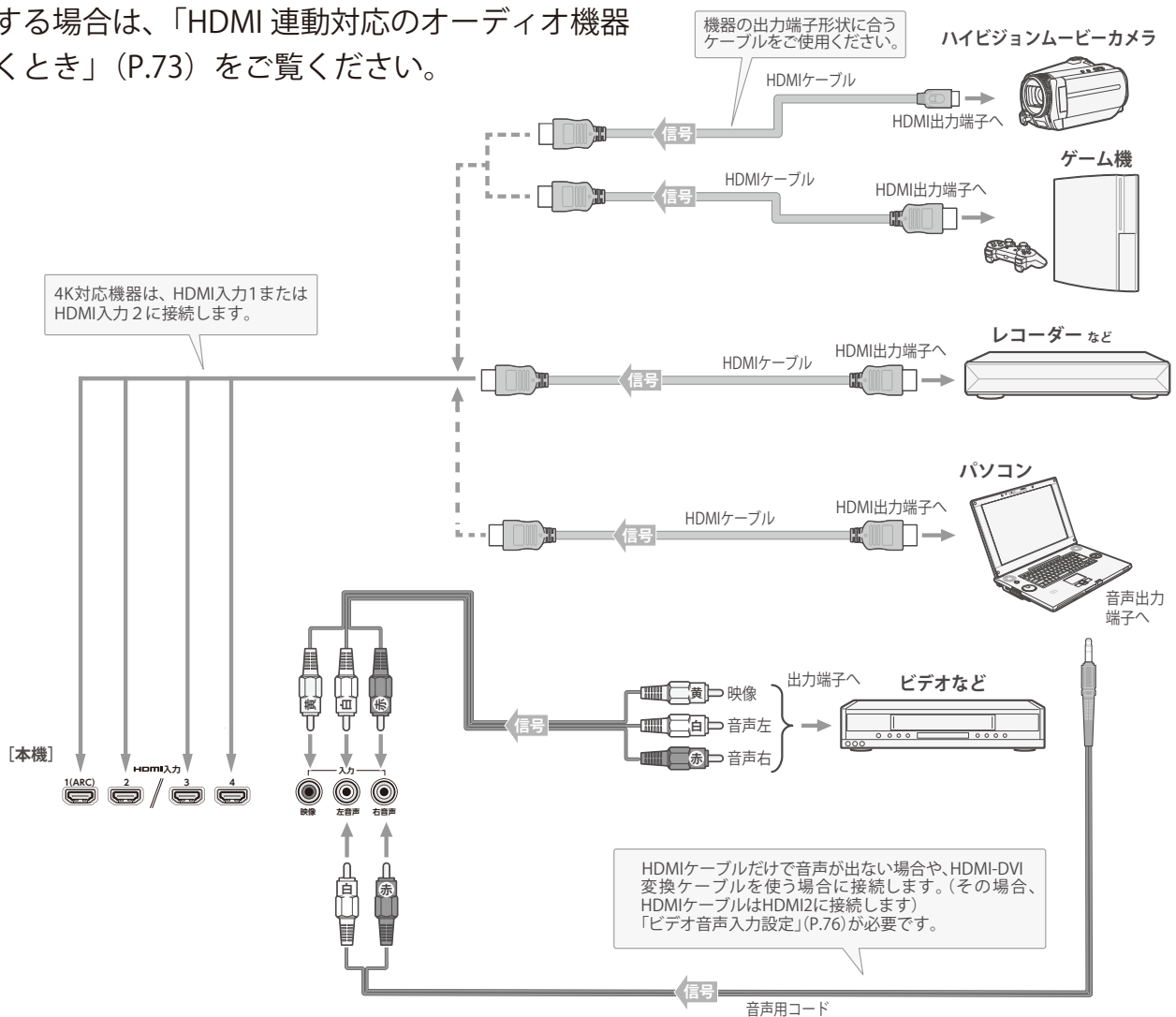



お知らせ.....

- 本機の HDMI 入力端子は、4K 映像機器にも対応しています。
- 本機の HDMI 入力端子が対応している入力信号および HDMI ケーブルについては次ページをご覧ください。
- HDMI 4K 入力については、すべての 4K 入力映像の表示を保証するものではありません。
- パソコンについて
 - 外部モニターで表示できるように設定し、本機が対応している HDMI 入力信号フォーマットの信号 (P.126) を入力してください。(本機が対応している信号を入力しても、パソコンによっては本機が認識できないことがあります)
 - パソコンの DVD 再生ソフトなどで再生した映像は、本機の画面で正しく表示されなかったり、映像の動きが不自然になったりすることがあります。

外部機器を接続する (つづき)

- 本機に接続できる接続ケーブル（接続コード）の種類と本機で対応している信号の種類および、これらの中で比較した画質・音質の関係を下表に示します。
 - 接続ケーブルの端子形状などは一例です。設置場所や機器の仕様などに合わせて、適切な市販品をご使用ください。
 - HDMI ケーブルは、HDMI ロゴの表示があるケーブルをご使用ください。
- ※ 外部機器から 1080p の映像信号を入力する場合は、ハイスピード HDMI® ケーブルをご使用ください。
- ※ 外部機器から 4K の映像信号 (2160p) を入力する場合は、プレミアムハイスピード HDMI® ケーブルをご使用ください。

接続ケーブル (接続コード)	画質・音質	本機の入出力対応信号
HDMIケーブル (入力用/ARC用) 	画質・音質 ともに最高	デジタル映像信号 480i、480p、720p、1080i、1080p、4K×2K デジタル音声信号(入力) リニアPCM、MPEG-2 AAC サンプリング周波数：48kHz、44.1kHz、32kHz ドルビーデジタル、ドルビーデジタルプラス サンプリング周波数：48kHz デジタル音声信号(ARC) リニアPCM、ドルビーデジタル、ドルビーデジタルプラス サンプリング周波数：48kHz MPEG-2 AAC サンプリング周波数：48kHz、44.1kHz、32kHz
映像・音声用 コード(入力用) 	画質・音質 ともに標準	アナログ映像信号 480i アナログ音声信号
音声用コード (入力用) 	標準の音質	アナログ音声信号
オーディオ用光 デジタルケーブル (出力用) 	最高の音質	デジタル音声信号(光) リニアPCM、ドルビーデジタル サンプリング周波数：48kHz MPEG-2 AAC サンプリング周波数：48kHz、44.1kHz、32kHz
音声用コード (出力用) 	標準の音質	アナログ音声信号

著作権保護について

- 本機の HDMI 入力端子は、HDCP で著作権保護されている映像の再生に対応しています。

対応 HDCP バージョン

- ・HDCP1.4、HDCP2.2

アナログ音声入力端子付のオーディオ機器で聴くとき

- ヘッドホン／音声出力端子を使って、アナログ音声入力端子付のオーディオ機器に接続することができます。
- 「ヘッドホン／音声出力設定」(P.111) の「出力設定」を「外部スピーカー」に設定してください。
- 「外部スピーカー出力設定」(P.111) で音量を「固定」または「可変」に設定することができます。

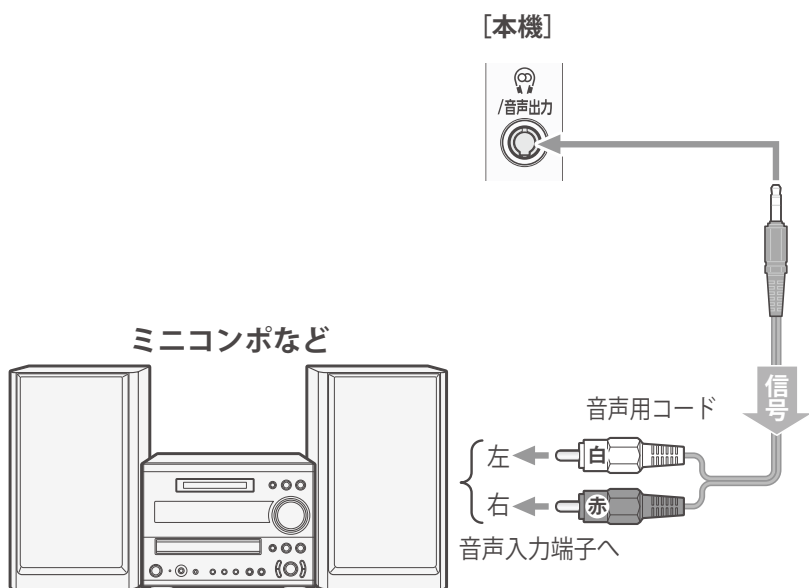

ご注意

- 接続する機器の取扱説明書もよくお読みください。
- 他の機器を接続するときは、必ず本機および接続する機器の電源を切り、電源プラグをコンセントから抜いてください。

お知らせ

■ヘッドホン／音声出力端子について

- ヘッドホン／音声出力端子には、音声調整の「低音強調」「サラウンド」「左右バランス」の効果は得られません。
(ドルビー DRC の効果は、ドルビーデジタル音声記録された映像ソフトなどの視聴時に得られます)

外部機器を接続する (つづき)

デジタル音声（光）端子付のオーディオ機器で聴くとき

- ミニコンポなどのオーディオ機器（サウンドシステム）に接続するとき
 - ・ 本機の音量を最小に調節し、ミニコンポなどのオーディオ機器（サウンドシステム）側で音量を調節してください。
 - ・ オーディオ機器が対応しているデジタル音声入力に従って、「デジタル音声出力」（P.110）の設定をします。
- サンプルレートコンバーター内蔵のMDレコーダーやDATに接続するとき
 - ・ MDレコーダーやDATの光デジタル音声入力端子に接続すれば、高音質で録音して楽しむことができます。
 - ・ 「デジタル音声出力」（P.110）を「PCM」に設定します。
- MPEG-2 AAC デコーダーに接続するとき
 - ・ デジタル放送のMPEG-2 AAC方式の信号を、MPEG-2 AAC デコーダーで楽しむことができます。
 - ・ 「デジタル音声出力」（P.110）を「デジタルスルー」に設定します。

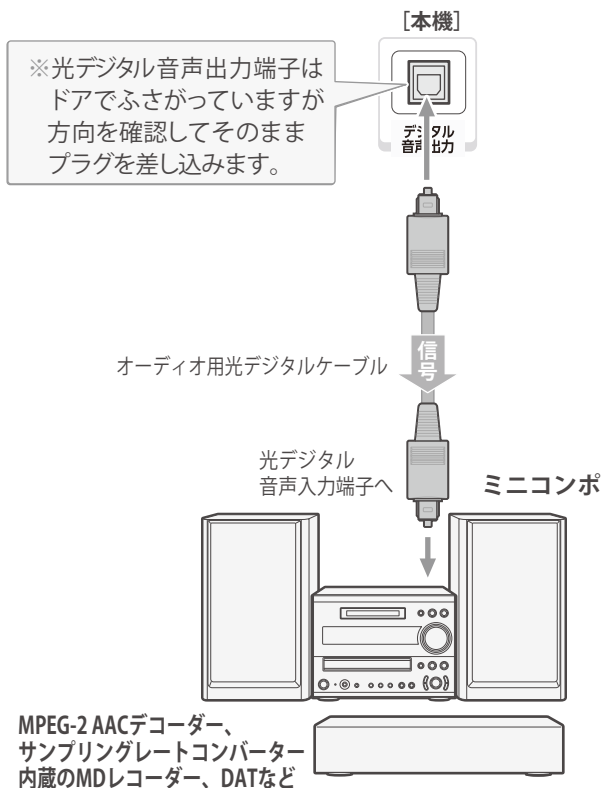

※ 光デジタル音声ケーブルのプラグには2種類の形状があります。接続する機器の端子形状に合ったケーブルをお買い求めください。
本機側に差し込むプラグの形状は、です。

HDMI 連動対応のオーディオ機器で聴くとき

- HDMI 連動対応のオーディオ機器を本機に HDMI ケーブルで接続すれば、本機のリモコンでオーディオ機器の音量を調節するなどの操作ができます。(P.78)
- オーディオ機器の HDMI 入力端子に HDMI 連動対応機器を接続することができます。
- オーディオ機器が対応しているデジタル音声入力に従って、「デジタル音声出力」(P.110) の設定をします。また、必要に応じて「HDMI 連動設定」(P.79) をしてください。
- ARC 対応のオーディオ機器は HDMI 入力 1(ARC) 端子に接続してください。

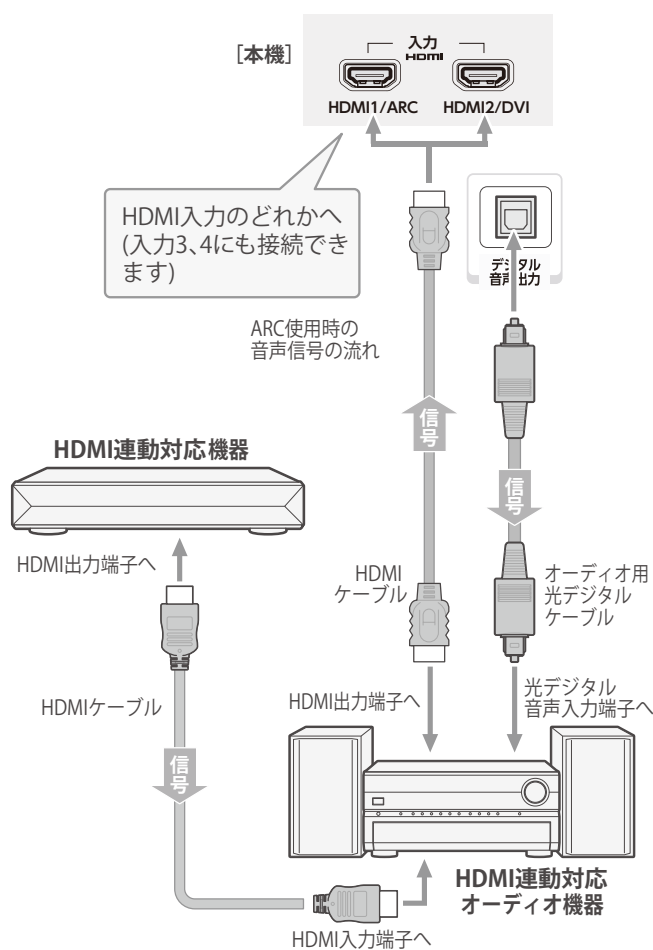

※ ARC対応のオーディオ機器を、ARC対応のHDMIケーブルでHDMI入力1 (ARC) 端子に接続する場合は、光デジタルケーブルの接続は不要です。

お知らせ.....

- 光デジタル音声出力端子と HDMI 入力 1(ARC) 端子から出力される信号は、音声メニューおよび音声調整の効果を得られません。(ドルビー DRC の効果は、「PCM」や「オート」を選択していてリニア PCM 信号で出力される場合にだけ得られます)
- サンプリングレートコンバーターを内蔵していない MD レコーダーには、デジタル信号での録音はできません。
- MPEG-2 AAC 音声の場合には、主音声・副音声の切換は本機では行われません。MPEG-2 AAC デコーダー側で切り換えてください。
- HDMI 入力の選択時に、入力信号が著作権保護されている場合は、光デジタル音声出力端子または HDMI 入力 1(ARC) 端子から出力される信号を他の機器に録音することはできません。
- 本機の HDMI 入力端子が対応している入力信号および HDMI ケーブルについては (P.70) をご覧ください。

外部入力機能の設定

- 外部入力のさまざまな機能を設定することができます。必要に応じて設定してください。
- 「HDMI モードを変更する」の操作をするときは、事前に **入力切換** を押して、HDMI モードを変更する外部入力を選びます。

- 1、設定 を押し、▲・▼と 決定 で「その他の設定」⇒「外部入力・HDMI 連動設定」⇒「外部入力設定」の順に進む
- 2、以降の手順で設定する



入力切換時に画面に表示される機器名を設定する

- 入力切換をしたときに表示される機器の名称（ブルーレイ、DVD など）を変更することができます。

- ① ▲・▼で「外部入力表示設定」を選び、決定 を押す
- ② 設定する外部入力を▲・▼で選び、決定 を押す

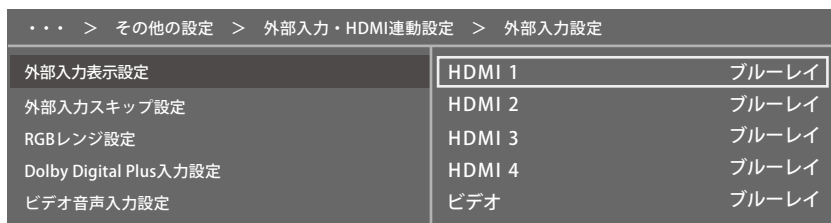

- ③ 表示させる機器名を▲・▼・◀・▶で選び、決定 を押す



- 設定が切り換わるまで、しばらくお待ちください。

使用しない外部入力をスキップする

● 入力切替をするときに、使っていない入力を自動でスキップする（飛び越す）ことができます。

- ① ▲・▼で「外部入力スキップ設定」を選び、決定 を押す
- ② 設定する外部入力を▲・▼で選び、決定 を押す

・・・ > その他の設定 > 外部入力・HDMI連動設定 > 外部入力設定		
外部入力表示設定	HDMI 1	しない
外部入力スキップ設定	HDMI 2	しない
RGBレンジ設定	HDMI 3	しない
Dolby Digital Plus入力設定	HDMI 4	しない
ビデオ音声入力設定	ビデオ	しない

- ③ ▲・▼で「する」または「しない」を選び、決定 を押す
 - ・ する・・・・・・・・・・入力切替時に入力をスキップします。
 - ・ しない・・・・・・・・・・入力切替時にスキップしません。
- 設定が切り換わるまで、しばらくお待ちください。

HDMIモードを変更する

- 高速信号モードは4K映像に対応している機器からの4K映像をより高精細に再生するときに選びます。
- 通常モードは「高速信号モード」で映像や音声が入力されず出力されないときに選びます。
- 互換性優先モードは「通常モード」で映像や音声が入力されず出力されないときに選びます。
※ 4K映像信号には対応していません。

- ① ▲・▼で「HDMI*モード選択」を選び、決定 を押す
 - 「*」は現在選ばれているHDMI入力の番号になります。
HDMI入力1を選んでいるときは、「HDMI 1 モード選択」と表示されます。
- ② ▲・▼を押してモードを選び、決定 を押す
 - 設定が切り換わるまで、しばらくお待ちください。

Dolby Digital Plusの入力を設定する

● HDMI端子の入力設定をDolby Digital Plus対応サウンドシステムと連動するかどうかを設定します。

- ① ▲・▼で「Dolby Digital Plus入力設定」を選び、決定 を押す
 - ② ▲・▼で以下の設定から選び、決定 を押す
 - ・ 連動する : 本機のHDMI入力1(ARC)端子に接続したDolby Digital Plus対応サウンドシステムに適した音声設定を、本機のHDMI端子に設定します。
 - ・ 連動しない : 本機のDolby Digital Plus設定で動作します。
- 設定が切り換わるまで、しばらくお待ちください。

外部入力 of 機能設定する (つづき)

HDMI入力のRGBレンジを設定する

● 本機がRGBレンジを自動識別できない機器を接続している場合は、機器の仕様に合わせて設定します。

- ① ▲・▼で「RGBレンジ設定」を選び、決定を押す
- ② 設定するHDMI入力を▲・▼で選び、決定を押す



- ③ ▲・▼で以下の設定から選び、決定を押す
 - ・ オート 自動切替になります。
 - ・ フルレンジ RGBレンジが0～255の機器の場合に選びます。
 - ・ リミテッドレンジ RGBレンジが16～235の機器の場合に選びます。
- 設定が切り換わるまで、しばらくお待ちください。

ビデオ入力の音声入力を設定する

● HDMI入力2端子に接続した機器からの音声を本機から出したいときに、ビデオ入力の音声入力端子をHDMI入力2のアナログ音声入力端子として使用するように設定できます。

- ① ▲・▼で「ビデオ音声入力設定」を選び、決定を押す
- ② ▲・▼で以下の設定から選び、決定を押す

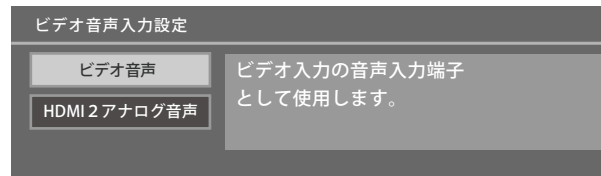

- ・ ビデオ音声 ビデオ入力の音声入力端子として使用します。（お買い上げ時の設定）
- ・ HDMI2アナログ音声 HDMI入力2のアナログ音声入力端子として使用します。
- 設定が切り換わるまで、しばらくお待ちください。

USB機器を接続する

● USB機器に保存されている動画や写真を本機で見ることができます。（P.87）～（P.94）

※ 暗号化や指紋認証などのセキュリティ機能を有効にした機器や記録メディアなどは、本機では使用できません。



ご注意.....

- 前ページの USB 機器は、上段側の USB 端子に接続してください。下段側の USB（通常録画）端子には接続しないでください。
- USB 機器を取りはずすときは、動画や写真の再生を終了させてください。再生中に機器を取りはずしたり、電源を切ったりすると、機器や記録メディアに記録されているデータが破壊されるおそれがあります。
- それぞれの機器の動作や取り扱いなどについては、機器の取扱説明書をよくお読みください。

機器の接続時に操作メニューが表示されるようにする

- 「オートメディアプレーヤー」を「オン」に設定しておくで、放送番組や外部入力の見聴時にUSBメモリーなどを挿入したときに、操作の選択メニューが表示されます。（お買い上げ時は「オン」に設定されています）

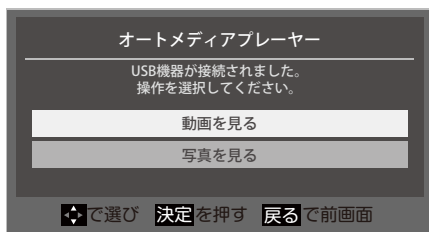

※ USBメモリーなどを挿入した状態で本機の電源を入れた場合や、放送番組・外部入力の視聴以外の操作をしているときにUSBメモリーなどを挿入した場合には、オートメディアプレーヤーの画面は表示されません。

1、設定 を押し、▲・▼と決定で「録画・再生設定」⇒「オートメディアプレーヤー」の順に進む

設定		
映像設定	録画・再生設定	
音声設定	USB ハードディスク設定 >	
録画・再生設定	録画設定 >	
	再生設定 >	
通信設定	オートメディアプレーヤー オン	オン
放送受信設定	通信設定	オフ
初期設定	詳細設定 >	
その他の設定	接続テスト >	
	ネットワーク情報 >	
	放送受信設定	
	地上デジタル設定 >	

2、▲・▼で「オン」または「オフ」を選び、決定 を押す

- ・ オン・・・オートメディアプレーヤーの画面が表示されます。
- ・ オフ・・・オートメディアプレーヤーの画面は表示されません。

お知らせ.....

- すべての USB 機器の動作を保証するものではありません。
- USB ハブを使って本機の USB 端子に接続した場合に認識できる USB ハブは二つで機器数は最大7台です。スロットを複数持つメモリーカードリーダーなどの場合は、1 スロットで1 台とみなされます。なお、USB ハブを使った場合は、正常に動作しないことがあります。

HDMI 連動について

HDMI連動機能でできること

- 本機は以下のHDMI連動機能に対応しています。

本機のリモコンで対応機器の操作をする

- 本機に接続したHDMI連動対応の録画機器や再生機器などの操作が本機のリモコンでできます。(P.83)

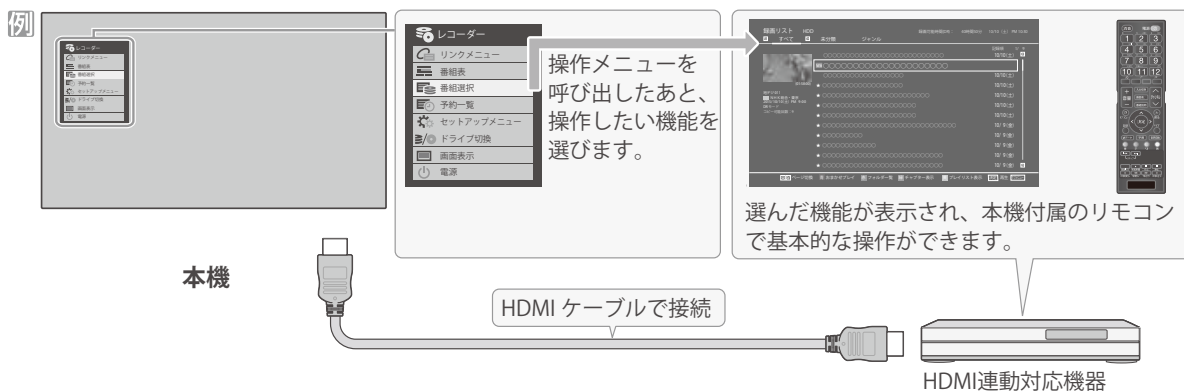

電源の入／切や入力切り換えの動作を連動させる

- ワンタッチプレイ・・・ HDMI連動対応機器を操作すると、機器に連動して本機の電源がはいり、操作した機器に合わせて入力が切り換わります。
- システムスタンバイ・・・ 本機の電源を「切」にすると、機器も連動して電源が「切」(待機)になります。

オーディオ機器と連携させる

- オーディオ機器に接続されているスピーカーで聴いたり、本機のリモコンでオーディオ機器の音量を調節したりすることができます。また、ジャンルに適した音声オーディオ機器のスピーカーから出るようにすることもできます。(P.86)

例 音声に対応機器のスピーカーで聴く

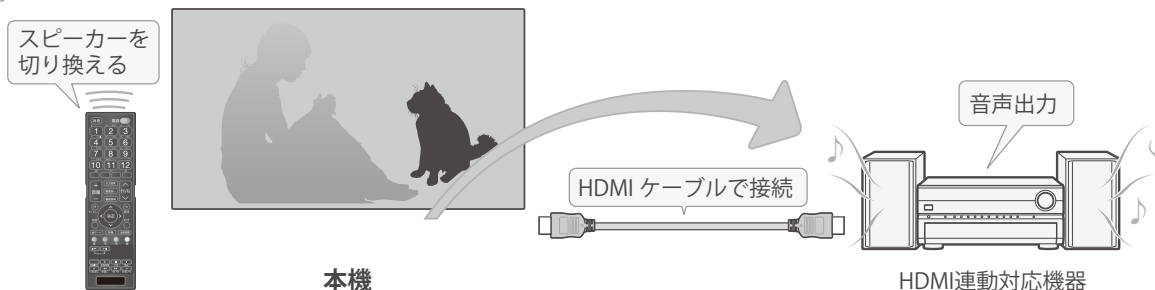

準備をする

機器	接続・設定	機器についてのお知らせ
HDMI連動対応の映像機器やオーディオ機器	映像機器の接続：(P.69) オーディオの接続：(P.73)	● HDMI連動機能を使うには、接続機器それぞれの設定が必要です。詳しくは、接続する機器の取扱説明書をご覧ください。

HDMI連動機能について

- 本機のHDMI連動機能では、HDMIで規格化されているHDMI CEC（Consumer Electronics Control）を利用し、機器間で連動した操作をすることができます。
 - 接続したHDMI連動機器によっては、一部またはすべての連動操作ができないことがあります。
 - HDMI連動機器の接続、設定を変更した場合は以下の操作をしてください。
 - ・ 接続機器の電源をすべて「入」の状態にして、本機の電源を入れ直してください。
 - ・ すべての接続機器の動作を確認してください。
- ※ 機器に割り振られる番号は接続形態によって変化することがあります。

オーディオ機器について

- オーディオ機器の入力状態によっては、本機から音声がでないことがあります。
- オーディオ機器の連動操作中にオーディオ機器側の入力を切り換えると、実際の映像と画面右上の接続機器表示が一致しないことがあります。

お知らせ・・

■ システムスタンバイについて

- 省エネ設定の機能などで本機が待機状態になったときも同時に機器側の電源が「待機」になります。
- 接続機器側がシステムスタンバイに対応している場合、接続機器の電源を「待機」にしたときに本機の電源も「待機」にすることができます。

接続機器を使う

本機のリモコンでHDMI連動機器を操作するための設定をする

- 本機のリモコンでHDMI連動機器の基本操作をしたり、各種の連動動作をさせたりするための設定をします。
- お買い上げ時、本機はHDMI連動機能を使用するように設定されています。接続機器側の設定も必要です。ご確認ください。

- 1、設定 を押し、▲・▼と 決定 で「その他の設定」⇒「外部入力・HDMI連動設定」⇒「HDMI連動設定」の順に進む
- 2、設定する項目を▲・▼で選び、決定 を押す

設定 > その他の設定 > 外部入力・HDMI連動設定 > 外部入力設定		
外部入力設定	HDMI 連動機能	使用する
HDMI連動設定	リモコン動作モード	テレビ優先
	連動機器→テレビ入力切換	連動する
	連動機器→テレビ電源	連動する
	テレビ→連動機器電源オフ	連動する
	サウンドシステム連動	使用する
	電源オン時優先スピーカー	テレビスピーカー

- 3、設定したい項目を▲・▼で選び、決定 を押す

本機のリモコンでHDMI連動機器を操作するための設定をする

HDMI連動機能

- 本機のリモコンでのHDMI連動機器操作、および以下の各種連動機能を使用するかどうかを設定します。

リモコン動作モード

- 本機からの操作に対応したHDMI連動対応機器を接続している場合、「連動機器優先」に設定すると、本機のリモコンで操作できる機能が増えます。

連動機器→テレビ入力切換

- 連動機器の再生操作をしたときに、本機が自動的に入力切換をして、その機器を選択する機能です。本機の電源が「入」の場合に動作します。

連動機器→テレビ電源

- 連動機器の再生操作をしたときに本機の電源が「入」になり、連動機器の電源を「待機」にしたときに本機の電源も「待機」になる機能です。

※この機能と、「連動機器→テレビ入力切換」を「連動する」に設定しておく、と、本機の電源が「入」になったあとに自動的に入力が切り換わります。

※本体の電源ボタンで電源を切った場合、この機能は働きません。リモコンの電源ボタンで電源を「待機」にしてください。

テレビ→連動機器電源オフ

- 本機の電源を「待機」にしたときに、連動機器の電源も「待機」になる機能です。（録画中の機器など、動作状態によっては「待機」にならないことがあります）

※ 本機の「省エネ設定」（P.34）や「オフタイマー」（P.37）とも連動します。

サウンドシステム連動

- テレビのリモコンでサウンドシステムのスピーカーを操作する機能の設定をします。
 - ・ 使用する・・・サウンドシステムのスピーカー切換と音量調整を使用するときに選びます。
 - ・ 使用しない・・・サウンドシステムのスピーカー切換や音量調整を使用しないときに選びます。

電源オン時優先スピーカー

- 本機の電源オン時に優先するスピーカーを選択します。

※ 「サウンドシステム連動」を「使用する」に設定した場合に設定できます。

- ・ テレビスピーカー

本機のスピーカーから音声が出ます。

- ・ サウンドシステム

オーディオ機器の電源が「入」のときは、オーディオ機器のスピーカーから音声が出ます。

- サブメニューでスピーカーを一時的に切り換えることもできます。（P.86）

※ サブメニューでスピーカーを切換した場合は本機の電源操作で、優先スピーカー設定で選択した状態に戻ります。

お知らせ.....

- 連動機器の機能、設定によっては、HDMI 連動設定をしても、一部もしくはすべての機能が働かないことがあります。
- 本機が認識できる HDMI 連動対応機器の台数は、HDMI CEC 規格に従って、オーディオ機器：1 台、録画機器（レコーダーなど）：3 台、再生機器（プレーヤー / PC など）：3 台までに制限されます。
- 「連動機器→テレビ入力切替」を「連動する」に設定しても、本機の状態によっては自動的に入力が切り換わらないことがあります。

外部入力画面に切り替える

- 本機の外部入力端子（HDMI入力1～4、ビデオ入力）に接続したビデオやDVD・ブルーレイディスクプレーヤー/レコーダーなどの再生番組を見たり、ゲーム機を接続して楽しんだりする場合は、以下の操作をします。
- 機器の接続や設定については、「外部機器を接続する」（P.69～P.73）をご覧ください。



- 1、使用する機器の電源を入れる
- 2、入力切替 を押す
 - 入力切替 を押すと次の入力を選択された状態で画面左上に入力一覧画面が表示され、少し待つとその入力に切り換わります。希望の入力を選ぶには、入力が切り換わる前に次の手順3の操作をします。
 - ・「外部入力スキップ設定」(P.75) が「する」になっている入力は薄く
なって表示され、入力切替時にスキップされるようになっています。
- 3、入力切替 を繰り返し押すか、または▲・▼を押して入力を選ぶ
 - 入力切替 を押すたびに以下のように切り換わります。

→ 放送 → HDMI1 → HDMI2 → HDMI3 → HDMI4 → ビデオ

- ・ ▲・▼では順方向・逆方向の選択ができます。
- 少し待つと選択した入力に切り換わります。

HDMI連動機器を選ぶとき

- ・ HDMI連動対応のオーディオ機器などにHDMI連動機器が接続されている場合は、機器の一覧が表示されます。使用する機器を以下の手順で選択できます。

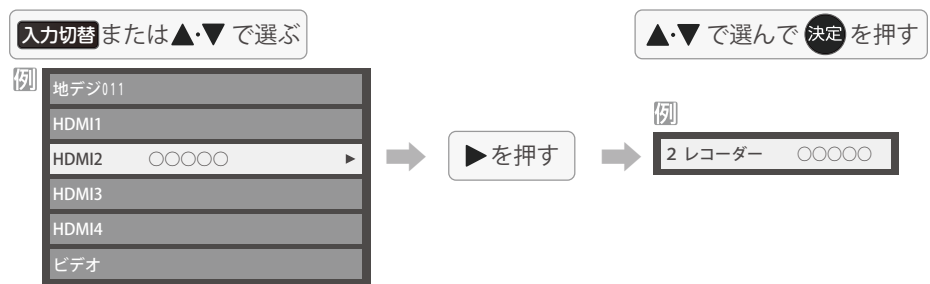

お知らせ.....

- 入力切替時に画面に表示される「ブルーレイ」などの機器名を変えることができます。「外部入力表示設定」(P.74) をご覧ください。

4、選択した機器を操作する

- 機器のリモコンで再生などの操作をしてください。
- ゲーム機を接続した入力では、「映像メニュー」(P.102)を「ゲーム」にしてください。ゲームのレスポンスを重視した、ゲームに適した画質設定になります。

HDMI連動機器を選んだとき

- 機器操作メニューや本機のリモコンで機器を操作することができます。
- 機器操作メニューの使い方
 - ① サブメニュー を押す
 - ② ▲・▼で「機器操作」を選び、決定 を押す
 - 機器操作メニューが表示されます。機器操作メニューや本機のリモコンで操作できる機能については、「本機のリモコンで対応機器を操作する」(以下)をご覧ください。

接続機器を使う

本機のリモコンで対応機器を操作する

機器を操作する

- 入力切換 の操作でHDMI連動対応機器が接続された入力(HDMI1~4)を選んだあと、「サブメニュー」の「機器操作」を選ぶと、操作メニューが表示されます。
- 機器によって表示される操作メニューの内容や、操作できる内容が異なります。
- 「その他の操作」を選ぶとサブメニューが表示されます。
- ① サブメニュー を押し、▲・▼で「機器操作」を選んで決定 を押す

例

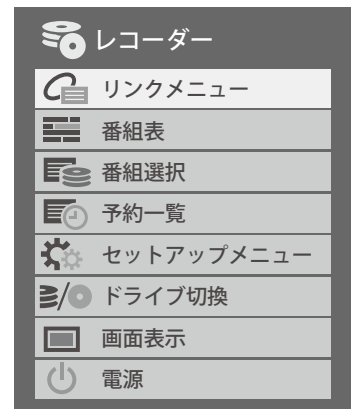

- 本機のリモコンで、HDMI連動対応のレコーダーやプレーヤーなどの基本操作をすることができます。
 - 本機のリモコンでできる操作については、(P.85)をご覧ください。
 - 機器を操作すると機器操作メニューが消えます。(機器操作メニューを再表示させるには、手順①の操作をします)
 - HDMI CEC対応の機器を操作します。
 - すべての製品でメニューに表示されたすべての機能の操作ができることを保証するものではありません。

本機のリモコンで対応機器を操作する (つづき)

HDMI連動機器に接続された機器

● HDMI連動対応のオーディオ機器などにHDMI連動機器が接続されている場合は、以下のようになります。

例

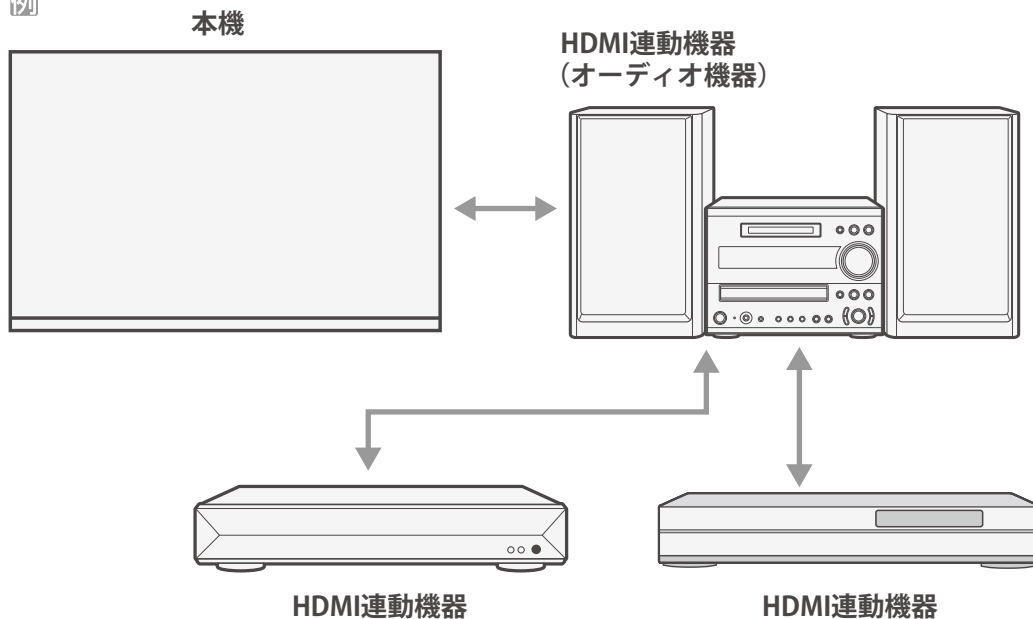

レコーダーなどを選択したとき

● 「サウンドシステムを操作」を選ぶと、オーディオ機器の機器操作メニューが表示されます。

例

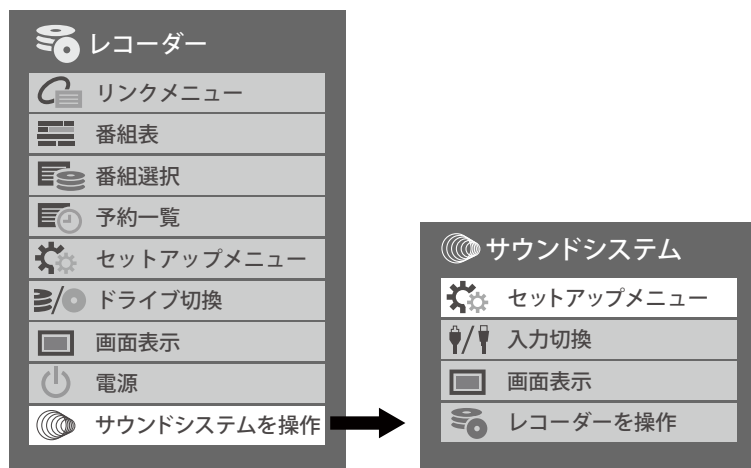

本機のリモコンでできるおもな操作

- HDMI連動機器を接続した場合、本機のリモコンで以下の操作をすることができます。
- ※ 以下は代表的な動作です。操作する機器によっては、動作が異なる場合があります。



本機のリモコンボタン	動作の内容
 早見早聞	番組を再生します。
 静止	再生中に押すと一時停止になります。 もう一度押すと、再生が再開されます。
 停止	録画や再生を停止します。
 スキップ	一つ先に進んで頭出し再生をします。
 スキップ	前に戻って頭出し再生をします。
 早送り	再生中に押すと早送り再生になります。
 早戻し	再生中に押すと早戻し再生になります。
 30秒送り	再生中に押すと少し先に進んで再生します。
 10秒戻し	再生中に押すと少し戻って再生します。
△・▽・◀・▶	メニューなどで項目を選択します。
	選択した内容を決定したり、選択した操作を実行したりします。
	一つ前の操作に戻ります。
	操作を終了します。
青 赤 緑 黄	各機器でカラーボタンに割り当てられた機能を操作します。
	オーディオ機器の音量を調節します。
	オーディオ機器の音を消します。

オーディオ機器(サウンドシステム)で聴く

オーディオ機器のスピーカーで聴く

- オーディオ機器に接続されているスピーカーで聴いたり、本機のリモコンでオーディオ機器の音量を調節したりすることができます。
- 本機とオーディオ機器をHDMIケーブルおよび光デジタルケーブルで接続します。ARC対応のオーディオ機器は ARC対応のHDMIケーブルでHDMI入力1(ARC)端子に接続し、光デジタルケーブルの接続は不要です。(P.73)
- 光デジタルケーブルの代わりに音声用コードで接続することもできます。その場合は、「ヘッドホン／音声出力設定」で「外部スピーカー」を選び、「外部スピーカー出力設定」を「固定」に設定します。(P.111)
- HDMI連動に非対応のオーディオ機器の場合、本機のスピーカーから音声を出さないときは、以下の操作をするか、または本機の音量を最小に調節してください。

1、サブメニュー を押し、▲・▼で「スピーカー切替」を選んで 決定 を押す

2、▲・▼で「サウンドシステムスピーカー」または「外部スピーカー」を選び、 決定 を押す

- 以下の場合に「サウンドシステムスピーカー」が表示されます。
 - ・ 本機と音声連携が可能なオーディオ機器がHDMIケーブルで接続されていて、動作状態になっている。(オーディオ機器のスピーカーから音声が出るようになっている)
 - ・ 「HDMI連動設定」(P.79) が以下のように設定されている。
 - ・ HDMI連動機能 使用する
 - ・ サウンドシステム連動 使用する
- 本機のスピーカーで聴くときは、「テレビスピーカー」を選びます。

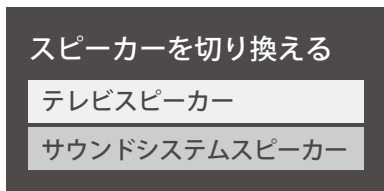

3、音量を調節する

- HDMI連動対応のオーディオ機器では、本機のリモコンで音量調節と消音の操作ができます。
- ※ HDMI連動非対応のオーディオ機器を音声用コードで接続している場合は、「ヘッドホン／音声出力設定」の「外部スピーカー出力設定」(P.111) に従った方法で音量を調節してください。
 - ・ 固定 オーディオ機器で音量を調節します。
 - ・ 可変 本機のリモコンで音量を調節します。

お知らせ

- 音量表示が「サウンドシステム音量」に変わっているとき、本機のスピーカーおよび「通常モード」(P.35) 選択時はヘッドホン端子から音声は出ません。

動画を再生する

- USB機器に保存されている動画を本機で視聴できます。
- 機器の接続や設定などの準備については、「USB機器を接続する」(P.76)をご覧ください。
- 本機で再生できる動画のフォーマットについては、(P.126)をご覧ください。

ご注意.....

- 再生中は、機器を取りはずしたり、機器や本機の電源を切ったりしないでください。記録されているコンテンツが損なわれることがあります。

動画再生の操作

- オートメディアプレーヤーの画面が表示された場合は、▲・▼で「動画を見る」を選んで、決定を押し、手順3から操作します。

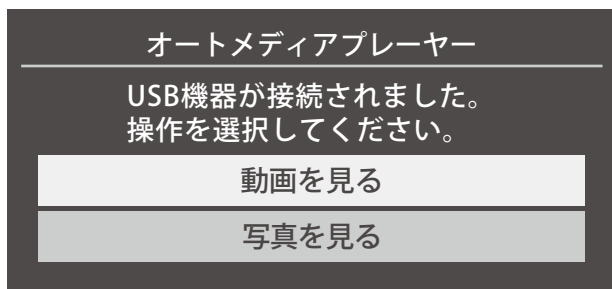

- 1、サブメニューの「メディアプレーヤー」から「動画」に進む
 - 2、再生機器を、▲・▼・◀・▶で選び、決定を押し、青を押すと再生機器を検索することができます。
 - 3、フォルダを▲・▼で選び、決定を押し
- 機器によっては、この操作はありません。

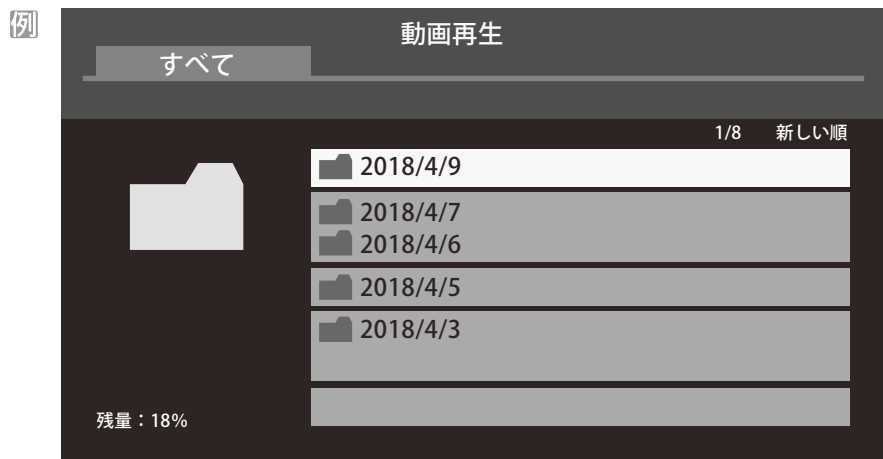

動画を再生する

4、動画を▲・▼で選び、決定を押す



- 再生中に次ページのリモコン操作ができます。

表示モード切換ができるとき

- 操作ガイドに「緑 表示モード切換」が表示される場合、動画再生リストの表示モード切換ができます。
- 「タブ表示」にしたときのリスト画面の表示切換操作については、(P.57)の手順2をご覧ください。

5、動画再生を終了するには、■ (停止)または 終了 を押す

- 放送画面などに戻ります。











お知らせ.....

- レジュームポイントが記憶されている場合は、続きから再生されます。
- USB 機器で記録されたコンテンツの場合、手順4で選択した動画を先頭にリスト内の動画の連続再生になります。

動画再生時に出来るリモコン操作

- 機器によっては再生と停止しかできないなど、機能が制限されることがあります。
- ワンタッチスキップとワンタッチリプレイの時間は、「ワンタッチスキップ／ワンタッチリプレイの時間を変更する」(P.60)で変更することができます。



本機のリモコンボタン	動作の内容
 早見早聞	動画の再生を開始します。 ・再生中に繰り返し押すと、1.5倍の速さの音声付早送り再生「早見早聞」と通常の再生が交互に切り替わります。 ※動画や機器によっては、「早見早聞」が正しく動作しない事があります。
 静止	再生中に押すと一時停止になります。 ・一時停止中にもう一度押すと、再生が再開されます。
 停止	動画の再生を終了し、放送画面などに戻ります。
 早送り	早送り再生をします。(押すたびに速さが変わります) ・一時停止中に1秒ほど押し続けるとスロー再生、または連続コマ送りになります。スロー再生または連続コマ送り中に押すと、押すたびに速さが変わります(2段階または3段階(再生する動画のある機器によって異なります))。
 早戻し	早戻し再生をします。(押すたびに速さが変わります) ・一時停止中に1秒ほど押し続けると連続コマ戻し再生になります。
	再生中に押すと、20ポイントに分割された動画の前後のポイントへスキップします。 ・再生時間が短い動画では動作しないことがあります。
 30秒送り	再生中に押すと、30秒ほど先に進んで再生します。(ワンタッチスキップ)
 10秒戻し	再生中に押すと、10秒ほど戻って再生します。(ワンタッチリプレイ)
 スキップ ※	次の動画の先頭にスキップして再生します。
 スキップ ※	現在の動画の先頭にスキップして再生します。再生してから約4秒以内に押した場合は、一つ前の動画の先頭にスキップします。
 録画リスト	再生中に押すと、動画再生のリスト画面が表示されます。

※機器によってはスキップの対象がチャプターになります。

動画を再生する (つづき)

動画の再生方法を設定する

- 動画を繰り返して再生することができます。
 - 設定した状態は本機に記憶されます。
- 1、動画再生リストの表示中に **サブメニュー** を押す
 - 2、▲・▼で「再生設定」を選び、**決定** を押す
 - 3、▲・▼で以下から選び、**決定** を押す
 - ・ 1コンテンツリピート …… 選択した一つの動画の再生を繰り返します。(🔄)
 - ・ リピート …… フォルダ内にあるすべての動画の連続再生を繰り返します。(🔄)
 - ・ オフ …… 繰り返し再生をしません。

時間を指定して再生する (タイムサーチ)

- 1、再生中に **サブメニュー** を押し、▲・▼で「サーチ」を選んで、**決定** を押す
- 画面右上に **サーチ** が表示されます。
- 2、1～10 (0)で時間を指定する
- 例 冒頭から1時間25分5秒後の位置を指定するとき
10 (0) 1 2 5 10 (0) 5 の順に押します。

動画を並べ替える

- 機器によっては並べ替えができないことがあります。
- 1、動画再生リストの表示中に **サブメニュー** を押す
 - 2、▲・▼で「並べ替え」を選び、**決定** を押す
 - 3、▲・▼で「新しい順」または「古い順」を選び、**決定** を押す

機器を選びなおす

- 使用する機器を選び直すときは、**青** を押します。
- 動画再生リストのときに **サブメニュー** を押し、▲・▼で「機器の情報」を選んで **決定** を押すと、機器の情報を確認できます。

動画再生リストの操作ガイドについて

- 機器によっては、以下の操作ガイドが表示される場合があります。
- ・ 赤 削除
「不要な録画番組を消す」(P.64)を参考にしてください。
- ・ 緑 表示モード切換
「表示モード切換ができるとき」(P.88)をご覧ください。

写真を再生する

- USB機器に保存されている写真を本機で見ることができます。
- 機器の接続や設定などの準備については、「USB機器を接続する」(P.76)をご覧ください。
- 本機で再生できる写真のフォーマットについては、(P.126)をご覧ください。

ご注意.....

- 再生中は、機器を取りはずしたり、機器や本機の電源を切ったりしないでください。記録されているデータが損なわれることがあります。

写真再生の操作

- オートメディアプレーヤーの画面が表示された場合は、▲・▼で「写真を見る」を選んで、決定 を押し、手順3から操作します。

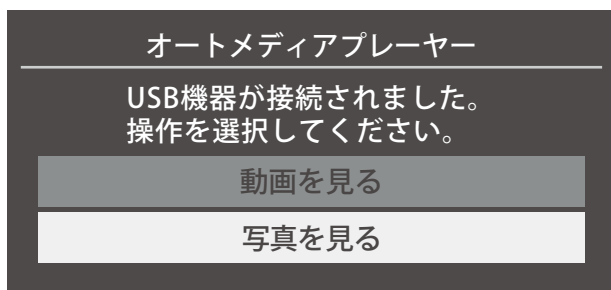

- 「オートメディアプレーヤー」または、以下の手順1または手順2の操作で写真再生が起動すると、「写真再生」のマルチ表示画面になります。（図はUSB機器の例です）



- 1、サブメニューの「メディアプレーヤー」から「写真」に進む
- 2、再生機器を▲・▼・◀・▶で選び決定を押す
 - 対象機器が1台の場合、この操作はありません。

写真を再生する (つづき)

3、以下の操作で写真を見る

1枚だけ拡大して表示する (シングル再生)

① マルチ表示画面から、見たい写真を ▲・▼・◀・▶ で選び、決定 を押す

● 選択した写真が画面に拡大表示されます。



● ◀・▶ で前の写真や次の写真に切り換えられます。

● ◀◀・≫≫ で最初の写真や最後の写真にスキップできます。

● マルチ表示画面に戻るときは 戻る を押します。

自動的に順番に表示する (スライドショー再生)

① 緑 を押す

● 選択中の写真から順番に表示されます。



● スライドショー再生を一時停止するには 青 を押します。もう一度 青 を押すと再開されます。

● ◀・▶ で前の写真や次の写真に切り換えられます。

● ◀◀・≫≫ で最初の写真や最後の写真にスキップできます。

● シングル再生に戻るときは 緑 を押します。

● マルチ表示に戻るときは 黄 を押します。

お知らせ.....

● フォルダ内にサイズの大きい写真が複数ある場合、写真リストが表示されないことがあります。

● 写真の表示中は、音声出力 (固定 / 可変) 端子から音声信号は出力されません。

● パソコンのアプリケーションソフトを使って加工や編集をした写真は、再生できないことがあります。

写真を回転させるには

- マルチ表示画面、シングル再生画面、スライドショー再生画面で写真を回転させることができます。
- ① 赤 を押す
- 赤 を押すたびに時計回りに90度ずつ回転させることができます。
- 回転させた状態は記憶されません。

写真だけを表示するには

- シングル再生画面、スライドショー再生画面に表示された写真以外の情報を消すことができます。
- ① 画面表示 を押す
- もう一度 画面表示 を押すと情報が表示されます。

4、写真再生を終了するとき、終了 を押す

マルチ表示画面の表示モードを切り換える

- USB機器の場合に、マルチ表示画面の表示モードを切り換えることができます。
- 1、マルチ表示画面のときに 黄色 を押す
- 黄色 を押すごとに以下の「シームレス」または「フォルダ別」に切り換わります。
- ・シームレス… 第1階層にあるDCIMフォルダや、その中にある第6階層までのフォルダに保存されている写真だけが最大1000枚まで表示されます。(シームレス表示で写真が見つからないときは、自動でフォルダ別表示に切り換えます)
- ・フォルダ別… 写真および、同じ階層にあるフォルダが合計1000まで表示されます。



フォルダを開くには

- 「フォルダ別」の表示モードのときに、フォルダを開くには以下の操作をします。
- ① ▲・▼・◀・▶ でフォルダを選び、決定 を押す
- 上の階層に戻るときは 戻る を押します。

再生を繰り返す

- シングル再生やスライドショー再生を繰り返すことができます。
- 設定した状態は本機に記憶されます。
- 1、マルチ表示、シングル再生、またはスライドショー再生画面のときに サブメニュー を押す
- 2、▲・▼で「再生設定」を選び、決定 を押す
- 3、▲・▼で以下から選び、決定 を押す

写真を再生する (つづき)

- ・ リピート フォルダ内にあるすべての写真の連続再生を繰り返します。
- ・ シャッフル フォルダ内のすべての写真をランダム順に再生します。
- ・ シャッフルリピート ランダム再生を繰り返します。
- ・ オフ 繰り返し再生やランダム順再生をしません。



● 設定に従って、再生画面やマルチ画面にアイコンが表示されます。

スライドショーの表示間隔の設定をする

- 写真の表示が完了してから次の写真の表示が始まるまでの時間を設定します。表示が完了するまでの時間は、写真のファイルサイズによって異なります。
- 設定した状態は本機に記憶されます。
 - 1、マルチ表示画面またはスライドショー再生画面のときに **サブメニュー** を押す
 - 2、▲・▼で「間隔設定」を選び、**決定** を押す
 - 3、▲・▼で以下から選び、**決定** を押す
- 以下は目安です。
 - ・ 速い 表示が完了してから約5秒後
 - ・ 標準 表示が完了してから約10秒後
 - ・ 遅い 表示が完了してから約30秒後

マルチ表示画面の写真の並べ順を変える

- 表示モードが「フォルダ別」のマルチ表示画面で、写真の並べ替えができます。
- 機器によっては、並べ替えができないことがあります。
 - 1、マルチ表示画面のときに **青** を押す
- **青** を押すたびに、「古い順」と「新しい順」が交互に切り換わります。
- フォルダが先に並び、次に写真が並びます。

機器を選び直す

- 使用する機器を選び直すには、マルチ表示のときに **サブメニュー** を押し、▲・▼で「機器選択」を選んで **決定** を押します。
- マルチ表示のときに **サブメニュー** を押し、▲・▼で「機器の情報」を選んで **決定** を押すと、機器の情報を確認できます。
 - ※ 機器によっては、「機器選択」の選択画面に表示されないことがあります。

インターネットを利用するための接続をする

- はじめてインターネットを利用する場合は、通信事業者やプロバイダー（インターネット接続業者）との契約が必要です。通信事業者または取り扱いの電気店などにご相談ください。
- 接続が終わったら、必要に応じて (P.97) の「インターネットを利用するための設定」をしてください。
- すでにパソコンでインターネットを利用している場合は、本機のLAN端子とルーターのLAN端子を市販のLANケーブルで接続するだけです。
- モデムとルーターが一体化されている場合もあります。それぞれの取扱説明書もよくお読みください。

本機をインターネットに接続したときにできること

できること	内容	記載ページ
データ放送の 双方向サービス	<ul style="list-style-type: none"> ● データ放送の双方向サービスを利用して、クイズ番組に参加したり、ショッピング番組で買物をしたりすることができます。 ※ 本機は電話回線を利用した双方向サービスには対応していません。 	(P.27)

接続のしかた

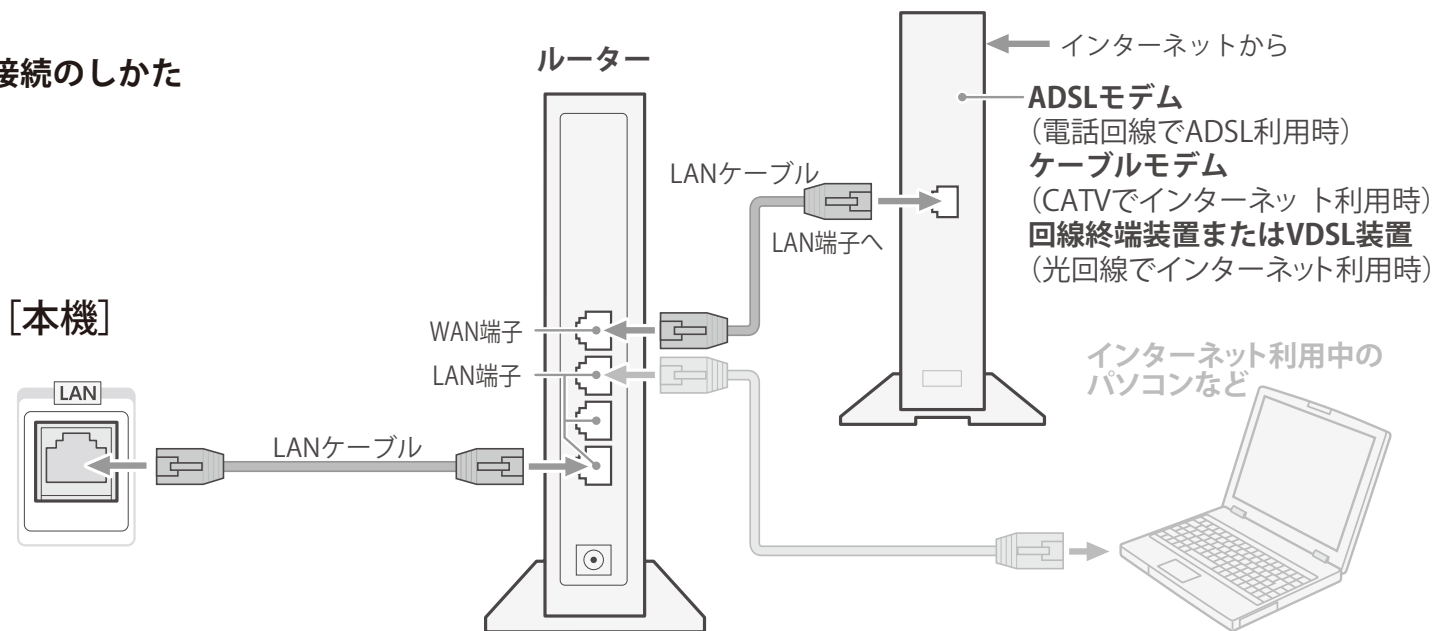

ご注意

- LAN ケーブルを抜き差しするときは、本機および接続機器などの電源を切り、電源プラグをコンセントから抜いてください。

インターネットを利用するための接続をする (つづき)

ご注意

- LAN ケーブルは、カテゴリ 5 (CAT5) と表示された規格以上のものをご使用ください。
- 本機の LAN 端子は、必ず電気通信端末機器の技術基準認定品ルーターなどに接続してください。
- 通信事業者およびプロバイダーとの契約費用および利用料金などは、ご自身でお支払いください。
- 以下の場合やご不明な点は、ご契約の回線事業者やケーブルテレビ会社、プロバイダーなどにお問い合わせください。
 - ・ ご契約によっては、本機やパソコンなどの機器を複数接続できないことがあります。
 - ・ 一部のインターネット接続サービスでは、本機を利用できないことがあります。
 - ・ プロバイダーによっては、ルーターの使用を禁止あるいは制限している場合があります。
 - ・ 回線の状況によっては、うまく通信できないことがあります。
 - ・ モデムについてご不明な点など。

お知らせ

- 本機では、ルーターやルーター内蔵モデムの設定はできません。これらの機器によっては、パソコンでの設定が必要な場合があります。
- 本機はダイヤルアップ通信や ISDN 回線などでインターネットを利用することはできません。
- この取扱説明書で図示していない機器が接続されている場合は、正常に通信できないことがあります。
- ルーターなどが正しく設定されていない回線に本機の LAN 端子を接続すると、本機が正常に動作しないことがあります。

インターネットを利用するための設定をする

- お買い上げ時の設定でインターネットが利用できない場合やネットワークの設定をやり直す場合に、必要に応じて設定します。

設定	
映像設定	通信設定
音声設置	詳細設定 >
録画・再生設定	接続テスト >
	ネットワーク情報 >
通信設定	放送受信設定
放送受信設定	地上デジタル設定 >
初期設定	BS・110度CSアンテナ設定 >
	BS/CS 4K設定 >
その他の設定	リモコンボタン設定 >
	データ放送設定 >
	ACAチップ情報 >

- 1、設定 を押し、▲・▼と決定で「通信設定」⇒「詳細設定」の順に進む
- 2、設定する項目を▲・▼で選んで、決定 を押す
- 3、以降の手順で設定する

アドレス設定(IPv4)

- インターネットに接続するために、本機に割り当てられる固有の番号を設定します。

IPアドレス

※「IPアドレス」を「手動設定」に設定した場合は、「DNSアドレス」は、自動的に「手動設定」に設定されます。

その場合は、DNSアドレスを手動で設定します。

- 1、IPアドレスを自動取得できる場合は、▲・▼で「自動取得」を選び、決定 を押す

アドレス設定(IPv4)

IPアドレス 自動取得

アドレス	192	168	1	20
サブネットマスク	255	255	255	0
デフォルトゲートウェイ	□	□	□	□

DNSアドレス 自動取得

プライマリアドレス	□	□	□	□
セカンダリアドレス	□	□	□	□

プロキシサーバー 使用しない

サーバー名	□
ポート番号	8080

設定完了

決定で選択 戻るで前画面

自動取得できないネットワーク環境の場合

- ① ▲・▼で「手動設定」を選び、決定 を押す
- ② ▲・▼で「アドレス」を選び、1～10 (0)で入力する
- ③ ▲・▼で「サブネットマスク」を選び、1～10 (0)で入力する
- ④ ▲・▼で「デフォルトゲートウェイ」を選び、1～10 (0)で入力する
 - ・ ②～④では0～255の範囲の数字（左端の欄は0以外）を四箇所の欄に入力します。
 - ・ 欄を移動するには、◀・▶を押します。

- 2、▲・▼で「設定完了」を選び、決定 を押す

インターネットを利用するための設定をする (つづき)

DNSアドレス

● ドメイン名をIPアドレスに置き換える機能を持ち、IPアドレスで特定されているDNSサーバーを設定します。

※「IPアドレス」を「手動設定」に設定した場合は、「DNSアドレス」は自動的に「手動設定」に設定され、「自動取得」にはできません。その場合は、DNSアドレスを手動で設定します。

1、DNSアドレスを自動取得できる場合は、▲・▼で「自動取得」を選び、決定を押す
自動取得できないネットワーク環境の場合

- ① ▲・▼で「手動設定」を選び、決定を押す
- ② ▲・▼で「プライマリアドレス」を選び、1～10 (0)で入力する
- ③ ▲・▼で「セカンダリアドレス」を選び、1～10 (0)で入力する
 - ・ ②と③では0～255の範囲の数字（左端の欄は0以外）を四箇所の欄に入力します。
 - ・ 欄を移動するには、◀・▶を押します。

2、▲・▼で「設定完了」を選び、決定を押す

プロキシサーバー

● インターネットとの接続時にプロキシ（代理）サーバーを経由する場合に設定します。

● ご契約のプロバイダーから指定がある場合にだけ設定します。

● ここでのプロキシ設定はHTTPに関するものです。

- ① ▲・▼で「使用する」を選び、決定を押す
- ② ▲・▼で「サーバー名」を選び、決定を押す
- ③ サーバー名を入力する
 - ・ 文字入力の方法は、(P.38)をご覧ください。
 - ・ 入力できる文字は半角英字／半角数字で、記号は半角の! "#%&()*+,-.:/;<=>@[¥]^_`?~/です。
- ④ ▲・▼で「ポート番号」を選び、1～10 (0)でポート番号を入力する
- ⑤ ▲・▼で「設定完了」を選び、決定を押す

IPv6接続

● IPv6アドレスを用いてネットワークに接続する場合に設定します。

※ ルーターのIPv6パススルー (IPv6ブリッジ) を有効にした場合は、外部からのアクセスが可能になり、セキュリティが低下します。同じルーターにつなぐパソコンは、正しくアクセス制限の設定をおこない、セキュリティ対策ソフトなどをお使いになることをお勧めします。

- ① ▲・▼で「利用する」または「利用しない」を選んで、決定を押す

アドレス設定(IPv6)

● IPv6で接続するとき、本機に割り当てられる固有の番号を設定します。

IPアドレス

※ 「IPアドレス」を「自動取得」に設定した場合は、IPv6ステートレスアドレス自動設定方式によりIPアドレスを取得した後、DHCPv6によりDNSアドレスを取得します。

※ 「IPアドレス」を「手動設定」に設定した場合は、「DNSアドレス」は、自動的に「手動設定」に設定されます。その場合は、DNSアドレスを手動で設定します。

- 1、IPアドレスを自動取得できる場合は、
▲・▼で「自動取得」を選び、決定 を押す

アドレス設定(IPv6)

IPアドレス

アドレス

サブネットマスク

デフォルトゲートウェイ

DNSアドレス

プライマリアドレス

セカンダリアドレス

決定を押す

自動取得できないネットワーク環境の場合

- ① ▲・▼で「手動設定」を選び、決定 を押す
- ② ▲・▼で「アドレス」を選び、1～10 (0)、11 (a～c)、12 (d～f)で入力する
- ③ ▲・▼で「デフォルトゲートウェイ」を選び、1～10 (0)、11 (a～c)、12 (d～f)で入力する
- ④ ▲・▼で「プレフィックス長」を選び、1～10 (0)で入力する
 - ・ ②、③では0～9、a～fの英数字（左端の欄は0以外）を八箇所の欄に入力します。
 - ・ ④では1～127の範囲の数字を入力します。
 - ・ 欄を移動するには、◀・▶を押します。

- 2、▲・▼で「設定完了」を選び、決定 を押す

DNSアドレス

※「IPアドレス」を「手動設定」に設定した場合は、「DNSアドレス」は自動的に「手動設定」に設定され、「自動取得」にはできません。その場合は、DNSアドレスを手動で設定します。

- 1、DNSアドレスを自動取得できる場合は、▲・▼で「自動取得」を選び、決定 を押す

自動取得できないネットワーク環境の場合

- ① ▲・▼で「手動設定」を選び、決定 を押す
- ② ▲・▼で「プライマリアドレス」を選び、1～10 (0)、11 (a～c)、12 (d～f)で入力する
- ③ ▲・▼で「セカンダリアドレス」を選び、1～10 (0)、11 (a～c)、12 (d～f)で入力する
 - ・ ②と③では0～9、a～fの英数字（左端の欄は0以外）を八箇所の欄に入力します。
 - ・ 欄を移動するには、◀・▶を押します。

- 2、▲・▼で「設定完了」を選び、決定 を押す

ネットワーク情報

- 1、設定 を押し、▲・▼で「通信設定」⇒「ネットワーク情報」を選び、決定 を押す

- 現在利用しているネットワーク情報が表示されます。
- ネットワーク接続の設定によっては、表示されない項目もあります。

接続テスト

- 1、設定 を押し、▲・▼で「通信設定」⇒「接続テスト」を選び、決定 を押す

インターネットを利用するための設定をする (つづき)

- 「ネットワーク設定」が正しいかテストします。テストが終わると「接続テスト結果」画面が表示されます。「インターネットに接続できました。」と表示された場合は、「終了」を押します。
- 正しく接続できなかった場合は、「再テスト」を選んで決定を押します。再度接続テストを行い、接続テスト結果画面が表示されます。再テストを行っても接続できない場合は、通信設定(P.97)の「詳細設定」を選んで決定を押し、設定をやり直してください。

ネットワーク設定の接続テスト結果について

- 接続テストの結果、正しく通信できなかった場合は、以下を確認します。
 - 1、LAN端子の接続状態と「ネットワーク設定」を確認する
 - ・ 正しく接続・設定されているかご確認ください。設定内容については、ルーターの設定内容に関係することがありますのでご注意ください。(ルーターの設定については、ルーターの取扱説明書をご覧ください)
 - 2、ネットワーク環境の接続確認
 - ・ 以下の手順で本機と同一ネットワーク上に接続されたパソコンからインターネットに接続できるか確認します。
 - ① パソコンのインターネット・ブラウザ (Internet Explorer など) を起動する
 - ② URL欄に「www.nhk.or.jp/」を入力し、ページが表示されることを確認する
 - ・ ページが正しく表示されない場合は、接続されているパソコンやルーターの設定が正しいか確認します (詳しくは、パソコン、ルーターの取扱説明書をご覧ください)。この場合、本機の問題ではない可能性があります。
 - 接続テストの結果で「IPv6接続のご利用について」が表示された場合
 - ・ 「アドレス設定 (IPv6)」の設定内容が、ご使用のネットワーク環境に合っているかをご確認ください。
 - ・ ルーターのIPv6設定が有効かご確認ください。
上記を確認してもIPv6の接続ができない場合は、IPv6をご利用いただける契約か、プロバイダーにご確認ください。
- ※ IPv6接続でネットワーク接続をご利用にならない場合は、「IPv6接続」を「利用しない」に変更してください。

お知らせ.....

- アドレス設定 (IPv4) の IP アドレスについて
- 本機に接続されたルーターの DHCP 機能 (IP アドレスを自動的に割り当てる機能) が ON のときは、アドレス設定 (IPv4) の IP アドレスを「自動取得」、「手動設定」のどちらでも設定できます。
(通常は、「自動取得」に設定します。「手動設定」の方法は (P.97) をご覧ください)
- ルーターの DHCP 機能が OFF のときは、「手動設定」にして、プロバイダーから指定されたアドレスを手動で設定します。
- 手動で設定する際は、他の接続機器と IP アドレスが重複しないように設定します。設定する固定 IP アドレスはプライベートアドレスでなければなりません。
- 設定終了後、本機に設定された IP アドレスとルーターのローカル側に設定された IP アドレスのネットワーク ID 部分がそれぞれ同じであることを確認します。(詳しくは、ルーターの取扱説明書をご覧ください)
- アドレス設定 (IPv4) の DNS アドレスについて
- 本機に接続されたルーターの DHCP 機能が ON のときは、アドレス設定 (IPv4) の DNS アドレスを「自動取得」、「手動設定」のどちらでも設定できます。
(通常は、「自動取得」に設定します。「手動設定」の方法は (P.98) をご覧ください)

● 本機に接続されたルーターの DHCP 機能が OFF のときは、アドレス設定 (IPv4) の DNS アドレスを「手動設定」にしてプロバイダーから指定されたものを手動で設定します。(プロバイダーによって設定方法が異なります。プロバイダーとの契約内容に沿った設定をしてください)

■ PPPoE 設定について

● 本機では PPPoE の設定はできません。PPPoE はルーター側に設定してください。(設定にはパソコンが必要です)

用語・・

■ アドレス (IPv4)

ネットワークに接続する場合に、端末に割り当てられる固有の番号です。最大 3 ケタの数字 4 組を点で区切った形式で表現されます。
(例: 111.112.xxx.xxx)

■ アドレス (IPv6)

ネットワークに接続する場合に、端末に割り当てられる固有の番号です。最大 4 ケタの数字または a ~ f までのアルファベット 8 組を「:」で区切った形式で表現されます。(例: 1111:ABCD:xxxx:xxxx:xxxx:xxxx:xxxx:xxxx)

■ DNS サーバー

ドメイン名 (xxx.co.jp など) を IP アドレスに置き換える機能を持つサーバーで、本機では自動的に取得されます。自動で取得できない場合は、手動で、プロバイダーからの資料で指定された DNS サーバーのアドレスを「プライマリアドレス」に入力します。二つある場合は、もう一方を「セカンダリアドレス」に入力します。ご契約のプロバイダーによっては、「ネームサーバー」、「DNS1/DNS2 サーバー」、「ドメインサーバー」などと呼ばれることがあります。

■ サブネットマスク

ネットワークを区切るために、端末に割り当てられる IP アドレスの範囲を限定するためのものです。
(例: 255.255.xxx.xxx)

■ デフォルトゲートウェイ

ネットワーク外のサーバーにアクセスする際に、使用するルーターなどの機器を指定するためのものです。IP アドレスで特定されています。

■ プロキシ

ご契約のプロバイダーから指定があるときだけ設定してください。(例: proxy.xxx.xxx.xxx)
この設定をすると、HTTP プロキシサーバーからファイアウォール (外部からの不正侵入防護壁) を越えて通信先のサーバーにデータを送ることができます。

■ MAC アドレス

ネットワーク上に接続されている機器の識別のために、機器ごとに割り当てられる固有の番号です。

映像を調整する

お好みの映像メニューを選ぶ

- 見る映像の種類に応じて、お好みの映像メニューを選ぶことができます。
 - 映像メニューは、放送/再生の映像や各入力端子・写真再生の映像、信号特性などでそれぞれ記憶させることができます。
- ※ HDR信号を受信しているときは、映像設定はHDR信号にあわせた画質に設定されます。その場合、映像設定にのアイコンが表示されます。

1、設定 を押し、▲・▼と 決定 で「映像設定」⇒「映像メニュー」の順に進む

設定	
映像設定	映像設定 (放送/再生用)
音声設置	映像メニュー あざやか
録画・再生設定	バックライト 100
通信設定	映像調整 >
放送受信設定	フレーム間補正 強
初期設定	音声設定 (放送/再生用)
その他の設定	音声メニュー >
	低音強調 >
	イコライザー >
	サラウンド >
	オートボリューム >

2、お好みの映像メニューを▲・▼で選び、決定 を押し

- 選択できる映像メニューは、視聴している映像の種類によって異なり、選択できない映像メニューは表示されません。

映像モード
あざやか
標準
ライブ
映画

映像メニュー	内 容
あざやか	日中の明るいリビングで、迫力ある映像を楽しむときに適した設定です。
標準	室内で落ち着いた雰囲気を楽しむときに適した設定です。 (日常、ご家庭で使用するときの推奨設定です)
ライブ	暗くした部屋でテレビ番組を見るときに適した設定です。
映画	映画を見るときに適した設定です。(暖か味のある色あいが再現されます)
ゲーム	ゲームのレスポンスを重視した、ゲームをするのに適した設定です。 (HDMI入力、ビデオ入力のときに選択できます)
PC	パソコンの画面を表示するのに適した設定です。(HDMI入力のときに選択できます)
写真	写真(JPEG画像)を表示するのに適した設定です。(写真再生のときに選択できます)

バックライト

● お好みの見やすい画面の明るさに調整できます。

① ◀・▶でお好みの明るさに調整し、決定 を押す

● 「0」～「100」の範囲で調整できます。（調整値が大きくなるほど画面が明るくなります）

お好みの映像に調整する

1、設定 を押し、▲・▼と決定 で「映像設定」⇒「映像調整」の順に進む

設定	
映像設定	映像設定 (放送/再生用)
音声設置	映像メニュー あざやか
録画・再生設定	バックライト 100
通信設定	映像調整 >
放送受信設定	フレーム間補正 強
初期設定	音声設定 (放送/再生用)
その他の設定	音声メニュー >
	低音強調 >
	イコライザー >
	サラウンド >
	オートボリューム >

2、調整する項目を▲・▼で選び、決定 を押す

設定 > 映像設定 (放送/再生用)	
映像メニュー	黒レベル 0
バックライト	色の濃さ 0
映像調整	色あい 0
フレーム間補正	精細感・ノイズ調整 >
	コントラスト感調整 >
	色温度 10
	映像調整を初期値に戻す >

3、以降の手順（P.106まで）でお好みの映像に調整する

●他の項目を調整するときは、手順2から繰り返します。（「黒レベル」、「色の濃さ」、「色あい」の調整時は、▲・▼を押せば調整項目を切り換えることができます）

「映像調整」をした場合

●映像を調整すると、そのときに選択していた「映像メニュー」に調整状態が記憶され、「映像メニュー」の表示に「：メモリー」が加わります。

●調整状態は、放送/再生や各入力端子、写真再生などの区分ごとに記憶されます。たとえば、（放送/再生）の「あざやか：メモリー」と（HDMI1）の「あざやか：メモリー」は、異なる調整をして記憶させることができます。

映像を調整する (つづき)

設定	
映像設定	映像設定 (放送/再生用)
音声設置	映像メニュー あざやか:メモリー
録画・再生設定	バックライト 100
通信設定	映像調整 >
放送受信設定	フレーム間補正 強
初期設定	音声設定 (放送/再生用)
その他の設定	音声メニュー >
	低音強調 >
	イコライザー >
	サラウンド >
	オートボリューム >

「:メモリー」が表示されます。

黒レベル

●映像の暗い部分（黒）の再現性（明るさ）を調整します。

① ◀・▶でお好みの明るさに調整し、決定を押す

●「-50」（暗）～「+50」（明）の範囲で調整できます。

色の濃さ

●映像の色の濃さを調整します。

① ◀・▶でお好みの濃さに調整し、決定を押す

●「-50」（淡）～「+50」（濃）の範囲で調整できます。

色あい

●肌の色に注目して、色合いを調整します。

① ◀・▶でお好みの色合いに調整し、決定を押す

●「-50」（紫）～「+50」（緑）の範囲で調整できます。

精細感・ノイズ調整

●「精細感・ノイズ調整」を選択して決定を押すと、精細感・ノイズ調整のメニューが表示されます。

①調整する項目を▲・▼で選び、決定を押す

●視聴する映像の種類および「映像メニュー」の設定によっては調整や設定ができない項目があります。

設定 > 映像設定 > 映像調整 (放送/再生用)	
黒レベル	シャープネス 0
色の濃さ	MPWG NR オート
色あい	ダイナミックNR オート
精細感・ノイズ調整	
コントラスト感調整	
色温度	
映像調整を初期値に戻す	

②以降の手順で調整する

●他の項目を調整する場合は、手順①から繰り返します。

シャープネス

●映像の鮮明さを調整します。

①◀・▶でお好みの映像に調整し、決定 を押す

●「-50」～「+50」の範囲で調整できます。

MPEG (エムペグ) NR

●デジタル放送やDVDなどの動きの速い映像のブロックノイズ（モザイク状のノイズ）と、モスキートノイズ（輪郭のまわりにつく、ちらつきノイズ）を減らす機能です。

※「映像メニュー」が「ゲーム」、「PC」、「写真」以外のときに設定できます。

①▲・▼で以下から選び、決定 を押す

- ・ オート 映像の種類に応じて自動的に制御されます。
- ・ 手動 手動で調整します。

「手動」にしたとき

(1)◀・▶で調整し、決定 を押す

●「0」で効果がオフになります。「10」で効果が最大になります。

ダイナミックNR

●映像のざらつきやちらつきを減らす機能です。

※「映像メニュー」が「ゲーム」、「PC」、「写真」以外の時に設定できます。

①▲・▼で以下から選び、決定 を押す

- ・ オート 映像の種類に応じて自動的に制御されます。
- ・ 手動 手動で調整します。

「手動」にしたとき

(1)◀・▶で調整し、決定 を押す

●「0」で効果がオフになります。「10」で効果が最大になります。

※通常は「オート」に設定してください。効果を強くすると残像が目立つ場合があります。

コントラスト感調整

●「コントラスト感調整」を選択して決定 を押すと、コントラスト感調整のメニューが表示されます。

①調整する項目を▲・▼で選び、決定 を押す

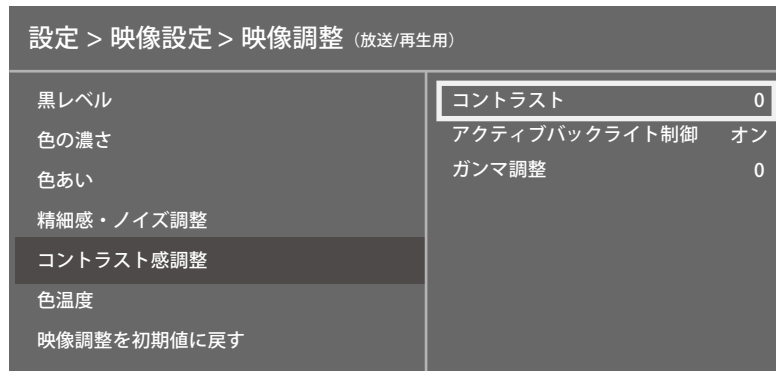

②以降の手順で調整する

●他の項目を調整する場合は、手順①から繰り返します。

映像を調整する (つづき)

コントラスト

● 映像のコントラスト、明るさ、色の濃さをバランスよく同時に調整します。

① ◀・▶でお好みの映像に調整し、決定を押す

● 「-50」～「+50」の範囲で調整できます。（数値が大きくなるほど映像のコントラストが強くなります）

アクティブバックライト制御

● 映像の明るさに応じてバックライトの明るさを自動調整し、メリハリのある映像にします。

① ▲・▼で以下から選び、決定を押す

- ・オン アクティブバックライト制御の機能が働きます。
- ・オフ この機能は働きません。

ガンマ調整

● 映像の暗い部分と明るい部分の階調のバランスを調整することができます。

① ▲・▼で調整し、決定を押す

調整範囲	
-10～+10	調整値が大きくなるほど画面全体が明るくなります。

色温度

● 画面全体の色味を調整します。

① ◀・▶で調整し、決定を押す

● 「0」～「+10」の範囲で調整できます。

調整値が小さくなるほど暖色系、大きくなるほど寒色系になります。

● 青を押すと、「RGBゲイン調整」に切り換えることができます。

▲・▼で「Rゲイン」(赤)、「Gゲイン」(緑)または「Bゲイン」(青)を選び、◀・▶で調整する

● 明るい部分の色温度を微調整します。

調整範囲	
-30～+30	調整値が大きくなるほど、選んでいる色の色味が強くなります。

映像調整を初期値に戻す

● 「映像調整」の内容を、お買い上げ時の設定・調整に戻します。

1、設定を押し、▲・▼と決定で「映像設定」⇒「映像調整」⇒「映像調整を初期値に戻す」の順に進む

2、◀・▶で「はい」を選び、決定を押す

フレーム間補正

● 映画やアニメなどコマ数が少ない映像に対し、なめらかな動きで映像を表示する機能です。

※ 映像メニューが「ゲーム」、「PC」、「写真」以外のときに設定できます。

① ▲・▼で以下から選び、決定を押す

- ・強 映画やアニメが最もなめらかな動きで表示されます。
- ・弱 映画やアニメがなめらかな動きで表示されます。
- ・オフ 元の入力映像をそのまま表示します。

音声を調整する

お好みの音声メニューを選ぶ

- 見る番組の種類に応じて、お好みの音声メニューを選ぶことができます。
- 音声メニューは、放送/再生の音声、各外部入力端子の音声、音楽再生の音声でそれぞれ記憶させることができます。
- サブメニューの「スピーカー切替」が「テレビスピーカ―」、「外部スピーカ―」以外の場合は、「音声メニュー」は「―」と表示され、操作できません。

1、設定 を押し、▲・▼と決定 で「音声設定」⇒「音声メニュー」の順に進む

設定	
映像設定	音声設定 (放送/再生用)
音声設置	音声メニュー ダイナミック
録画・再生設定	低音強調 弱
通信設定	イコライザー >
放送受信設定	サラウンド オフ
初期設定	オートボリューム オフ
その他の設定	左右バランス 中央
	ドルビーDRC ―
	音声出力詳細設定 >
	音声設定 (放送/再生用)
	USBハードディスク設定 >
	録画設定 >

2、お好みの音声メニューを▲・▼で選ぶ

音声メニュー	ダイナミック < 標準 > 映画
低音強調	オフ
イコライザー	>
サラウンド	オフ
オートボリューム	オフ
ニュースや情報番組などを 楽しむときに適した設定です。	
十字で選び 戻るで前画面 赤 調整値を初期値に戻す	

音声メニュー	内容
ダイナミック	音楽やドラマなどを楽しむときに適した設定です。
標準	ニュースや情報番組などを楽しむときに適した設定です。
映画	映画を鑑賞するときに適した設定です。

- ▲・▼で、低音強調画面やイコライザー画面に移行できます。

お好みの音声に調整する

- 1、設定 を押し、▲・▼で「音声設定」を選んで 決定 を押す
- 2、▲・▼で調整したい項目を選んで 決定 を押す
- 3、以下の手順でお好みの音声に調整する

音声を調整した場合

- 調整や設定をすると、そのときに選択していた「音声メニュー」に調整・設定状態が記憶され、「音声メニュー」の表示に「：メモリー」が加わります。
- 調整・設定状態は、入力端子などの区分ごとに記憶されます。たとえば、（放送/再生）の「ダイナミック：メモリー」と（HDMI1）の「ダイナミック：メモリー」は、異なる調整をして記憶させることができます。

低音強調

- 低音の強さを調整します。

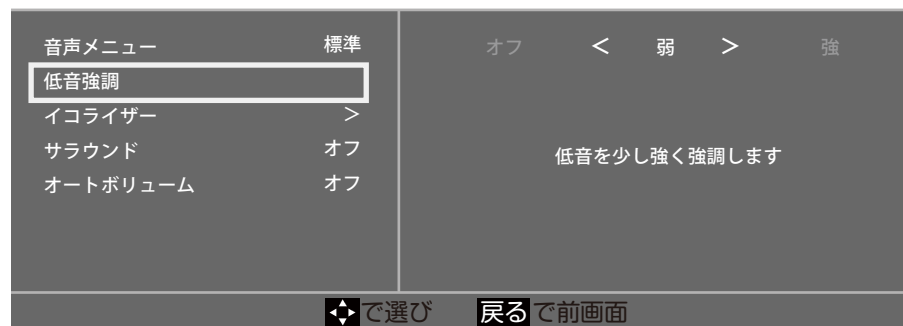

- ① ◀・▶でお好みの設定を選ぶ

- ・ 強/弱 低音をお好みの強さに調整します。
- ・ オフ この機能は働きません。

イコライザー

- イコライザーで音質をより詳細に調整できます。
- サブメニューの「スピーカー切替」が「テレビスピーカー」、「外部スピーカー」以外の場合は、「イコライザー」は「—」と表示され、操作できません。

- ① 調整する音域を◀・▶で選び、▲・▼でレベルを変える

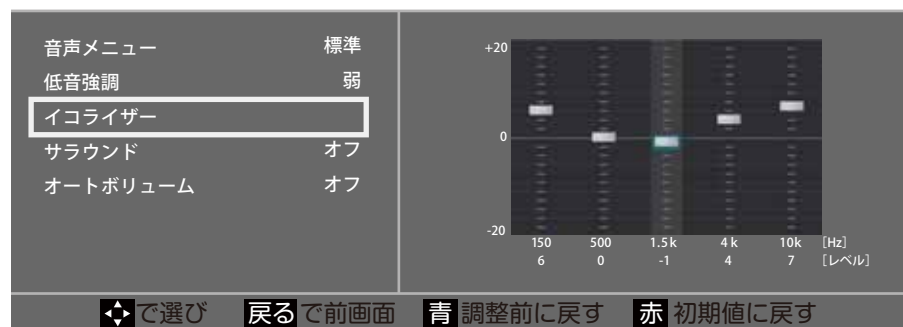

- 調整前の音に戻すには、青 を押します。
- お買い上げ時の調整に戻すには、赤 を押します。

サラウンド

● ステレオ音声に、広がりを持たせます。

● サブメニューの「スピーカー切替」が「テレビスピーカー」、「外部スピーカー」以外のときは、「サラウンド」は「ー」と表示され、操作できません。

※音声多重放送の視聴時に、「主」または「副」(P.32)を選んでいる場合は、効果が得られません。

① ◀・▶でお好みの設定を選び、決定 を押す

- ・ライブ ステレオ放送や、接続機器からのステレオ信号で、左右への広がりが出ます。
- ・シネマ ステレオ放送や、接続機器からのステレオ信号で、左右への広がりに合わせて、奥行き感も加わります。
- ・オフ この機能は働きません。

オートボリューム

● コンテンツの違いなどで生じる音量差を調整して、音声を聴きやすくします。

● サブメニューの「スピーカー切替」が「テレビスピーカー」、「外部スピーカー」以外のときは、「オートボリューム」は「ー」と表示され、操作できません。

① ◀・▶で以下から選び、決定 を押す

- ・オン オートボリュームの機能が働きます。
- ・オフ この機能は働きません。

左右バランス

● スピーカー、ヘッドホンの左右の音量バランスを調整します。

● サブメニューの「スピーカー切替」が「テレビスピーカー」、「外部スピーカー」以外のときは、「左右バランス」は「ー」と表示され、操作できません。

① ◀・▶でお好みのバランスに調整し、決定 を押す

ドルビーDRC

● コンテンツの違いなどで生じる音量差を調整して、音声を聴きやすくします。

● HDMI入力端子に接続した機器から、ドルビーデジタルやドルビーデジタルプラスで記録されたコンテンツが入力された場合にだけ機能します。(機器からドルビーデジタルやドルビーデジタルプラスの音声信号が出力されるよう接続機器側で設定してください)

① ▲・▼で以下から選び、決定 を押す

- ・強 音声レベルの補正効果が強く働きます。
- ・弱 音声レベルの補正効果が弱く働きます。

音声出力詳細設定

● スピーカーや音声出力端子から出力する音声の詳細を設定できます。

① 調整する項目を▲・▼で選び、決定 を押す

② 以降の手順で調整する

- 他の項目を調整する場合は、手順①から繰り返します。

お好みの音声に調整する (つづき)

デジタル音声出力

- 光デジタル音声出力端子またはHDMI入力1(ARC)端子から出力する音声信号の設定です。
- オーディオ機器が対応している音声信号については、オーディオ機器の取扱説明書でご確認ください。
- オーディオ機器から音声が出ない、または正常に再生できない場合は、「PCM」に設定してください。

① ▲・▼で信号を選び、決定 を押す

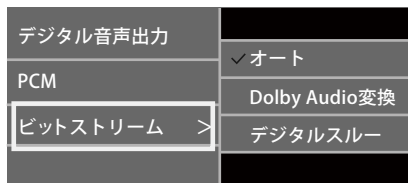

- ・PCM 常にリニア PCM 信号が出力されます。オーディオ機器がリニア PCM 信号だけに対応している場合は、この設定にします。
- ・オート 信号が自動で出力されます。
- ・Dolby Audio 変換 Dolby 信号に変換して出力します。
- ・デジタルスルー AAC や Dolby 信号がそのまま出力されます。

ご注意

- 非対応の音声フォーマットを対応と通知してくる ARC 対応機器もあります。その場合、非対応音声フォーマットの再生中は音が出なくなります。
- 本機から出力されるデジタル音声は、デジタル音声出力設定を「PCM」以外に設定するとコンテンツによってはオーディオ機器 (AV アンプなど) で正常に再生できない形式があります。

お知らせ

- デジタル音声出力設定が「PCM」以外に設定されている場合で、MPEG-2 AAC 音声の場合には、データ放送の一部の音声 (効果音など) が光デジタル音声出力端子または HDMI 入力 1(ARC) 端子から出力されないことがあります。
- 外部入力としてビデオ入力を選択しているときは、光デジタル音声出力端子および HDMI 入力 1(ARC) 端子からは設定にかかわらずリニア PCM 信号が出力されます。
- HDMI 入力の選択時に、HDMI 入力端子が対応していない音声信号が入力された場合は、設定にかかわらず光デジタル音声出力端子または HDMI 入力 1(ARC) 端子から信号は出力されません。(HDMI 入力端子が対応している音声信号については、(P.70) をご覧ください)

デジタル音声出力タイミング

- 光デジタル音声出力端子と HDMI 入力 1(ARC) 端子から出力するデジタル音声信号のタイミングを設定することができます。

① ◀・▶でお好みのタイミングに調整し、決定 を押す

- 数値が小さくなるほど、音声を出力するタイミングが早くなります。

お知らせ

- 映像の遅延が小さい場合、設定を変えても音声のタイミングは変わりません。

ヘッドホン／音声出力設定

●ヘッドホン／音声出力端子の設定をします。

①▲・▼で「ヘッドホン／音声出力設定」を選び、決定 を押す

●以下、「出力設定」、「ヘッドホン出力設定」、「外部スピーカー出力設定」を設定します。

出力設定

●ヘッドホン／音声出力端子に接続する機器にあわせて設定します。

※ヘッドホンで聴くときは、必ず「ヘッドホン」に設定してください。

①▲・▼で以下から選び、決定 を押す

- ・ヘッドホン・・・・・・・・・・ヘッドホン／音声出力端子にヘッドホンを接続する場合に選択します。
- ・外部スピーカー・・・・・・・・・・ヘッドホン／音声出力端子に AV アンプやミニコンポなどを接続する場合に選択します。

ヘッドホン出力設定

●「出力設定」で「ヘッドホン」を選んだときに設定します。

① ▲・▼で以下から選び、決定 を押す

- ・通常モード・・・・・・・・・・ヘッドホン／音声出力端子にヘッドホンを接続すると、本機のスピーカーからの音が消え、ヘッドホンから音が聞こえます。
- ・親切モード・・・・・・・・・・ヘッドホン／音声出力端子にヘッドホンを接続すると、本機のスピーカーとヘッドホンの両方から音が聞こえます。

外部スピーカー出力設定

●「出力設定」で「外部スピーカー」を選んだときに設定します。

① ▲・▼で以下から選び、決定 を押す

- ・固定・・・・・・・・・・ヘッドホン／音声出力端子から一定の音量レベルで音声出力されます。外部接続機器で音量を調節してください。
- ・可変・・・・・・・・・・ヘッドホン／音声出力端子からの音量を本機のリモコンで調節することができます。

その他の設定をする

アンテナを調整する

電波の強さ（信号強度）を確認する

●テレビが全く映らない、または画面が乱れるなどの場合は、以下の手順でアンテナレベルを確認します。

地上デジタル用アンテナの場合

1、設定 を押し、▲・▼と決定で「放送受信設定」⇒「地上デジタル設定」⇒「地上デジタルアンテナ設定」の順に進む

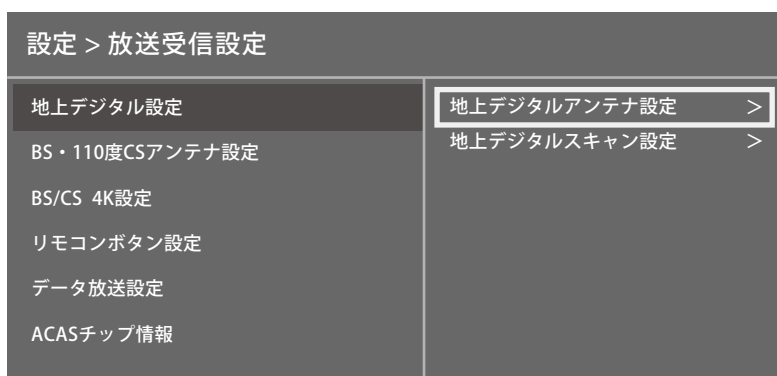

2、▲・▼で「伝送チャンネル」を選び、決定 を押す

3、▲・▼でチャンネルを選び、決定 を押す

●お住まいの地域の地上デジタル放送に使用されている伝送チャンネルを選びます。（お買い上げの販売店などにお聞きください）

●信号強度（○印の数値）が推奨範囲内になっているか、信号品質（○印の数値）が推奨の数値以上になっているかを確認します。

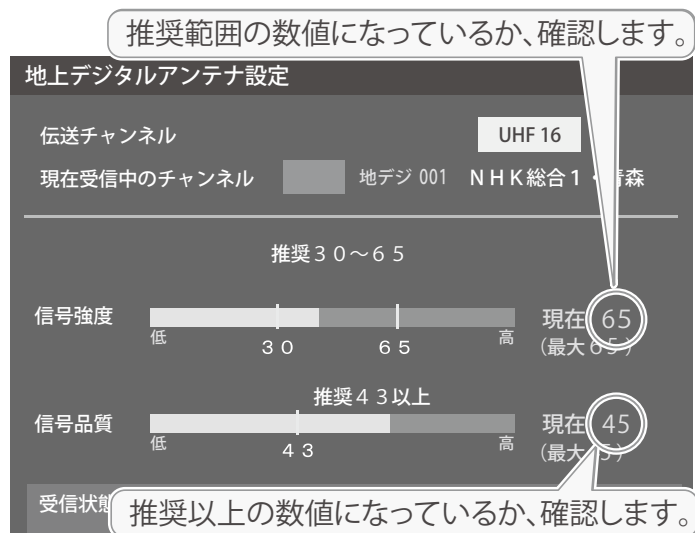

BS・110度CS用アンテナの場合

- 1、設定 を押し、▲・▼と 決定 で「放送受信設定」⇒「BS・110度CSアンテナ設定」の順に進む
- 2、BS または CS で放送の種類を選ぶ
- 3、チャンネル でチャンネルを選ぶ
 - 無料チャンネルまたは契約済チャンネルを選びます。
 - 信号強度が推奨範囲内になっているか、信号品質が推奨数値以上になっているかを確認します。

BS・110度CS 4K放送用アンテナの場合

- 1、設定 を押し、▲・▼と 決定 で「放送受信設定」⇒「BS/CS 4K設定」⇒「BS/CS 4Kアンテナ設定」の順に進む
- 2、チャンネル でチャンネルを選ぶ
 - 無料チャンネルまたは契約済チャンネルを選びます。
 - 信号強度が推奨範囲内になっているか、信号品質が推奨数値以上になっているかを確認します。

お知らせ・・

- アンテナレベルの信号強度の数値は、受信入力電力を換算したものです。
- アンテナレベルの信号品質の数値は、受信 C/N を換算したものです。（「受信 C/N」とは放送電波と雑音電波の比を表すもので、電波の品質を知るときの目安となります）

アンテナを調整する

- 衛星を使用していて、アンテナレベルが不足している場合は、「アンテナレベル」の画面を確認しながらアンテナの調整をします。

※高所での作業は危険です。アンテナの調整については、販売店にご相談ください。

- 1、アンテナをゆっくり動かして、アンテナレベルの数値が最大となるように調整する
 - 画面のアンテナレベルの最大値を参考に、アンテナを固定したあとにレベル値が下がっていないことを確認します。
- 2、アンテナを固定して、決定 を押す

その他の設定をする (つづき)

BS・110度CS用アンテナ電源供給の設定を変更する

- BS・110度CS用アンテナは電源を必要とします。
- お買い上げ時は、「する」に設定されています。マンションなどで、他の機器からアンテナに電源が供給されているときは、「しない」に設定します。

1、設定 を押し、▲・▼と決定で「放送受信設定」⇒「BS・110度CSアンテナ設定」の順に進む

設定	
映像設定	放送受信設定
音声設置	地上デジタル設定 >
録画・再生設定	BS・110度CSアンテナ設定 >
通信設定	BS/CS 4K設定 >
放送受信設定	リモコンボタン設定 >
初期設定	データ放送設定 >
その他の設定	ACASチップ情報 >
	初期設定
	はじめての設定 >
	その他の設定
	視聴制限設定 >

2、▲・▼で「衛星アンテナ電源供給」を選び、決定 を押し

3、▲・▼で「する」または「しない」を選び、決定 を押し

アンテナ線がショートしたとき

- BS・110度CS用アンテナのレベル表示画面に「アンテナ線がショートしています。」のメッセージが表示された場合は電源を切ってから電源プラグを抜き、ショートの原因を取り除いてからもう一度電源を入れてアンテナレベル表示の操作をしてください。
- マンションなどの共聴アンテナを使用しているときは、以下のエラーメッセージは表示されず、「衛星アンテナ電源供給」の設定が「しない」に切り換わります。

①アンテナ線がショートしています。
アンテナ線の接続を確認してください。
コード：E209

お知らせ.....

- 「衛星アンテナ電源供給」を「する」に設定した場合でも、本機の電源が「切」または「待機」のときは、番組情報の取得中や予約した番組の録画中、およびダウンロード中などの場合以外はアンテナ電源が供給されません。(BS・110度CSデジタル放送を録画機器単独で録画するときなどは、録画機器からアンテナ電源を供給する必要があります)

チャンネルを追加したり設定を変更したりするとき

地上デジタルチャンネルを自動で設定する

●地上デジタル放送には以下の3種類のチャンネル自動設定機能があります。

- ・ 初期スキャン・・・「はじめての設定」の「①地上デジタルチャンネル設定」で行われる「初期スキャン」だけをやり直すことができます。
- ・ 再スキャン・・・放送局が増えたなど、放送チャンネルに変更があったときに、ワンタッチ選局ボタンに設定できます。
- ・ 自動スキャン・・・本機の電源が「切」や「待機」のときに自動的に探し、変更されたチャンネルがあればワンタッチ選局ボタンに自動で設定されます。

※ 初期スキャンをしていないと、再スキャンや自動スキャンはできません。

初期スキャンをするとき

●受信可能なチャンネルを本機が探し、ワンタッチ選局ボタン（ 1 ～ 12 ）に放送の運用規定に基づいて設定します。

- 1、設定 を押し、▲・▼と決定 で「放送受信設定」⇒「地上デジタル設定」⇒「地上デジタルスキャン設定」⇒「初期スキャン」の順に進む
- 2、お住まいの地方を▲・▼・◀・▶で選び、決定 を押す
- 3、お住まいの都道府県または地域を▲・▼・◀・▶で選び、決定 を押す

再スキャンするとき

●新たに放送局が開局してチャンネルが増えた場合など、放送に変更があった場合は、「再スキャン」をすればチャンネルを追加設定することができます。

- 1、設定 を押し、▲・▼と決定 で「放送受信設定」⇒「地上デジタル設定」⇒「地上デジタルスキャン設定」⇒「再スキャン」の順に進む

自動スキャンの設定を変えるとき

●お買い上げ時は自動スキャンは「する」に設定されています。チャンネル設定の内容が自動変更されないようにする場合は、自動スキャンを「しない」に設定してください。

- 1、設定 を押し、▲・▼と決定 で「放送受信設定」⇒「地上デジタル設定」⇒「地上デジタルスキャン設定」⇒「自動スキャン」の順に進む
- 2、▲・▼で「する」または「しない」を選び、決定 を押す

その他の設定をする (つづき)

視聴しないチャンネルをスキップする

- チャンネル で選局するとき、視聴しないチャンネルを飛ばすことができます。
 - 「スキップ」に設定したチャンネルは番組表 (P.16) に表示されません。また、番組検索 (P.23) の対象になりません。
- 1、設定 を押し、▲・▼と決定 で「放送受信設定」⇒「リモコンボタン設定」⇒「チャンネルスキップ設定」の順に進む
 - 放送の種類を選択する画面が表示されます。
 - 2、設定する放送の種類を▲・▼で選び、決定 を押す
 - 3、スキップ設定を変更したいチャンネルを▲・▼で選び、決定 を押す
 - 図は手順2で「地上デジタル」を選んだ場合の例です。

チャンネルスキップ設定		地上デジタル
チャンネル		スキップ
011	NHK総合1・東京	しない
012	NHK総合2・東京	しない
021	NHKEテレ1東京	しない
022	NHKEテレ2東京	しない
023	NHKEテレ3東京	しない
031	t v k 1	しない
032	t v k 2	しない
033	t v k 3	しない
041	日テレ1	する
042	日テレ2	する
051	テレビ朝日	する
052	テレビ朝日	しない

- 決定 を押すたびに「する」⇔「しない」と交互に切り換わります。
- 他のチャンネルの設定をする場合は、手順3の操作を繰り返します。(違う放送のチャンネルを設定する場合は戻る を押し、手順2からの操作を繰り返します)

お知らせ・・

- チャンネルスキップ設定について
- 放送局の代表チャンネルを「する」に設定すると、その放送局の代表チャンネル以外のチャンネルもスキップされます。代表チャンネル以外のチャンネルを「する」に設定した場合は、代表チャンネルは選局できます。
- お買い上げ時には、BS/CS 4K 放送の102チャンネルはスキップ「する」に設定されています。

データ放送の設定をする

地域と郵便番号を設定する

- お住まいの地域に応じたデータ放送や緊急警報放送などを視聴するための設定です。
- 「はじめての設定」で設定した状態から変更したいときに以下の操作をします。

地域を設定する

- 1、設定 を押し、▲・▼と決定 で「放送受信設定」⇒「データ放送設定」⇒「地域設定」の順に進む
- 2、該当する地方を▲・▼・◀・▶で選び、決定 を押し
 - 「設定しない」を選んだ場合は、これで終わりです。
- 3、該当する地域を▲・▼・◀・▶で選び、決定 を押し
 - 伊豆、小笠原諸島地域の方は「東京都島部」を選んでください。
 - 南西諸島の鹿児島県地域の方は「鹿児島県島部」を選んでください。

郵便番号を設定する

- 1、設定 を押し、▲・▼と決定 で「放送受信設定」⇒「データ放送設定」⇒「郵便番号」の順に進む
 - 郵便番号の入力画面が表示されます。
- 2、お住まいの地域の郵便番号を 1 ～ 10 (0)で入力し、決定 を押し
 - 上3ケタを入力して決定 を押し、残り4ケタは自動的に「0」が入力されます。

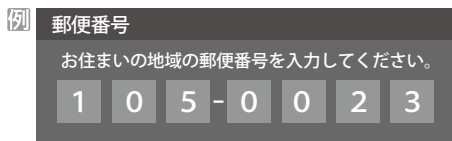

災害発生時に文字情報を表示させる

- デジタル放送には文字スーパー表示機能があり、災害時の速報などに使用されます。複数言語の文字スーパーに対応した番組の場合には、表示する言語を選択することができます。
- お買い上げ時は、文字スーパーが日本語優先で表示されるように設定されています。

- 1、設定 押し、▲・▼と決定 で「放送受信設定」⇒「データ放送設定」⇒「文字スーパー表示」の順に進む
 - 「文字スーパー表示」の画面が表示されます。
- 2、▲・▼で「する」を選び、決定 を押し

その他の設定をする (つづき)

文字スーパーの言語を設定する

1、設定 を押し、▲・▼と 決定 で「放送受信設定」⇒「データ放送設定」⇒「文字スーパー言語」の順に進む

●「文字スーパー言語」の画面が表示されます。

2、優先する言語を▲・▼・◀・▶で選び、決定 を押す

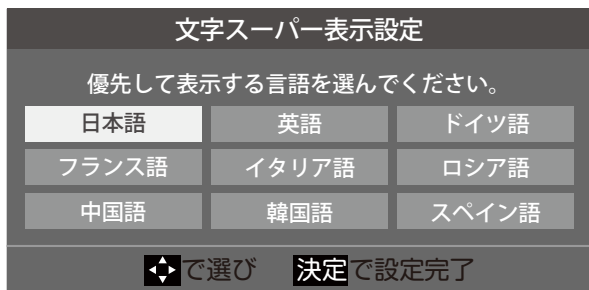

ルート証明書の番号を確認する

●地上デジタル放送の双方向サービスで、本機と接続するサーバーの認証をする際に使用されるルート証明書の番号を確認することができます。

●ルート証明書は地上デジタル放送で放送局から送られます。

1、設定 を押し、▲・▼と 決定 で、「放送受信設定」⇒「データ放送設定」⇒「ルート証明書番号」の順に進む

●ルート証明書番号のリストが表示されます。

2、ルート証明書番号を確認し、決定 を押す

お知らせ.....

■郵便番号と地域の設定について

●データ放送を視聴している状態で設定を変更した場合、放送によっては、設定終了後そのままの状態では設定内容は反映されません。設定終了後に再度データ放送を選局してください。

■文字スーパー表示の設定について

●設定した言語の文字スーパーがあるときは、その言語で表示されます。設定した言語が視聴している放送にない場合は、その放送に従って表示されます。

●「しない」を選択した場合でも、災害時などの速報は、放送局指定によって放送受信時に強制表示することがあります。

用語.....

■ルート証明書

サーバーを認証する第三者機関(認証局)を証明するものです。この証明書を基にして、「サーバー証明書」のデジタル署名を検証し、「サーバー証明書」が信頼できる事を確認します。

視聴できる番組を制限する

制限するために暗証番号を設定する

- 暗証番号は、視聴年齢制限のある番組を見たりするときが必要です。
- 暗証番号を設定した場合には、暗証番号の変更・削除および「すべての初期化」(P.121)をするときにも暗証番号の入力が必要になります。

ご注意・・

- 暗証番号を忘れないようにご注意ください。
- ※必要としない場合は、登録しないことをおすすめします。

- 1、設定 を押し、▲・▼と決定 で「その他の設定」⇒「視聴制限設定」⇒「暗証番号設定」の順に進む
 - 暗証番号の入力画面が表示されます。
- 2、暗証番号を変更する場合は、変更前の暗証番号を 1 ～ 10 (0)で入力する
 - 新規設定の場合、この手順はありません。
- 3、登録したい暗証番号を 1 ～ 10 (0)で入力する
 - 間違えて入力した場合は、◀を押し、もう一度入力します。
 - 入力した数字は画面には「*」で表示されます。

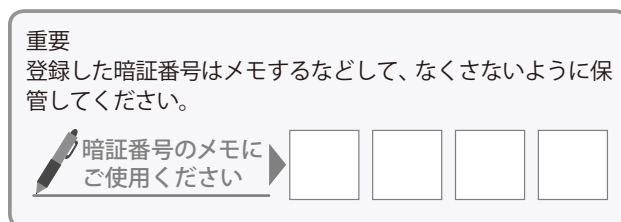
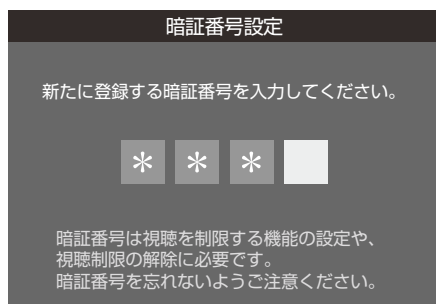

- 4、1 ～ 10(0)でもう一度同じ暗証番号を入力する
- 5、確認画面で決定 を押す

暗証番号を削除するとき

- 1、設定 を押し、▲・▼と決定 で「その他の設定」⇒「視聴制限設定」⇒「暗証番号削除」の順に進む
 - 暗証番号の入力画面になります。
- 2、1 ～ 10(0)で暗証番号を入力する
- 3、確認画面で、◀・▶で「はい」選び、決定 を押す

その他の設定をする (つづき)

番組の視聴を制限する

- デジタル放送では番組ごとに視聴年齢が設定されている場合があります。視聴年齢制限のある番組を見るには設定が必要です。
- お買い上げ時には、番組の視聴制限は設定されていません。
- 暗証番号を設定していない場合は、先に暗証番号を設定します。

1、設定 を押し、▲・▼と 決定 で「その他の設定」⇒「視聴制限設定」⇒「放送視聴制限設定」の順に進む

- 暗証番号の入力画面になります。

2、1 ～ 10(0)で暗証番号を入力する

3、◀・▶で年齢を設定し、決定 を押す

- 設定できる年齢は、4歳から20歳までです。
- 視聴年齢制限機能を使わない場合は、「20歳（制限しない）」に設定します。

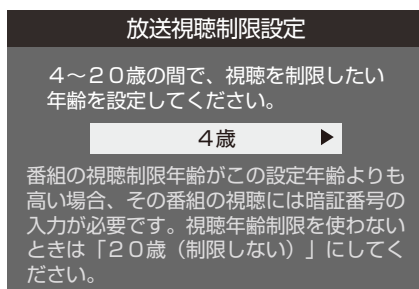

- 視聴時の動作および必要な操作は以下のとおりです。

番組の制限年齢が設定した年齢よりも上の場合

- メッセージが表示されます。
- 決定 を押し、1 ～ 10(0)で暗証番号を入力します。

視聴年齢制限が設定されていない場合

- 視聴年齢制限のある番組を見ることはできません。
- 決定 を押し、設定が必要な項目を設定します。

お買い上げ時の設定に戻すには（設定内容を初期化するには）

- お買い上げ時の設定（工場出荷設定）に戻します。

ご注意・・

※ 初期化をすると初期化前の状態に戻すことはできませんのでご注意ください。

項目	内容
すべての初期化	●本機に設定されたすべての内容をお買い上げ時の状態に戻します。 ※この初期化は、データ放送の個人情報（住所、氏名、視聴ポイント数など）などについてもすべて初期化されますので、本機を廃棄処分する場合や他の人に譲り渡す場合にだけ行ってください。

- 1、設定 を押し、▲・▼と決定 で「その他の設定」⇒「設定の初期化」の順に進む

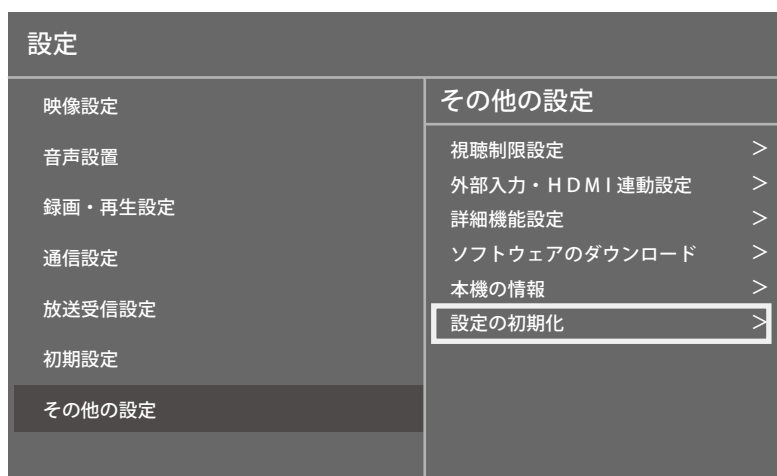

- 2、「すべての初期化」を選び、決定 を押す

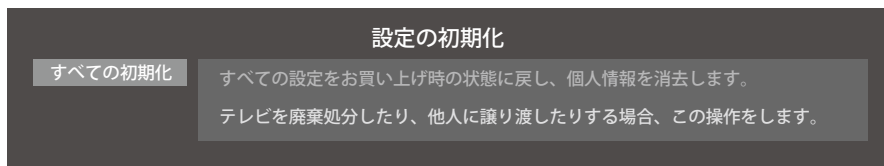

- 3、初期化する場合は◀・▶で「はい」を選び、決定 を押す

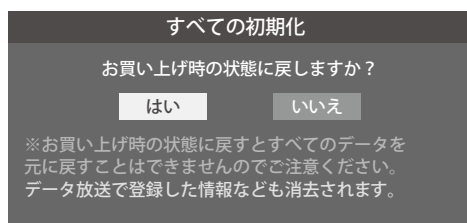

- 4、初期化終了の画面が表示されたら、電源を切る

ソフトウェアを更新する

ソフトウェアの更新機能について

- 本機は、内部に組み込まれたソフトウェア（制御プログラム）で動作するようになっています。
- お買い上げ後、より快適な環境でお使いいただくために、ソフトウェアを更新する場合があります。
- 更新用のソフトウェアはBSデジタルや地上デジタルの放送電波で送られてきます。本機は、放送電波で送られてくる更新用のソフトウェアを自動的にダウンロードし、内部ソフトウェアを自動的に更新する機能を備えています。

ソフトウェアの自動ダウンロードについて

- 「自動ダウンロード」の設定を「する」（お買い上げ時の設定）にしておき、日常的にデジタル放送を視聴し、視聴しないときにも電源プラグをコンセントに差し込んだままにしておけば、特別に意識する必要はありません。放送電波での更新用のソフトウェアを自動的にダウンロードし、内部ソフトウェアを自動的に更新することができます。更新用のソフトウェアがある場合は、ダウンロード情報が放送電波で送られます。本機は、地上デジタル放送またはBSデジタル放送を視聴しているときにダウンロード情報を取得します。（情報を確認する操作はありません）。

自動ダウンロードの設定を変更する

- 1、設定 を押し、▲・▼と決定 で「その他の設定」⇒「ソフトウェアのダウンロード」⇒「自動ダウンロード」の順に進む
- 2、◀・▶で「する」または「しない」を選び、決定 を押し
 - 青 を押すと、放送電波でのダウンロード予定を一覧で確認することができます。
 - 「しない」を選んだときは、「ソフトウェア更新のお知らせ」の設定が「表示する」に自動的に変更されます。

ソフトウェア更新のお知らせ画面を表示させないようにする

- ソフトウェア更新のお知らせ画面は、以下の操作で表示させないようにすることもできます。
- ① 設定 ⇒「その他の設定」⇒「ソフトウェアのダウンロード」⇒「ソフトウェア更新のお知らせ」の順に進む
 - ② ▲・▼で「表示しない」を選び、決定 を押し
 - 上記の操作で「表示する」を選ぶと、ソフトウェア更新のお知らせ画面が表示されるようになります。
 - 「自動ダウンロード」を「する」に設定している場合、「ソフトウェア更新のお知らせ」は「しない」に設定され、変更することはできません。

ソフトウェアのバージョンを確認するには

- 1、サブメニュー を押し、▲・▼と決定 で「その他の操作」⇒「本機の情報」の順に進む
 - 設定 ⇒「その他の設定」⇒「本機の情報」でも確認できます。

用語

- ダウンロード
放送電波を使って、ソフトウェアなどを端末（この場合は本機）に転送することです。

お知らせ.....

- 電源プラグがコンセントから抜かれていると、自動ダウンロードができないため、ソフトウェアの自動更新は行われません。
- ダウンロードによって、一部の設定内容がお買い上げ時の状態に戻ったり、予約やお知らせが削除されたりする場合があります。
- 悪天候などでダウンロードが取り消された場合は、「本機に関するお知らせ」でお知らせします。
- テレビの状態によっては、ソフトウェアの更新が行われない場合があります。

お知らせを見る

●お知らせには、「放送局からのお知らせ」、「本機に関するお知らせ」、「ボード」の3種類があります。

●未読のお知らせ（「ボード」を除きます）があると、チャンネル切換時や 画面表示 を押したときに、画面に「お知らせアイコン」が表示されます。（P.128）

1、サブメニュー を押し、▲・▼と 決定 で「その他の操作」⇒「お知らせ」の順に進む

2、▲・▼でお知らせの種類を選び、決定 を押す

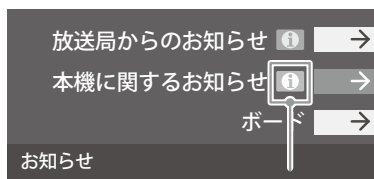

未読のお知らせはオレンジ色で表示されます。

- ・放送局からのお知らせ・・・デジタル放送局からのお知らせです。
- ・本機に関するお知らせ・・・本機が発行したお知らせです。
- ・ボード・・・・・・・・・・110度CSデジタル放送の視聴者に向けたお知らせです。

3、読みたいお知らせを▲・▼で選び、決定 を押す

●選択したお知らせの内容が表示されます。

画面に「本機のお知らせを確認」が表示されたときは

青 本機のお知らせを確認

① 青 を押す

●「本機に関するお知らせ」が表示されます。

●お知らせが複数件ある場合は、「本機に関するお知らせ」一覧が表示されます。▲・▼で確認するお知らせを選び、決定 を押して表示させます。

「本機に関するお知らせ」を削除するには

※削除できるのは「本機に関するお知らせ」のみです。

①「本機に関するお知らせ」の画面で、青 を押す

②◀・▶で「はい」を選び、決定 を押す

※本機に関するお知らせがすべて削除されます。

ACASチップ情報を確認する

- ACASチップの状態やID番号などをテレビ画面で確認することができます。
- ACASチップは、新しいCASの方式です。本機には、この新CASのプログラムを書き込んだ「ACASチップ」が搭載されています。
- ※ ACASチップには、これまでのB-CASカードの機能も含まれています。（B-CASカードは付属していません）

ACASチップ情報を確認する

- 1、設定 を押し、▲・▼と決定 で「放送受信設定」⇒「ACASチップ情報」の順に進む
- ACASチップの情報が表示されます

ACASチップ情報	
識別番号 ID番号	XXXX XXXX-XXXX-XXXX-XXXX-XXXX-
状態	正常に動作しています。

- 2、 情報を確認したら、 戻る を押す

ACASチップID番号記入欄

- 下欄にACASチップのID番号を記入しておくこと、有料放送のご契約やお問い合わせの際などに役立ちます。

ACASチップ

--	--	--	--	--	--	--	--	--	--	--	--	--	--	--	--	--	--	--	--	--

お知らせ・・

- 「お知らせ」について
 - 「放送局からのお知らせ」は、地上デジタル放送が7通まで記憶され、BS デジタル放送と 110度CS デジタル放送は、合わせて24通まで記憶されます。放送局の運用によっては、それより少ない場合もあります。記憶できる数を超えて受信した場合は、古いものから順に削除されます。
 - BS 4K 放送と CS 4K 放送は、それぞれ10通まで記憶されます。
 - 「本機に関するお知らせ」は、既読の古いものから順に削除される場合があります。
 - 「ボード」は110度CS デジタル放送のそれぞれに対し、今送信されているものが50通まで表示されます。
 - 「お知らせアイコン」は、未読のお知らせが1件でも残っていると表示されます。

対応フォーマット

本機で対応しているHDMI入力信号フォーマット

- 「VESA 規格」の欄に「○」が記載されている信号フォーマットは、本機の HDMI 入力端子では VESA 規格に準拠する信号フォーマットにだけ対応しています。機器によっては本機の画面に映像が表示されないか、または正しく表示されないことがあります。その場合は下表に示した入力信号のどれかに合うようにパソコンや映像機器の設定を変更してください。一部のパソコンでは有効画面領域を「解像度」と表記する場合があります、その場合は本機が表示する解像度と異なることがあります。
- 下表すべての信号に対応していますが、パソコンを接続する場合はリフレッシュレートが 60Hz の信号を推奨します。

フォーマット名	表示解像度	リフレッシュレート	水平周波数	ピクセルロック	VESA規格
480i	720X480	59.94/60Hz	15.734 / 15.750kHz	27.000 / 27.027MHz	
480p	720X480	59.94/60Hz	31.469 / 31.500kHz	27.000 / 27.027MHz	
1080i	1920X1080	59.94/60Hz	33.716 / 33.750kHz	74.176 / 74.250MHz	
720p	1280X720	59.94/60Hz	44.955 / 45.000kHz	74.176 / 74.250MHz	
1080p	1920 × 1080	59.94/60Hz	67.433 / 67.500kHz	148.352 / 148.500MHz	
		23.98/24Hz	26.973 / 27.000kHz	74.176 / 74.250MHz	
		29.97/30Hz	33.716 / 33.750kHz	74.176 / 74.250MHz	
2160p	3840X2160	59.94/60Hz	134.865 / 135.000kHz	593.407 / 594.000MHz	
		23.98/24Hz	53.946 / 54.000kHz	296.703 / 297.000MHz	
		29.97/30Hz	67.433 / 67.500kHz	296.703 / 297.000MHz	
2160p (SMPTE)	4096X2160	23.98/24Hz	53.946 / 54.000kHz	296.703 / 297.000MHz	
		29.97/30Hz	67.433 / 67.500kHz	296.703 / 297.000MHz	
VGA	640X480	59.94/60Hz	31.469 / 31.500kHz	25.175 / 25.200MHz	○
SVGA	800X600	60Hz	37.879kHz	40.000MHz	○
XGA	1024X768	60Hz	48.363kHz	65.000MHz	○
WXGA	1280X768	60Hz	47.776kHz	79.500MHz	○
	1360X768	60Hz	47.712kHz	85.500MHz	○
SXGA	1280X1024	60Hz	63.981kHz	108.000MHz	○
WQHD	2560X1440	60Hz	88.787kHz	241.500MHz	○

本機で再生できる 動画のフォーマット

対応機器	ファイルフォーマット	映像フォーマット	音声フォーマット	最大解像度	最大ファイル数
USB 機器	MPEG2-TS	MPEG2 Video	AAC、MPEG-1 Layer II	1920 × 1080	3000/フォルダ
	MPEG2-TS	H.264/MPEG4-AVC	AACドルビーデジタル (AC3)	1920 × 1080	3000/フォルダ
	MPEG2-TS	HEVC	AAC、HE-AAC ドルビーデジタル (AC3)	3840 × 2160	3000/フォルダ
	MPEG2-PS	MPEG2 Video	リニアPCM、 ドルビーデジタル (AC3)、 MPEG-1,2 Layer II	1920 × 1080	3000/フォルダ
	MP4	MPEG-4 Visual	AAC	1920 × 1080	3000/フォルダ
		HEVC	AAC、HE-AAC	3840 × 2160	3000/フォルダ
		H.264/MPEG4-AVC	AAC、HE-AAC、 リニアPCM	3840 × 2160	3000/フォルダ

- ※ H.264/MPEG4-AVC の 3840×2160 の場合、フレームレートは最大で 30fps までです。その他のフォーマットは 60fps まで対応しています。
- ※ 一部の動画は再生できないことがあります。特に MP4 動画については、対応機器によっては再生できないことがあります。
- ※ 音声がついていない映像だけの動画は再生できません。
- ※ 対応機器の性能によっては、映像が乱れたり、雑音が出たりするなど、正常に再生できないことがあります。

本機で再生できる写真（静止画ファイル）のフォーマット

圧縮方式	JPEG準拠
フォーマット	Exif ver2.2準拠、JFIF ver1.02準拠
画素数	16384 × 16384ピクセル以内
ファイルサイズ	USB機器についてはファイルサイズ24MB以内

- ※一部の写真は再生できない事があります。

アイコン一覧

番組についてのアイコン

アイコン	説明	アイコン	説明
ステレオ	ステレオ音声放送	〇〇才~	視聴年齢制限が設定されている番組。〇〇は4~20の数字が入ります。
サラウンド	サラウンドステレオ放送	契約済	有料放送で契約済のチャンネル。
二重音声	二重音声放送	未契約	有料放送で契約していないチャンネル。
HD:1080i	放送フォーマットが1080iのデジタルハイビジョン放送	ダビング	録画回数が制限されている番組。
HD:720i	放送フォーマットが720pのデジタルハイビジョン放送	デジタルコピー可	デジタル録画ができる番組。
SD:480i	放送フォーマットが480iのデジタル標準テレビ放送	デジタルコピー¥	有料でデジタル録画ができる番組。
SD:480p	放送フォーマットが480pのデジタル標準テレビ放送	デジタルコピー×	デジタル録画ができない番組。
字	字幕放送	光デジタルコピー可	光デジタル録音ができる番組。
4K:2160p	放送フォーマットが2160pの4K映像放送	光デジタルコピー1	1回だけ光デジタル録音ができる番組。
8K:4320p	放送フォーマットが4320pの8K映像放送	光デジタルコピー¥	有料で光デジタル録音ができる番組。
信号切換	複数の映像、または音声またはデータがある番組	光デジタルコピー×	光デジタル録音ができない番組。
PPV:〇〇円	PPV (ペイ・パー・ビュー) 番組。 〇〇は金額が入ります。		

●ダビング・コピー関係のアイコンの中には、本機の機能とは無関係に番組の情報として表示されるものがあります。

アイコン一覧

お知らせ、予約、その他についてのアイコン

アイコン	説明	アイコン	説明
	録画予約		連ドラ予約番組の追跡結果や放送時間変更で、有料番組の予約が重なったときなどに表示されます。
	連ドラ予約		視聴予約が重なったときに表示されます。
	視聴予約		録画番組が「保護」対象
	録画中		録画番組が「上書き」対象
	録画準備中 録画の約1分前に表示されます。		未読の「お知らせ」
	録画確認中 前番組の放送延長などで録画番組の放送時間が変更されたときなどに表示されます。		既読の「お知らせ」
	連ドラ予約番組の追跡結果や放送時間変更で、予約が重なったときなどに表示されます。		非リンク型サービス(通信番組) (P.27)

ライセンスおよび商標などについて



この製品はドルビーラボラトリーズからの実施権に基づき製造されています。Dolby、ドルビー、Dolby AudioおよびダブルD記号はドルビーラボラトリーの商標です。



本製品は、株式会社ACCESSのNetFront Browserを搭載しています。ACCESS、NetFrontは、日本国およびその他の国における株式会社ACCESSの商標または登録商標です。©2009 ACCESS CO.,LTD. All rights reserved



この製品はEilex International, LLCからの実施権に基づき製造されています。Eilex PRISM、VIR Filter、Eilex Focusは、Eilex International,LLCの商標です。

- トスリンクは株式会社東芝の登録商標です。
- Blu-ray Disc™ (ブルーレイディスク)、Blu-ray™ (ブルーレイ) はブルーレイディスクアソシエーションの商標です。
- その他、取扱説明書に記載されている社名・商品・サービス名などは、それぞれ各社が商標として使用している場合があります。
- この製品の一部分にIndependent JPEG Groupが開発したモジュールが含まれています。
- この製品に含まれているソフトウェアをリバース・エンジニアリング、逆アセンブル、逆コンパイル、分解またはその他の方法で解析、および変更することは禁止されています。

●AVC PATENT PORTFOLIO LICENSE

THIS PRODUCT IS LICENSED UNDER THE AVC PATENT PORTFOLIO LICENSE FOR THE PERSONAL AND NON COMMERCIAL USE OF A CONSUMER TO (i) ENCODE VIDEO IN COMPLIANCE WITH THE AVC STANDARD("AVC VIDEO") AND/OR (ii) DECODE AVC VIDEO THAT WAS ENCODED BY A CONSUMER ENGAGED IN A PERSONAL AND NON-COMERCIAL ACTIVITY AND/OR WAS OBTAINED FROM A VIDEO PROVIDER LICENSED PROVIDE AVC VIDEO. NO LICENSE ID GRANTED OR SHALL BE IMPLIED FOR ANY OTHER USE. ADDITIONAL INFORMATION MAY BE OBTAINED FROM MPEG LA,L.L.C. SEE [HTTP://WWW.MPEGLA.COM](http://www.mpegla.com)

● This product contains technology subject to certain intellectual property right of Microsoft. Use or distribution of this technology outside of this product is prohibited without the appropriate license(s) from Microsoft.

PlayReady end user notice

Content owners use Microsoft PlayReady™ content access technology to protect their intellectual property, including copyrighted content. This device uses PlayReady technology to access PlayReady-protected content and/or WMDRM-protected content. If the device fails to property enforce restrictions on content usage, content owners may require Microsoft to revoke the device's ability to consume PlayReady-protected content. Revocation should not affect unprotected content or content protected by other content access technologies. Content owners may require you to upgrade PlayReady to access their content. If you decline an upgrade, you will not be able to access content that requires the upgrade.

This product includes software developed by the OpenSSL Project for use in the OpenSSL Toolkit (<http://www.openssl.org/>)

This product has used the FreeType code.

本機で使われるソフトウェアライセンス情報

本機で使われるソフトウェアのライセンス情報

本機に組み込まれたソフトウェアは、複数の独立したソフトウェアコンポーネントで構成され、個々のソフトウェアコンポーネントは、それぞれに製品ソフト開発会社または第三者の著作権が存在します。

本機は、第三者が規定したエンドユーザーライセンスアグリーメントあるいは著作権通知（以下、「EULA」といいます）に基づきフリーソフトウェアとして配布されるソフトウェアコンポーネントを使用しております。

「EULA」の中には、実行形式のソフトウェアコンポーネントを配布する条件として、当該コンポーネントのソースコードの入手を可能にするよう求めているものがあります。当該「EULA」の対象となるソフトウェアコンポーネントに関しては、対応ソフトウェアモジュールをご覧いただくようお願いいたします。

また、本機のソフトウェアコンポーネントには、製品ソフト開発会社が開発もしくは作成したソフトウェアも含まれており、これらソフトウェア及びそれに付帯したドキュメント類には、製品ソフト開発会社の所有権が存在し、著作権法、国際条約条項及び他の準拠法によって保護されています。「EULA」の適用を受けない製品ソフト開発会社自身が開発もしくは作成したソフトウェアコンポーネントは、ソースコード提供の対象とはなりませんのでご了承ください。

ご購入いただいた本機は、製品として、弊社所定の保証をいたします。

ただし、「EULA」に基づいて配布されるソフトウェアコンポーネントには、著作権者または弊社を含む第三者の保証がないことを前提に、お客様がご自身でご利用になられることが認められるものがあります。この場合、当該ソフトウェアコンポーネントは無償でお客様に使用許諾されますので、適用法令の範囲内で、当該ソフトウェアコンポーネントの保証は一切ありません。著作権やその他の第三者の権利等については、一切の保証がなく、「as is」（現状）の状態です。かつ、明示か黙示であるかを問わず一切の保証をつけず、当該ソフトウェアコンポーネントが提供されます。ここでいう保証とは、市場性や特定目的適合性についての黙示の保証も含まれますが、それに限定されるものではありません。当該ソフトウェアコンポーネントの品質や性能に関するすべてのリスクはお客様が負うものとします。また、当該ソフトウェアコンポーネントに欠陥があるとわかった場合、それに伴う一切の派生費用や修理・訂正に要する費用は、製品ソフト開発会社は一切の責任を負いません。適用法令の定め、又は書面による合意がある場合を除き、著作権者や上記許諾を受けて当該ソフトウェアコンポーネントの変更・再配布を為し得る者は、当該ソフトウェアコンポーネントを使用したこと、又は使用できないことに起因する一切の損害についてなんらの責任も負いません。著作権者や第三者が、そのような損害の発生する可能性について知らされていた場合でも同様です。なお、ここでいう損害には、通常損害、特別損害、偶発損害、間接損害が含まれます（データの消失、又はその正確さの喪失、お客様や第三者が被った損失、他のソフトウェアとのインターフェースの不適合化等も含まれますが、これに限定されるものではありません）。当該ソフトウェアコンポーネントの使用条件や遵守いただかなければならない事項等の詳細は、各「EULA」をお読みください。

本機に組み込まれた「EULA」の対象となるソフトウェアコンポーネントは、以下のとおりです。

これらのソフトウェアコンポーネントをお客様自身でご利用いただく場合は、対応する「EULA」をよく読んでから、ご利用くださるようお願いいたします。なお、各「EULA」は、製品ソフト開発会社以外の第三者による規定であるため、原文（英文）を記載します。

対応ソフトウェアモジュール

Exhibit (A) - Linux Kernel, xfsprogs, parted, BUSY BOX, util-linux, bluez, dbus, sbc, sgdisk
Exhibit (B) - samba, mount.cifs, iptables
Exhibit (C) - u-boot, Wireless Tools
Exhibit (D) - directfb, GLIBC, libgcrypt, LVM2, libnl, ALSA
Exhibit (E) - libwebsockets, libgpg-error, dbus-c++, cryptsetup, ffmpeg
Exhibit (F) - libupnp
Exhibit (G) - WIDE-DHCPv6
Exhibit (H) - jQuery

Exhibit (I) - fuse, glib
Exhibit (J) - libsoap
Exhibit (K) - FreeType
Exhibit (L) - OpenSSL
Exhibit (M) - mongoose
Exhibit (N) - wpa_supplicant, hostapd
Exhibit (O) - dtoa
Exhibit (P) - cJSON
Exhibit (Q) - expat
Exhibit (R) - popt
Exhibit (S) - jQuery UI
Exhibit (T) - Backbone.js
Exhibit (U) - Underscore.js

Exhibit (V) - MALI GPUS LINUX KERNEL DEVICE DRIVERS
Exhibit (W) - libxml2
Exhibit (X) - libpng
Exhibit (Y) - zlib
Exhibit (Z) - libevent
Exhibit (a) - libffi
Exhibit (b) - Mithril.js
Exhibit (c) - webpack
Exhibit (d) - FreeRTOS
Exhibit (e) - NetFront BE, NetFront NX
Exhibit (f) - tftp-hpa
Exhibit (g) - Bluedroid, google-cloud-cpp, gRPC
Exhibit (h) - btmtk_usb

Exhibit (A)

GNU GENERAL PUBLIC LICENSE Version 2, June 1991

Copyright (C) 1989, 1991 Free Software Foundation, Inc.
51 Franklin St, Fifth Floor, Boston, MA 02110-1301 USA
Everyone is permitted to copy and distribute verbatim copies of this license document, but changing it is not allowed.

Preamble

The licenses for most software are designed to take away your freedom to share and change it. By contrast, the GNU General Public License is intended to guarantee your freedom to share and change free software—to make sure the software is free for all its users. This General Public License applies to most of the Free Software Foundation's software and to any other program whose authors commit to using it. (Some other Free Software Foundation software is covered by the GNU Library General Public License instead.) You can apply it to your programs, too.

When we speak of free software, we are referring to freedom, not price. Our General Public Licenses are designed to make sure that you have the freedom to distribute copies of free software (and charge for this service if you wish), that you receive source code or can get it if you want it, that you can change the software or use pieces of it in new free programs; and that you know you can do these things.

To protect your rights, we need to make restrictions that forbid anyone to deny you these rights or to ask you to surrender the rights. These restrictions translate to certain responsibilities for you if you distribute copies of the software, or if you modify it.

For example, if you distribute copies of such a program, whether gratis or for a fee, you must give the recipients all the rights that you have. You must make sure that they, too, receive or can get the source code. And you must show them these terms so they know their rights.

We protect your rights with two steps: (1) copyright the software, and (2) offer you this license which gives you legal permission to copy, distribute and/or modify the software.

Also, for each author's protection and ours, we want to make certain that everyone understands that there is no warranty for this free software. If the software is modified by someone else and passed on, we want its recipients to know that what they have is not the original, so that any problems introduced by others will not reflect on the original authors' reputations.

Finally, any free program is threatened constantly by software patents. We wish to avoid the danger that redistributors of a free program will individually obtain patent licenses, in effect making the program proprietary. To prevent this, we have made it clear that any patent must be licensed for everyone's free use or not licensed at all.

The precise terms and conditions for copying, distribution and modification follow.

GNU GENERAL PUBLIC LICENSE TERMS AND CONDITIONS FOR COPYING, DISTRIBUTION AND MODIFICATION

0. This License applies to any program or other work which contains a notice placed by the copyright holder saying it may be distributed under the terms of this General Public License. The "Program", below, refers to any such program or work and a "work based on the Program" means either the Program or any derivative work under copyright law; that is to say, a work containing the Program or a portion of it, either verbatim or with modifications and/or translated into another language. (Hereinafter, translation is included without limitation in the term "modification".) Each licensee is addressed as "you".

Activities other than copying, distribution and modification are not covered by this License; they are outside its scope. The act of running the Program is not restricted, and the output from the Program is covered only if its contents constitute a work based on the Program (independent of having been made by running the Program). Whether that is true depends on what the Program does.

1. You may copy and distribute verbatim copies of the Program's source code as you receive it, in any medium, provided that you conspicuously and appropriately publish on each copy an appropriate copyright notice and disclaimer of warranty; keep intact all the notices that refer to this License and to the absence of any warranty; and give any other recipients of the Program a copy of this License along with the Program. You may charge a fee for the physical act of transferring a copy, and you may also offer warranty protection in exchange for a fee.

2. You may modify your copy or copies of the Program or any portion of it, thus forming a work based on the Program, and copy and distribute such modifications or work under the terms of Section 1 above, provided that you also meet all of these conditions:

a) You must cause the modified files to carry prominent notices stating that you changed the files and the date of any change.

b) You must cause any work that you distribute or publish, that in whole or in part contains or is derived from the Program or any part thereof, to be licensed as a whole at no charge to all third parties under the terms of this License.

c) If the modified program normally reads commands interactively when run, you must cause it, when started running for such interactive use, to display the notice and a notice that there is no warranty (or else, saying that you provide a warranty) and that users may redistribute the program under these conditions, and telling of the user how to view a copy of this License. (Exception: if the Program itself is interactive but does not normally print such an announcement, your work based on the Program is not required to print an announcement.)

These requirements apply to the modified work as a whole. If identifiable sections of that work are not derived from the Program, and can be reasonably considered independent and separate works in themselves, then this License, and its terms, do not apply to those sections when you distribute them as separate works. But when you distribute the same sections as part of a whole which is a work based on the Program, the distribution of the whole must be on the terms of this License, whose permissions for other licensees extend to the entire whole, and thus to each and every part regardless of who wrote it.

Thus, it is not the intent of this section to claim rights or contest your rights to work written entirely by you; rather, the intent is to exercise the right to control the distribution of derivative or collective works based on the Program.

In addition, mere aggregation of another work not based on the Program with the Program (or with a work based on the Program) on a volume of a storage or distribution medium does not bring the other work under the scope of this License.

3. You may copy, copy and distribute the Program (or a work based on it, under Section 2) in object code or executable form under the terms of Sections 1 and 2 above provided that you also do one of the following:

a) Accompany it with the complete corresponding machine-readable source code, which must be distributed under the terms of Sections 1 and 2 above on a medium customarily used for software interchange; or,

b) Accompany it with a written offer, valid for at least three years, to give any third party, for a charge no more than your cost of physically performing source distribution, a complete machine-readable copy of the corresponding source code, to be distributed under the terms of Sections 1 and 2 above on a medium customarily used for software interchange; or,

c) Accompany it with the information you received as to the offer to distribute corresponding source code. (This alternative is allowed only for noncommercial distribution and only if you received the program in object code or executable form with such an offer, in accord with Subsection b above.)

The source code for a work means the preferred form of the work for making modifications to it. For an executable work, complete source code means all the source code for all modules it contains, plus any associated interface definition files, plus the scripts used to control compilation and installation of the executable. However, as a special exception, the source code distributed need not include anything that is normally distributed (in either source or binary form) with the major components (compiler, kernel, and so on) of the operating system on which the executable runs, unless that component itself accompanies the executable.

If distribution of executable or object code is made by offering access to copy from a designated place, then offering equivalent access to copy the source code from the same place counts as

distribution of the source code, even though third parties are not compelled to copy the source along with the object code.

4. You may not copy, modify, sublicense, or distribute the Program except as expressly provided under this License. Any attempt otherwise to copy, modify, sublicense or distribute the Program is void, and will automatically terminate your rights under this License. However, parties who have received copies, or rights, from you under this License will not have their licenses terminated so long as such parties remain in full compliance.

5. You are not required to accept this License, since you have not signed it. However, nothing else grants you permission to modify or distribute the Program or its derivative works. These actions are prohibited by law if you do not accept this License. Therefore, by modifying or distributing the Program (or any work based on the Program), you indicate your acceptance of this License to do so, and all its terms and conditions for copying, distributing or modifying the Program or works based on it.

6. Each time you redistribute the Program (or any work based on the Program), the recipient automatically receives a license from the original licensor to copy, distribute or modify the Program subject to these terms and conditions. You may not impose any further restrictions on the recipients' exercise of the rights granted herein. You are not responsible for enforcing compliance by third parties with this License.

7. If, as a consequence of a court judgment or allegation of patent infringement or for any other reason (not limited to patent issues), conditions are imposed on you (whether by court order, agreement or otherwise) that contradict the conditions of this License, they do not excuse you from the conditions of this License. If you cannot distribute so as to satisfy simultaneously your obligations under this License and any other pertinent obligations, then as a consequence you may not distribute the Program at all. For example, if a patent license would not permit royalty-free redistribution of the Program by all those who receive copies directly or indirectly through you, then the only way you could satisfy both it and this License would be to refrain entirely from distribution of the Program.

If any portion of this section is held invalid or unenforceable under any particular circumstance, the balance of the section is intended to apply and the section as a whole is intended to apply in other circumstances.

It is not the purpose of this section to induce you to infringe any patents or other property right claims or to contest validity of any such claims; this section has the sole purpose of protecting the integrity of the free software distribution system, which is implemented by public license practices. Many people have made generous contributions to the wide range of software distributed through that system in reliance on consistent application of that system; it is up to the author/donor to decide if he or she is willing to distribute software through any other system and a licensee cannot impose that choice.

This section is intended to make thoroughly clear what is believed to be a consequence of the rest of this License.

8. If the distribution and/or use of the Program is restricted in certain countries either by patents or by copyrighted interfaces, the original copyright holder who places the Program under this License may add an explicit geographical distribution limitation excluding those countries, so that distribution is permitted only in or among countries not thus excluded. In such case, this License incorporates the limitation as if written in the body of this License.

9. The Free Software Foundation may publish revised and/or new versions of the General Public License from time to time. Such new versions will be similar in spirit to the present version, but may differ in detail to address new problems or concerns. Each version is given a distinguishing version number. If the Program specifies a version number of this License which applies to it and "any later version", you have the option of following the terms and conditions either of that version or of any later version published by the Free Software Foundation. If the Program does not specify a version number of this License, you may choose any version ever published by the Free Software Foundation.

10. If you wish to incorporate parts of the Program into other free programs whose distribution conditions are different, write to the author to ask for permission. For software which is copyrighted by the Free Software Foundation, write to the Free Software Foundation; we sometimes make exceptions for this. Our decision will be guided by the two goals of preserving the free status of all derivatives of our free software and of promoting the sharing and reuse of software generally.

NO WARRANTY

11. BECAUSE THE PROGRAM IS LICENSED FREE OF CHARGE, THERE IS NO WARRANTY FOR THE PROGRAM, TO THE EXTENT PERMITTED BY APPLICABLE LAW. EXCEPT WHEN OTHERWISE STATED IN WRITING THE COPYRIGHT HOLDERS AND/OR OTHER PARTIES PROVIDE THE PROGRAM "AS IS" WITHOUT WARRANTY OF ANY KIND, EITHER EXPRESSED OR IMPLIED, INCLUDING, BUT NOT LIMITED TO, THE IMPLIED WARRANTIES OF MERCHANTABILITY AND FITNESS FOR A PARTICULAR PURPOSE. THE ENTIRE RISK AS TO THE QUALITY AND PERFORMANCE OF THE PROGRAM IS WITH YOU. SHOULD THE PROGRAM PROVE DEFECTIVE, YOU ASSUME THE COST OF ALL NECESSARY SERVICING, REPAIR OR CORRECTION.

12. IN NO EVENT UNLESS REQUIRED BY APPLICABLE LAW OR AGREED TO IN WRITING WILL ANY COPYRIGHT HOLDER, OR ANY OTHER PARTY WHO MAY MODIFY AND/OR REDISTRIBUTE THE PROGRAM AS PERMITTED ABOVE, BE LIABLE TO YOU FOR DAMAGES, INCLUDING ANY GENERAL, SPECIAL, INCIDENTAL OR CONSEQUENTIAL DAMAGES ARISING OUT OF THE USE OR INABILITY TO USE THE PROGRAM (INCLUDING BUT NOT LIMITED TO LOSS OF DATA OR DATA BEING RENDERED INACCURATE OR LOSSES SUSTAINED BY YOU OR THIRD PARTIES OR A FAILURE OF THE PROGRAM TO OPERATE WITH ANY OTHER PROGRAMS), EVEN IF SUCH HOLDER OR OTHER PARTY HAS BEEN ADVISED OF THE POSSIBILITY OF SUCH DAMAGES.

END OF TERMS AND CONDITIONS

How to Apply These Terms to Your New Programs

If you develop a new program, and you want it to be of the greatest possible use to the public, the best way to achieve this is to make it free software which everyone can redistribute and change under these terms.

To do so, attach the following notices to the program. It is safest to attach them to the start of each source file to most effectively convey the exclusion of warranty; and each file should have at least the "copyright" line and a pointer to where the full notice is found.

<one line to give the program's name and a brief idea of what it does.>
Copyright (C) <year> <name of author>

This program is free software; you can redistribute it and/or modify it under the terms of the GNU General Public License as published by the Free Software Foundation; either version 2 of the License, or (at your option) any later version.

This program is distributed in the hope that it will be useful, but WITHOUT ANY WARRANTY; without even the implied warranty of MERCHANTABILITY or FITNESS FOR A PARTICULAR PURPOSE. See the GNU General Public License for more details.

You should have received a copy of the GNU General Public License along with this program; if not, write to the Free Software Foundation, Inc., 51 Franklin St, Fifth Floor, Boston, MA 02110-1301 USA

Also add information on how to contact you by electronic and paper mail.

If the program is interactive, make it output a short notice like this when it starts in an interactive mode:

Gnomovision version 69, Copyright (C) year name of author Gnomovision comes with ABSOLUTELY NO WARRANTY; for details type 'show w'. This is free software, and you are welcome to redistribute it under certain conditions; type 'show c' for details.

The hypothetical commands 'show w' and 'show c' should show the appropriate parts of the General Public License. Of course, the commands you use may be called something other than 'show w' and 'show c'; they could even be mouse-clicks or menu items—whatever suits your program.

You should also get your employer (if you work as a programmer) or your school, if any, to sign a "copyright disclaimer" for the program, if necessary. Here is a sample; alter the names:

Yoyodyne, Inc., hereby disclaims all copyright interest in the program 'Gnomovision' (which makes passes at compilers) written by James Hacker.

<signature of Ty Coon>, 1 April 1989
Ty Coon, President of Vice

This General Public License does not permit incorporating your program into proprietary programs. If your program is a subroutine library, you may consider it more useful to permit linking proprietary applications with the library. If this is what you want to do, use the GNU Library General Public License instead of this License.

本機で使われるソフトウェアライセンス情報 (つづき)

Exhibit (B)

GNU GENERAL PUBLIC LICENSE Version 2, June 1991

Copyright (C) 1989, 1991 Free Software Foundation, Inc.
675 Mass Ave, Cambridge, MA 02139, USA
Everyone is permitted to copy and distribute verbatim copies of this license document, but changing it is not allowed.

Preamble

The licenses for most software are designed to take away your freedom to share and change it. By contrast, the GNU General Public License is intended to guarantee your freedom to share and change free software--to make sure the software is free for all its users. This General Public License applies to most of the Free Software Foundation's software and to any other program whose authors commit to using it. (Some other Free Software Foundation software is covered by the GNU Library General Public License instead.) You can apply it to your programs, too.

When we speak of free software, we are referring to freedom, not price. Our General Public Licenses are designed to make sure that you have the freedom to distribute copies of free software (and charge for this service if you wish), that you receive source code or can get it if you want it, that you can change the software or use pieces of it in new free programs; and that you know you can do these things.

To protect your rights, we need to make restrictions that forbid anyone to deny you these rights or to ask you to surrender the rights. These restrictions translate to certain responsibilities for you if you distribute copies of the software, or if you modify it.

For example, if you distribute copies of such a program, whether gratis or for a fee, you must give the recipients all the rights that you have. You must make sure that they, too, receive or can get the source code. And you must show them these terms so they know their rights.

We protect your rights with two steps: (1) copyright the software, and (2) offer you this license which gives you legal permission to copy, distribute and/or modify the software.

Also, for each author's protection and ours, we want to make certain that everyone understands that there is no warranty for this free software. If the software is modified by someone else and passed on, we want its recipients to know that what they have is not the original, so that any problems introduced by others will not reflect on the original authors' reputations.

Finally, any free program is threatened constantly by software patents. We wish to avoid the danger that redistributors of a free program will individually obtain patent licenses, in effect making the program proprietary. To prevent this, we have made it clear that any patent must be licensed for everyone's free use or not licensed at all.

The precise terms and conditions for copying, distribution and modification follow.

GNU GENERAL PUBLIC LICENSE TERMS AND CONDITIONS FOR COPYING, DISTRIBUTION AND MODIFICATION

0. This License applies to any program or other work which contains a notice placed by the copyright holder stating it may be distributed under the terms of this General Public License. The "program", below, refers to any such program or work and a "work based on the Program" means either the Program or any derivative work under copyright law; that is to say, a work containing the Program or a portion of it, either verbatim or with modifications and/or translated into another language. (Hereinafter, translation is included without limitation in the term "modification".) Each licensee is addressed as "you".

Activities other than copying, distribution and modification are not covered by this License; they are outside its scope. The act of running the Program is not restricted, and the output from the Program is covered only if its contents constitute a work based on the Program (independent of having been made by running the Program). Whether that is true depends on what the Program does.

1. You may copy and distribute verbatim copies of the Program's source code as you receive it, in any medium, provided that you conspicuously and appropriately publish on each copy an appropriate copyright notice and disclaimer of warranty; keep intact all the notices that refer to this License and to the absence of any warranty; and give any other recipients of the Program a copy of this License along with the Program. You may charge a fee for the physical act of transferring a copy, and you may at your option offer warranty protection in exchange for a fee.

2. You may modify your copy or copies of the Program or any portion of it, thus forming a work based on the Program, and copy and distribute such modifications or work under the terms of Section 1 above, provided that you also meet all of these conditions:

- You must cause the modified files to carry prominent notices stating that you changed the files and the date of any change.
- You must cause any work that you distribute or publish, that in whole or in part contains or is derived from the Program or any part thereof, to be licensed as a whole to all third parties under the terms of this License.

c) If the modified program normally reads commands interactively when run, you must cause it, when started running for such interactive use in the most ordinary way, to print or display an announcement including an appropriate copyright notice and a notice that there is no warranty (or else, saying that you provide a warranty) and that users may redistribute the program under these conditions, and telling the user how to view a copy of this license. (Exception: if the program itself is interactive but does not normally print such an announcement, your work based on the Program is not required to print an announcement.)

These requirements apply to the modified work as a whole. If identifiable sections of that work are not derived from the Program, and can be reasonably considered independent and separate works in themselves, then this License, and its terms, do not apply to those sections when you distribute them as separate works. But when you distribute the same sections as part of a whole which is a work based on the Program, the distribution of the whole must be on the terms of this License, whose permissions for other licensees extend to the entire whole, and thus to each and every part regardless of who wrote it. Thus, it is not the intent of this section to claim rights or contest your rights to work written entirely by you; rather, the intent is to exercise the right to control the distribution of derivative or collective works based on the Program. In addition, mere aggregation of another work not based on the Program with the Program (or with a work based on the Program) on a volume of a storage or distribution medium does not bring the other work under the scope of this License.

3. You may copy and distribute the Program (or a work based on it, under Section 2) in object code or executable form under the terms of Sections 1 and 2 above provided that you also do one of the following:

- Accompany it with the complete corresponding machine-readable source code, which must be distributed under the terms of Sections 1 and 2 above on a medium customarily used for software interchange; or,
- Accompany it with a written offer, valid for at least three years, to give any third party, for a charge no more than your cost of physically performing source distribution, a complete machine-readable copy of the corresponding source code, to be distributed under the terms of Sections 1 and 2 above on a medium customarily used for software interchange; or,
- Accompany it with the information you received as to the offer to distribute corresponding source code. (This alternative is allowed only for noncommercial distribution and only if you received the program in object code or executable form with such an offer, in accord with Subsection b above.)

The source code for a work means the preferred form of the work for making modifications to it. For an executable work, complete source code means all the source code for all modules it contains, plus any associated interface definition files, plus the scripts used to control compilation and installation of the executable. However, as a special exception, the source code distributed need not include anything that is normally distributed (in either source or binary form) with the major components (compiler, kernel, and so on) of the operating system on which the executable runs, unless that component itself accompanies the executable.

If distribution of executable or object code is made by offering access to copy from a designated place, then offering equivalent access to copy the source code from the same place counts as distribution of the source code, even though third parties are not compelled to copy the source along with the object code.

4. You may not copy, modify, sublicense, or distribute the Program except as expressly provided under this License. Any attempt otherwise to copy, modify, sublicense or distribute the Program is void, and will automatically terminate your rights under this License. However, parties who have received copies, or rights, from you under this License will not have their licenses terminated so long as such parties remain in full compliance.

5. You are not required to accept this License, since you have not signed it. However, nothing else grants you permission to modify or distribute the Program or its derivative works. These actions are prohibited by law if you do not accept this License. Therefore, by modifying or distributing the Program (or any work based on the Program), you indicate your acceptance of this License to do so, and all its terms and conditions for copying, distributing or modifying the Program or works based on it.

6. Each time you redistribute the Program (or any work based on the Program), the recipient automatically receives a license from the original licensor to copy, distribute or modify the Program subject to these terms and conditions. You may not impose any further restrictions on the recipients' exercise of the rights granted herein. You are not responsible for enforcing compliance by third parties with this License.

7. If, as a consequence of a court judgment or allegation of patent infringement or for any other reason (not limited to patent issues), conditions are imposed on you (whether by court order, agreement or otherwise) that contradict the conditions of this License, they do not excuse you from the conditions of this License. If you cannot distribute so as to satisfy simultaneously your obligations under this License and any other pertinent obligations, then as a consequence you may not distribute the Program at all. For example, if a patent license would not permit royalty-free redistribution of the Program by all those who receive copies directly or indirectly through you, then the only way you could satisfy both it and this License would be to refrain entirely from distribution of the Program. If any portion of this section is held invalid or unenforceable under any particular circumstance, the balance of the section is intended to apply and the section as a whole is intended to apply in other circumstances. It is not the purpose of this section to induce you to infringe any patents or other property right claims or to contest validity of any such claims; this section has the sole purpose of protecting the integrity of the free software distribution system, which is implemented by public license practices. Many people have made generous contributions to the wide range of software distributed through that system in reliance on consistent application of that system; it is up to the author/donor to decide if he or she is willing to distribute software through any other system and a licensee cannot impose that choice. This section is intended to make thoroughly clear what is believed to be a consequence of the rest of this License.

8. If the distribution and/or use of the Program is restricted in certain countries either by patents or by copyrighted interfaces, the original copyright holder who places the Program under this License may add an explicit geographical distribution limitation excluding those countries, so that distribution is permitted only in or among countries not thus excluded. In such case, this License incorporates the limitation as if written in the body of this License.

9. The Free Software Foundation may publish revised and/or new versions of the General Public License from time to time. Such new versions will be similar in spirit to the present version, but may differ in detail to address new problems or concerns. Each version is given a distinguishing version number. If the Program specifies a version number of this License which applies to it and "any later version", you have the option of following the terms and conditions either of that version or of any later version published by the Free Software Foundation. If the Program does not specify a version number of this License, you may choose any version ever published by the Free Software Foundation.

10. If you wish to incorporate parts of the Program into other free programs whose distribution conditions are different, write to the author to ask for permission. For software which is copyrighted by the Free Software Foundation, write to the Free Software Foundation; we sometimes make exceptions for this. Our decision will be guided by the two goals of preserving the free status of all derivatives of our free software and of promoting the sharing and reuse of software generally.

NO WARRANTY

11. BECAUSE THE PROGRAM IS LICENSED FREE OF CHARGE, THERE IS NO WARRANTY FOR THE PROGRAM, TO THE EXTENT PERMITTED BY APPLICABLE LAW. EXCEPT WHEN OTHERWISE STATED IN WRITING THE COPYRIGHT HOLDERS AND/OR OTHER PARTIES PROVIDE THE PROGRAM "AS IS" WITHOUT WARRANTY OF ANY KIND, EITHER EXPRESSED OR IMPLIED, INCLUDING, BUT NOT LIMITED TO, THE IMPLIED WARRANTIES OF MERCHANTABILITY AND FITNESS FOR A PARTICULAR PURPOSE. THE ENTIRE RISK AS TO THE QUALITY AND PERFORMANCE OF THE PROGRAM IS WITH YOU. SHOULD THE PROGRAM PROVE DEFECTIVE, YOU ASSUME THE COST OF ALL NECESSARY SERVICING, REPAIR OR CORRECTION.

12. IN NO EVENT UNLESS REQUIRED BY APPLICABLE LAW OR AGREED TO IN WRITING WILL ANY COPYRIGHT HOLDER, OR ANY OTHER PARTY WHO MAY MODIFY AND/OR REDISTRIBUTE THE PROGRAM AS PERMITTED ABOVE, BE LIABLE TO YOU FOR DAMAGES, INCLUDING ANY GENERAL, SPECIAL, INCIDENTAL OR CONSEQUENTIAL DAMAGES ARISING OUT OF THE USE OR INABILITY TO USE THE PROGRAM (INCLUDING BUT NOT LIMITED TO LOSS OF DATA OR DATA BEING RENDERED INACCURATE OR LOSSES SUSTAINED BY YOU OR THIRD PARTIES OR A FAILURE OF THE PROGRAM TO OPERATE WITH ANY OTHER PROGRAMS), EVEN IF SUCH HOLDER OR OTHER PARTY HAS BEEN ADVISED OF THE POSSIBILITY OF SUCH DAMAGES.

END OF TERMS AND CONDITIONS

Appendix: How to Apply These Terms to Your New Programs

If you develop a new program, and you want it to be of the greatest possible use to the public, the best way to achieve this is to make it free software which everyone can redistribute and change under these terms.

To do so, attach the following notices to the program. It is safest to attach them to the start of each source file to most effectively convey the exclusion of warranty; and each file should have at least the "copyright" line and a pointer to where the full notice is found.

<one line to give the program's name and a brief idea of what it does.>
Copyright (C) 19yy <name of author>

This program is free software; you can redistribute it and/or modify it under the terms of the GNU General Public License as published by the Free Software Foundation; either version 2 of the License, or (at your option) any later version.

This program is distributed in the hope that it will be useful, but WITHOUT ANY WARRANTY; without even the implied warranty of MERCHANTABILITY or FITNESS FOR A PARTICULAR PURPOSE. See the GNU General Public License for more details.

You should have received a copy of the GNU General Public License along with this program; if not, write to the Free Software Foundation, Inc., 675 Mass Ave, Cambridge, MA 02139, USA.

Also add information on how to contact you by electronic and paper mail.

If the program is interactive, make it output a short notice like this when it starts in an interactive mode:

Gnomovision version 69, Copyright (C) 19yy name of author
Gnomovision comes with ABSOLUTELY NO WARRANTY; for details type `show w'. This is free software, and you are welcome to redistribute it under certain conditions; type `show c' for details.

The hypothetical commands `show w' and `show c' should show the appropriate parts of the General Public License. Of course, the commands you use may be called something other than `show w' and `show c'; they could even be mouse-clicks or menu items--whatever suits your program.

You should also get your employer (if you work as a programmer) or your school, if any, to sign a "copyright disclaimer" for the program, if necessary. Here is a sample; alter the names:

Yooyodine, Inc., hereby disclaims all copyright interest in the program Gnomovision' (which makes passes at compilers) written by James Hacker.

<signature of Ty Coon>, 1 April 1989
Ty Coon, President of Vice

This General Public License does not permit incorporating your program into proprietary programs. If your program is a subroutine library, you may consider it more useful to permit linking proprietary applications with the library. If this is what you want to do, use the GNU Library General Public License instead of this License.

Exhibit (C)

GNU GENERAL PUBLIC LICENSE Version 2, June 1991

Copyright (C) 1989, 1991 Free Software Foundation, Inc.,
59 Temple Place, Suite 330, Boston, MA 02111-1307 USA
Everyone is permitted to copy and distribute verbatim copies of this license document, but changing it is not allowed.

Preamble

The licenses for most software are designed to take away your freedom to share and change it. By contrast, the GNU General Public License is intended to guarantee your freedom to share and change free software—to make sure the software is free for all its users. This General Public License applies to most of the Free Software Foundation's software and to any other program whose authors commit to using it. (Some other Free Software Foundation software is covered by the GNU Library General Public License instead.) You can apply it to your programs, too.

When we speak of free software, we are referring to freedom, not price. Our General Public Licenses are designed to make sure that you have the freedom to distribute copies of free software (and charge for this service if you wish), that you receive source code or can get it if you want it, that you can change the software or use pieces of it in new free programs; and that you know you can do these things.

To protect your rights, we need to make restrictions that forbid anyone to deny you these rights or to ask you to surrender the rights. These restrictions translate to certain responsibilities for you if you distribute copies of the software, or if you modify it.

For example, if you distribute copies of such a program, whether gratis or for a fee, you must give the recipients all the rights that you have. You must make sure that they, too, receive or can get the source code. And you must show them these terms so they know their rights.

We protect your rights with two steps: (1) copyright the software, and (2) offer you this license which gives you legal permission to copy, distribute and/or modify the software.

Also, for each author's protection and ours, we want to make certain that everyone understands that there is no warranty for this free software. If the software is modified by someone else and passed on, we want its recipients to know that what they have is not the original, so that any problems introduced by others will not reflect on the original authors' reputations.

Finally, any free program is threatened constantly by software patents. We wish to avoid the danger that redistributors of a free program will individually obtain patent licenses, in effect making the program proprietary. To prevent this, we have made it clear that any patent must be licensed for everyone's free use or not licensed at all.

The precise terms and conditions for copying, distribution and modification follow.

GNU GENERAL PUBLIC LICENSE TERMS AND CONDITIONS FOR COPYING, DISTRIBUTION AND MODIFICATION

0. This license applies to any program or other work which contains a notice placed by the copyright holder saying it may be distributed under the terms of this General Public License. The "Program" below, refers to any such program or work, and a "work based on the Program" means either the Program or any derivative work under copyright law: that is to say, a work containing the Program or a portion of it, either verbatim or with modifications and/or translated into another language. (Hereinafter, translation is included without limitation in the term "modification".) Each licensee is addressed as "you".

Activities other than copying, distribution and modification are not covered by this License; they are outside its scope. The act of running the Program is not restricted, and the output from the Program is covered only if its contents constitute a work based on the Program (independent of having been made by running the Program). Whether that is true depends on what the Program does.

1. You may copy and distribute verbatim copies of the Program's source code as you receive it, in any medium, provided that you conspicuously and appropriately publish on each copy an appropriate copyright notice and disclaimer of warranty; keep intact all the notices that refer to this License and to the absence of any warranty; and give any other recipients of the Program a copy of this License along with the Program.

You may charge a fee for the physical act of transferring a copy, and you may at your option offer warranty protection in exchange for a fee.

2. You may modify your copy or copies of the Program or any portion of it, thus forming a work based on the Program, and copy and distribute such modifications or work under the terms of Section 1 above, provided that you also meet all of these conditions:

a) You must cause the modified files to carry prominent notices stating that you changed the files and the date of any change.

b) You must cause any work that you distribute or publish, that in whole or in part contains or is derived from the Program or any part thereof, to be licensed as a whole at no charge to all third parties under the terms of this License.

c) If the modified program normally reads commands interactively when run, you must cause it, when started running for such interactive use in the most ordinary way, to print or display an announcement including an appropriate copyright notice and a notice that there is no warranty (or else, saying that you provide a warranty) and that users may redistribute the program under these conditions, and telling the user how to view a copy of this License. (Exception: if the Program itself is interactive but does not normally print such an announcement, your work based on the Program is not required to print an announcement.)

These requirements apply to the modified work as a whole. If identifiable sections of that work are not derived from the Program, and can be reasonably considered independent and separate works in themselves, then this License, and its terms, do not apply to those sections when you distribute them as separate works. But when you distribute the same sections as part of a whole which is a work based on the Program, the distribution of the whole must be on the terms of this License, whose permissions for other licensees extend to the entire whole, and thus to each and every part regardless of who wrote it.

Thus, it is not the intent of this section to claim rights or contest your rights to work written entirely by you; rather, the intent is to exercise the right to control the distribution of derivative or collective works based on the Program.

In addition, mere aggregation of another work not based on the Program with the Program (or with a work based on the Program) on a volume of a storage or distribution medium does not bring the other work under the scope of this License.

3. You may copy and distribute the Program (or a work based on it, under Section 2) in object code or executable form under the terms of Sections 1 and 2 above provided that you also do one of the following:

a) Accompany it with the complete corresponding machine-readable source code, which must be distributed under the terms of Sections 1 and 2 above on a medium customarily used for software interchange; or,

b) Accompany it with a written offer, valid for at least three years, to give any third party, for a charge no more than your cost of physically performing source distribution, a complete machine-readable copy of the corresponding source code, to be distributed under the terms of Sections 1 and 2 above on a medium customarily used for software interchange; or,

c) Accompany it with the information you received as to the offer to distribute corresponding source code. (This alternative is allowed only for noncommercial distribution and only if you received the program in object code or executable form with such an offer, in accord with Subsection b above.)

The source code for a work means the preferred form of the work for making modifications to it. For an executable work, complete source code means all the source code for all modules it contains, plus any associated interface definition files, plus the scripts used to control compilation and installation of the executable. However, as a special exception, the source code distributed need not include anything that is normally distributed (in either source or binary form) with the major components (compiler, kernel, and so on) of the operating system on which the executable runs, unless that component itself accompanies the executable.

If distribution of executable or object code is made by offering access to copy from a designated place, then offering equivalent access to copy the source code from the same place counts as distribution of the source code, even though third parties are not compelled to copy the source along with the object code.

4. You may not copy, modify, sublicense, or distribute the Program except as expressly provided under this License. Any attempt otherwise to copy, modify, sublicense or distribute the Program is void, and will automatically terminate your rights under this License. However, parties who have received copies, or rights, from you under this License will not have their licenses terminated so long as such parties remain in full compliance.

5. You are not required to accept this License, since you have not signed it. However, nothing else grants you permission to modify or distribute the Program or its derivative works. These actions are prohibited by law if you do not accept this License. Therefore, by modifying or distributing the Program (or any work based on the Program), you indicate your acceptance of this License to do so, and all its terms and conditions for copying, distributing or modifying the Program or works based on it.

6. Each time you redistribute the Program (or any work based on the Program), the recipient automatically receives a license from the original licensor to copy, distribute or modify the Program subject to these terms and conditions. You may not impose any further restrictions on the recipients' exercise of the rights granted herein. You are not responsible for enforcing compliance by third parties to this License.

7. If, as a consequence of a court judgment or allegation of patent infringement or for any other reason (not limited to patent issues), conditions are imposed on you (whether by court order, agreement or otherwise) that contradict the conditions of this License, they do not excuse you from the conditions of this License. If you cannot distribute so as to satisfy simultaneously your obligations under this License and any other pertinent obligations, then as a consequence you may not distribute the Program at all. For example, if a patent license would not permit royalty-free redistribution of the Program by all those who receive copies directly or indirectly through you, then the only way you could satisfy both it and this License would be to refrain entirely from distribution of the Program.

If any portion of this section is held invalid or unenforceable under any particular circumstance, the balance of the section is intended to apply and the section as a whole is intended to apply in other circumstances.

It is not the purpose of this section to induce you to infringe any patents or other property right claims or to contest validity of any such claims; this section has the sole purpose of protecting the integrity of the free software distribution system, which is implemented by public license practices. Many people have made generous contributions to the wide range of software distributed through that system in reliance on consistent application of that system; it is up to the author/donor to decide if he or she is willing to distribute software through any other system and a licensee cannot impose that choice.

This section is intended to make thoroughly clear what is believed to be a consequence of the rest of this License.

8. If the distribution and/or use of the Program is restricted in certain countries either by patents or by copyrighted interfaces, the original copyright holder who places the Program under this License may add an explicit geographical distribution limitation excluding those countries, so that distribution is permitted only in or among countries not thus excluded. In such case, this License incorporates the limitation as if written in the body of this License.

9. The Free Software Foundation may publish revised and/or new versions of the General Public License from time to time. Such new versions will be similar in spirit to the present version, but may differ in detail to address new problems or concerns.

Each version is given a distinguishing version number. If the Program specifies a version number of this License which applies to it and any later version, you have the option of following the terms and conditions either of that version or of any later version published by the Free Software Foundation. If the Program does not specify a version number of this License, you may choose any version ever published by the Free Software Foundation.

10. If you wish to incorporate parts of the Program into other free programs whose distribution conditions are different, write to the author to ask for permission. For software which is copyrighted by the Free Software Foundation, write to the Free Software Foundation; we sometimes make exceptions for this. Our decision will be guided by the two goals of preserving the free status of all derivatives of our free software and of promoting the sharing and reuse of software generally.

NO WARRANTY

11. BECAUSE THE PROGRAM IS LICENSED FREE OF CHARGE, THERE IS NO WARRANTY FOR THE PROGRAM, TO THE EXTENT PERMITTED BY APPLICABLE LAW. EXCEPT WHEN OTHERWISE STATED IN WRITING THE COPYRIGHT HOLDERS AND/OR OTHER PARTIES PROVIDE THE PROGRAM "AS IS" WITHOUT WARRANTY OF ANY KIND, EITHER EXPRESSED OR IMPLIED, INCLUDING, BUT NOT LIMITED TO, THE IMPLIED WARRANTIES OF MERCHANTABILITY AND FITNESS FOR A PARTICULAR PURPOSE. THE ENTIRE RISK AS TO THE QUALITY AND PERFORMANCE OF THE PROGRAM IS WITH YOU. SHOULD THE PROGRAM PROVE DEFECTIVE, YOU ASSUME THE COST OF ALL NECESSARY SERVICING, REPAIR OR CORRECTION.

12. IN NO EVENT UNLESS REQUIRED BY APPLICABLE LAW OR AGREED TO IN WRITING WILL ANY COPYRIGHT HOLDER, OR ANY OTHER PARTY WHO MAY MODIFY AND/OR REDISTRIBUTE THE PROGRAM AS PERMITTED ABOVE, BE LIABLE TO YOU FOR DAMAGES, INCLUDING ANY GENERAL, SPECIAL, INCIDENTAL OR CONSEQUENTIAL DAMAGES ARISING OUT OF THE USE OR INABILITY TO USE THE PROGRAM (INCLUDING BUT NOT LIMITED TO LOSS OF DATA OR DATA BEING RENDERED INACCURATE OR LOSSES SUSTAINED BY YOU OR THIRD PARTIES OR A FAILURE OF THE PROGRAM TO OPERATE WITH ANY OTHER PROGRAMS), EVEN IF SUCH HOLDER OR OTHER PARTY HAS BEEN ADVISED OF THE POSSIBILITY OF SUCH DAMAGES.

END OF TERMS AND CONDITIONS

本機で使われるソフトウェアライセンス情報 (つづき)

Exhibit (D)

GNU LESSER GENERAL PUBLIC LICENSE Version 2.1, February 1999

Copyright (C) 1991, 1999 Free Software Foundation, Inc.
59 Temple Place, Suite 330, Boston, MA 02111-1307 USA
Everyone is permitted to copy and distribute verbatim copies of this license document, but changing it is not allowed.

[This is the first released version of the Lesser GPL. It also counts as the successor of the GNU Library Public License, version 2, hence the version number 2.1.]

Preamble

The licenses for most software are designed to take away your freedom to share and change it. By contrast, the GNU General Public Licenses are intended to guarantee your freedom to share and change free software—to make sure the software is free for all its users.

This license, the Lesser General Public License, applies to some specially designated software packages—typically libraries—of the Free Software Foundation and other authors who decide to use it. You can use it too, but we suggest you first think carefully about whether this license or the ordinary General Public License is the better strategy to use in any particular case, based on the explanations below.

When we speak of free software, we are referring to freedom of use, not price. Our General Public Licenses are designed to make sure that you have the freedom to distribute copies of free software (and charge for this service if you wish); that you receive source code or can get it if you want it; that you can change the software and use pieces of it in new free programs; and that you are informed that you can do these things.

To protect your rights, we need to make restrictions that forbid distributors to deny you these rights or to ask you to surrender these rights. These restrictions translate to certain responsibilities for you if you distribute copies of the library or if you modify it.

For example, if you distribute copies of the library, you must make sure that you, too, receive or can get the source code. If you link other code with the library, you must provide complete object files to the recipients, so that they can relink them with the library after making changes to the library and recompiling it. And you must show them these terms so they know their rights.

We protect your rights with a two-step method: (1) we copyright the library, and (2) we offer you this license, which gives you legal permission to copy, distribute and/or modify the library.

To protect each distributor, we want to make it very clear that there is no warranty for the free library. Also, if the library is modified by someone else and passed on, the recipients should know that what they have is not the original version, so that the original author's reputation will not be affected by problems that might be introduced by others.

Finally, software patents pose a constant threat to the existence of any free program. We wish to make sure that a company cannot effectively restrict the users of a free program by obtaining a restrictive patent from a patent holder. Therefore, we insist that any patent license obtained for a version of the library must be consistent with the full freedom of use specified in this license.

Most GNU software, including some libraries, is covered by the ordinary GNU General Public License. This license, the GNU Lesser General Public License, applies to certain designated libraries, and is quite different from the ordinary General Public License. We use this license for certain libraries in order to permit linking those libraries into non-free programs.

When a program is linked with a library, whether statically or using a shared library, the combination of the two is legally speaking a combined work, a derivative of the original library. The ordinary General Public License therefore permits such linking only if the entire combination fits its criteria of freedom. The Lesser General Public License permits more lax criteria for linking other code with the library.

We call this license the "Lesser" General Public License because it does less to protect the user's freedom than the ordinary General Public License. It also provides other free software developers less of an advantage over competing non-free programs. These disadvantages are the reason we use the ordinary General Public License for many libraries. However, the Lesser license provides advantages in certain special circumstances.

For example, on rare occasions, there may be a special need to encourage the widest possible use of a certain library, so that it becomes a de-facto standard. To achieve this, non-free programs must be allowed to use the library. A more frequent case is that a free library does the same job as widely used non-free libraries. In this case, there is little to gain by limiting the free library to free software only, so we use the Lesser General Public License.

In other cases, permission to use a particular library in non-free programs enables a greater number of people to use a large body of free software. For example, permission to use the GNU C Library in non-free programs enables many more people to use the whole GNU operating system, as well as its variant, the GNU/Linux operating system.

Although the Lesser General Public License is less protective of the users' freedom, it does ensure that the user of a program that is linked with the Library has the freedom and the wherewithal to run that program using a modified version of the Library.

The precise terms and conditions for copying, distribution and modification follow. Pay close attention to the difference between a "work based on the library" and a "work that uses the library". The former contains code derived from the library, whereas the latter must be combined with the library in order to run.

GNU LESSER GENERAL PUBLIC LICENSE TERMS AND CONDITIONS FOR COPYING, DISTRIBUTION AND MODIFICATION

0. This License Agreement applies to any software library or other program which contains a notice placed by the copyright holder or other authorized party saying it may be distributed under the terms of this Lesser General Public License (also called "this License"). Each licensee is addressed as "you".

A "library" means a collection of software functions and/or data prepared so as to be conveniently linked with application programs (which use some of those functions and data) to form executables.

The "Library" below, refers to any such software library or work which has been distributed under these terms. A "work based on the Library" means either the Library or any derivative work under copyright law: that is to say, a work containing the Library or a portion of it, either verbatim or with modifications and/or translated straightforwardly into another language. (Hereinafter, translation is included without limitation in the term "modification".)

"Source code" for a work means the preferred form of the work for making modifications to it. For a library, complete source code means all the source code for all modules it contains, plus any associated interface definition files, plus the scripts used to control compilation and installation of the library.

Activities other than copying, distribution and modification are not covered by this License; they are outside its scope. The act of running a program using the Library is not restricted, and output from such a program is covered only if its contents constitute a work based on the Library (independent of the use of the Library in a tool for writing it). Whether that is true depends on what the Library does and what the program that uses the Library does.

1. You may copy and distribute verbatim copies of the Library's complete source code as you receive it, in any medium, provided you conspicuously and appropriately publish on each copy an appropriate copyright notice and disclaimer of warranty, keep intact all the notices that refer to this License and to the absence of any warranty, and distribute a copy of this License along with the Library.

You may charge a fee for the physical act of transferring a copy, and you may at your option offer warranty protection in exchange for a fee.

2. You may modify your copy or copies of the Library or any portion of it, thus forming a work based on the Library, and copy and distribute such modifications or work under the terms of Section 1 above, provided that you also meet all of these conditions:

- The modified work must itself be a software library.
- You must cause the files modified to carry prominent notices stating that you changed the files and the date of any change.

c) You must cause the whole of the work to be licensed at no charge to all third parties under the terms of this License.

d) If a facility in the modified Library refers to a function or a table of data to be supplied by an application program that uses the facility, other than as an argument passed when the facility is invoked, then you must make a good faith effort to ensure that, in the event an application does not supply such function or table, the facility still operates, and performs whatever part of its purpose remains meaningful.

(For example, a function in a library to compute square roots has a purpose that is entirely well-defined independent of the application. Therefore, Subsection 2d requires that any application-supplied function or table used by this function must be optional; if the application does not supply it, the square root function must still compute square roots.)

These requirements apply to the modified work as a whole. If identifiable sections of that work are not derived from the Library, and can be reasonably considered independent and separate works in themselves, then this License, and its terms, do not apply to those sections when you distribute them as separate works. But when you distribute the same sections as part of a whole which is a work based on the Library, the distribution of the whole must be on the terms of this License, whose permissions for other licenses extend to the entire whole, and thus to each and every part regardless of who wrote it.

Thus, it is not the intent of this section to claim rights or contest your rights to work written entirely by you; rather, the intent is to exercise the right to control the distribution of derivative or collective works based on the Library.

In addition, mere aggregation of another work not based on the Library with the Library (or with a work based on the Library) on a volume of a storage or distribution medium does not bring the other work under the scope of this License.

3. You may opt to apply the terms of the ordinary GNU General Public License instead of this License to a given copy of the Library. To do this, you must alter all the notices that refer to this License, so that they refer to the ordinary GNU General Public License, version 2, instead of to this License. (If a newer version than version 2 of the ordinary GNU General Public License has appeared, then you can specify that version instead if you wish.) Do not make any other change in these notices.

Once this change is made in a given copy, it is irreversible for that copy, so the ordinary GNU General Public License applies to all subsequent copies and derivative works made from that copy.

This option is useful when you wish to copy part of the code of the Library into a program that is not a library.

4. You may copy and distribute the Library (or a portion or derivative of it, under Section 2) in object code or executable form under the terms of Sections 1 and 2 above provided that you accompany it with the complete corresponding machine-readable source code, which must be distributed under the terms of Sections 1 and 2 above on a medium customarily used for software interchange.

If distribution of object code is made by offering access to copy from a designated place, then offering equivalent access to copy the source code from the same place satisfies the requirement to distribute the source code, even though third parties are not compelled to copy the source along with the object code.

5. A program that contains no derivative of any portion of the Library, but is designed to work with the Library by being compiled or linked with it, is called a "work that uses the Library". Such a work, in isolation, is not a derivative work of the Library, and therefore falls outside the scope of this License.

However, linking a "work that uses the Library" with the Library creates an executable that is a derivative of the Library (because it contains portions of the Library), rather than a "work that uses the Library". The executable is therefore covered by this License. Section 6 states terms for distribution of such executables.

When a "work that uses the Library" uses material from a header file that is part of the Library, the object code for the work may be a derivative work of the Library even though the source code is not. Whether this is true is especially significant if the work can be linked without the Library, or if the work is itself a library. The threshold for this to be true is not precisely defined by law.

If such an object file uses only numerical parameters, data structure layouts and accessors, and small macros and small inline functions (ten lines or less in length), then the use of the object file is unrestricted, regardless of whether it is legally a derivative work. (Executables containing this object code plus portions of the Library will still fall under Section 6.)

Otherwise, if the work is a derivative of the Library, you may distribute the object code for the work under the terms of Section 6. Any executables containing that work also fall under Section 6, whether or not they are linked directly with the Library itself.

6. As an exception to the Sections above, you may also combine or link a "work that uses the Library" with the Library to produce a work containing portions of the Library, and distribute that work under terms of your choice, provided that the terms permit modification of the work for the customer's own use and reverse engineering for debugging such modifications.

You must give prominent notice with each copy of the work that the Library is used in it and that the Library and its use are covered by this License. You must supply a copy of this License. If the work during execution displays copyright notices, you must include the copyright notice for the Library among them, as well as a reference directing the user to the copy of this License. Also, you must do one of these things:

a) Accompany the work with the complete corresponding machine-readable source code for the Library including whatever changes were used in the work (which must be distributed under Sections 1 and 2 above); and, if the work is an executable linked with the Library, with the complete machine-readable "work that uses the Library", as object code and/or source code, so that the user can modify the Library and then relink to produce a modified executable containing the modified Library. (It is understood that the user who changes the contents of definitions files in the Library will not necessarily be able to recompile the application to use the modified definitions.)

b) Use a suitable shared library mechanism for linking with the Library. A suitable mechanism is one that (1) uses at run time a copy of the library already present on the user's computer system, rather than copying library functions into the executable, and (2) will operate properly with a modified version of the library, if the user installs one, as long as the modified version is interface-compatible with the version that the work was made with.

c) Accompany the work with a written offer, valid for at least three years, to give the same user the materials specified in Subsection 6a, above, for a charge no more than the cost of performing this distribution.

d) If distribution of the work is made by offering access to copy from a designated place, offer equivalent access to copy the above specified materials from the same place.

e) Verify that the user has already received a copy of these materials or that you have already sent this user a copy.

For an executable, the required form of the "work that uses the Library" must include any data and utility programs needed for reproducing the executable from it. However, as a special exception, the materials to be distributed need not include anything that is normally distributed (in either source or binary form) with the major components (compiler, kernel, and so on) of the operating system on which the executable runs, unless that component itself accompanies the executable.

It may happen that this requirement contradicts the license restrictions of other proprietary libraries that do not normally accompany the operating system. Such a contradiction means you cannot use both them and the Library together in an executable that you distribute.

7. You may place library facilities that are a work based on the Library side-by-side in a single library together with other library facilities not covered by this License, and distribute such a combined library, provided that the separate distribution of the work based on the Library and of the other library facilities is otherwise permitted, and provided that you do these two things:

a) Accompany the combined library with a copy of the same work based on the Library, uncombined with any other library facilities. This must be distributed under the terms of the Sections above.

b) Give prominent notice with the combined library of the fact that part of it is a work based on the Library, and explaining where to find the accompanying uncombined form of the same work.

8. You may not copy, modify, sublicense, link with, or distribute the Library except as expressly provided under this License. Any attempt otherwise to copy, modify, sublicense, link with, or

distribute the Library is void, and will automatically terminate your rights under this License. However, parties who have received copies, or rights, from you under this License will not have their licenses terminated so long as such parties remain in full compliance.

9. You are not required to accept this License, since you have not signed it. However, nothing else grants you permission to modify or distribute the Library or its derivative works. These actions are prohibited by law if you do not accept this License. Therefore, by modifying or distributing the Library (or any work based on the Library), you indicate your acceptance of this License to do so, and all its terms and conditions for copying, distributing or modifying the Library or works based on it.

10. Each time you redistribute the Library (or any work based on the Library), the recipient automatically receives a license from the original licensor to copy, distribute, link with or modify the Library subject to these terms and conditions. You may not impose any further restrictions on the recipients' exercise of the rights granted herein. You are not responsible for enforcing compliance by third parties with this License.

11. If, as a consequence of a court judgment or allegation of patent infringement or for any other reason (not limited to patent issues), conditions are imposed on you (whether by court order, agreement or otherwise) that contradict the conditions of this License, they do not excuse you from the conditions of this License. If you cannot distribute so as to satisfy simultaneously your obligations under this License and any other pertinent obligations, then as a consequence you may not distribute the Library at all. For example, if a patent license would not permit royalty-free redistribution of the Library by all those who receive copies directly or indirectly through you, then the only way you could satisfy both it and this License would be to refrain entirely from distribution of the Library.

If any portion of this section is held invalid or unenforceable under any particular circumstance, the balance of the section is intended to apply, and the section as a whole is intended to apply in other circumstances.

It is not the purpose of this section to induce you to infringe any patents or other property right claims or to contest validity of any such claims; this section has the sole purpose of protecting the integrity of the free software distribution system which is implemented by public license practices. Many people have made generous contributions to the wide range of software distributed through that system in reliance on consistent application of that system; it is up to the author/donor to decide if he or she is willing to distribute software through any other system and a licensee cannot impose that choice.

This section is intended to make thoroughly clear what is believed to be a consequence of the rest of this License.

12. If the distribution and/or use of the Library is restricted in certain countries either by patents or by copyrighted interfaces, the original copyright holder who places the Library under this License may add an explicit geographical distribution limitation excluding those countries, so that distribution is permitted only in or among countries not thus excluded. In such case, this License incorporates the limitation as if written in the body of this License.

13. The Free Software Foundation may publish revised and/or new versions of the Lesser General Public License from time to time. Such new versions will be similar in spirit to the present version, but may differ in detail to address new problems or concerns.

Each version is given a distinguishing version number. If the Library specifies a version number of this License which applies to it and "any later version", you have the option of following the terms and conditions either of that version or of any later version published by the Free Software Foundation. If the Library does not specify a license version number, you may choose any version ever published by the Free Software Foundation.

14. If you wish to incorporate parts of the Library into other free programs whose distribution conditions are incompatible with these, write to the author to ask for permission. For software which is copyrighted by the Free Software Foundation, write to the Free Software Foundation; we sometimes make exceptions for this. Our decision will be guided by the two goals of preserving the free status of all derivatives of our free software and of promoting the sharing and reuse of software generally.

NO WARRANTY

15. BECAUSE THE LIBRARY IS LICENSED FREE OF CHARGE, THERE IS NO WARRANTY FOR THE LIBRARY, TO THE EXTENT PERMITTED BY APPLICABLE LAW. EXCEPT WHEN OTHERWISE STATED IN WRITING THE COPYRIGHT HOLDERS AND/OR OTHER PARTIES PROVIDE THE LIBRARY "AS IS" WITHOUT WARRANTY OF ANY KIND, EITHER EXPRESSED OR IMPLIED, INCLUDING, BUT NOT LIMITED TO, THE IMPLIED WARRANTIES OF MERCHANTABILITY AND FITNESS FOR A PARTICULAR PURPOSE. THE ENTIRE RISK AS TO THE QUALITY AND PERFORMANCE OF THE LIBRARY IS WITH YOU. SHOULD THE LIBRARY PROVE DEFECTIVE, YOU ASSUME THE COST OF ALL NECESSARY SERVICING, REPAIR OR CORRECTION.

16. IN NO EVENT UNLESS REQUIRED BY APPLICABLE LAW OR AGREED TO IN WRITING WILL ANY COPYRIGHT HOLDER, OR ANY OTHER PARTY WHO MAY MODIFY AND/OR REDISTRIBUTE THE LIBRARY AS PERMITTED ABOVE, BE LIABLE TO YOU FOR DAMAGES, INCLUDING ANY GENERAL, SPECIAL, INCIDENTAL OR CONSEQUENTIAL DAMAGES ARISING OUT OF THE USE OR INABILITY TO USE THE LIBRARY (INCLUDING BUT NOT LIMITED TO LOSS OF DATA OR DATA BEING RENDERED INACCURATE OR LOSSES SUSTAINED BY YOU OR THIRD PARTIES OR A FAILURE OF THE LIBRARY TO OPERATE WITH ANY OTHER SOFTWARE), EVEN IF SUCH HOLDER OR OTHER PARTY HAS BEEN ADVISED OF THE POSSIBILITY OF SUCH DAMAGES.

END OF TERMS AND CONDITIONS

How to Apply These Terms to Your New Libraries

If you develop a new library, and you want it to be of the greatest possible use to the public, we recommend making it free software that everyone can redistribute and change. You can do so by permitting redistribution under these terms (or, alternatively, under the terms of the ordinary General Public License).

To apply these terms, attach the following notices to the library. It is safest to attach them to the start of each source file to most effectively convey the exclusion of warranty; and each file should have at least the "copyright" line and a pointer to where the full notice is found.

```
<one line to give the library's name and a brief idea of what it does.>
Copyright (C) <year> <name of author>
```

This library is free software; you can redistribute it and/or modify it under the terms of the GNU Lesser General Public License as published by the Free Software Foundation; either version 2.1 of the License, or (at your option) any later version.

This library is distributed in the hope that it will be useful, but WITHOUT ANY WARRANTY; without even the implied warranty of MERCHANTABILITY or FITNESS FOR A PARTICULAR PURPOSE. See the GNU Lesser General Public License for more details.

You should have received a copy of the GNU Lesser General Public License along with this library; if not, write to the Free Software Foundation, Inc., 59 Temple Place, Suite 330, Boston, MA 02111-1307 USA

Also add information on how to contact you by electronic and paper mail.

You should also get your employer (if you work as a programmer) or your school, if any, to sign a "copyright disclaimer" for the library, if necessary. Here is a sample; alter the names:

Yooyodyne, Inc., hereby disclaims all copyright interest in the library 'Frob' (a library for tweaking knobs) written by James Random Hacker.

```
<signature of Ty Coon>, 1 April 1990
Ty Coon, President of Vice
```

That's all there is to it!

Exhibit (E)

GNU LESSER GENERAL PUBLIC LICENSE Version 2.1, February 1999

Copyright (C) 1991, 1999 Free Software Foundation, Inc.
51 Franklin St, Fifth Floor, Boston, MA 02110-1301 USA
Everyone is permitted to copy and distribute verbatim copies of this license document, but changing it is not allowed.

[This is the first released version of the Lesser GPL. It also counts as the successor of the GNU Library Public License, version 2, hence the version number 2.1.]

Preamble

The licenses for most software are designed to take away your freedom to share and change it. By contrast, the GNU General Public Licenses are intended to guarantee your freedom to share and change free software--to make sure the software is free for all its users.

This license, the Lesser General Public License, applies to some specially designated software packages--typically libraries--of the Free Software Foundation and other authors who decide to use it. You can use it too, but we suggest you first think carefully about whether this license or the ordinary General Public License is the better strategy to use in any particular case, based on the explanations below.

When we speak of free software, we are referring to freedom of use, not price. Our General Public Licenses are designed to make sure that you have the freedom to distribute copies of free software (and charge for this service if you wish); that you receive source code or can get it if you want it; that you can change the software and use pieces of it in new free programs; and that you are informed that you can do these things.

To protect your rights, we need to make restrictions that forbid distributors to deny you these rights or to ask you to surrender these rights. These restrictions translate to certain responsibilities for you if you distribute copies of the library or if you modify it.

For example, if you distribute copies of the library, whether gratis or for a fee, you must give the recipients all the rights that we gave you. You must make sure that they, too, receive or can get the source code. If you link other code with the library, you must provide complete object files to the recipients, so that they can relink them with the library after making changes to the library and recompiling it. And you must show them these terms so they know their rights.

We protect your rights with a two-step method: (1) we copyright the library, and (2) we offer you this license, which gives you legal permission to copy, distribute and/or modify the library.

To protect each distributor, we want to make it very clear that there is no warranty for the free library. Also, if the library is modified by someone else and passed on, the recipients should know that what they have is not the original version, so that the original author's reputation will not be affected by problems that might be introduced by others.

Finally, software patents pose a constant threat to the existence of any free program. We wish to make sure that a company cannot effectively restrict the users of a free program by obtaining a restrictive license from a patent holder. Therefore, we insist that any patent license obtained for a version of the library must be consistent with the full freedom of use specified in this license.

Most GNU software, including some libraries, is covered by the ordinary GNU General Public License. This license, the GNU Lesser General Public License, applies to certain designated libraries, and is quite different from the ordinary General Public License. We use this license for certain libraries in order to permit linking those libraries into non-free programs.

When a program is linked with a library, whether statically or using a shared library, the combination of the two is legally speaking a combined work, a derivative of the original library. The ordinary General Public License therefore permits such linking only if the entire combination fits its criteria of freedom. The Lesser General Public License permits more lax criteria for linking other code with the library.

We call this license the "Lesser" General Public License because it does less to protect the user's freedom than the ordinary General Public License. It also provides other free software developers less of an advantage over competing non-free programs. These disadvantages are the reason we use the ordinary General Public License for many libraries. However, the Lesser license provides advantages in certain special circumstances.

For example, on rare occasions, there may be a special need to encourage the widest possible use of a certain library, so that it becomes a de-facto standard. To achieve this, non-free programs must be allowed to use the library. A more frequent case is that a free library does the same job as widely used non-free libraries. In this case, there is little to gain by limiting the free library to free software only, so we use the Lesser General Public License.

In other cases, permission to use a particular library in non-free programs enables a greater number of people to use a large body of free software. For example, permission to use the GNU C Library in non-free programs enables many more people to use the whole GNU operating system, as well as its variant, the GNU/Linux operating system.

Although the Lesser General Public License is less protective of the users' freedom, it does ensure that the user of a program that is linked with the Library has the freedom and the wherewithal to run that program using a modified version of the Library.

The precise terms and conditions for copying, distribution and modification follow. Pay close attention to the difference between a "work based on the library" and a "work that uses the library". The former contains code derived from the library, whereas the latter must be combined with the library in order to run.

GNU LESSER GENERAL PUBLIC LICENSE TERMS AND CONDITIONS FOR COPYING, DISTRIBUTION AND MODIFICATION

0. This License Agreement applies to any software library or other program which contains a notice placed by the copyright holder or other authorized party saying it may be distributed under the terms of this Lesser General Public License (also called "this License"). Each licensee is addressed as "you".

A "library" means a collection of software functions and/or data prepared so as to be conveniently linked with application programs (which use some of those functions and data) to form executables.

The "Library" below, refers to any such software library or work which has been distributed under these terms. A "work based on the Library" means either the Library or any derivative work under copyright law: that is to say, a work containing the Library or a portion of it, either verbatim or with modifications and/or translated straightforwardly into another language. (Hereinafter, translation is included without limitation in the term "modification".)

"Source code" for a work means the preferred form of the work for making modifications to it. For a library, complete source code means all the source code for all modules it contains, plus any associated interface definition files, plus the scripts used to control compilation and installation of the library.

Activities other than copying, distribution and modification are not covered by this License; they are outside its scope. The act of running a program using the Library is not restricted, and output from such a program is covered only if its contents constitute a work based on the Library (independent of the use of the Library in a tool for writing it). Whether that is true depends on what the Library does and what the program that uses the Library does.

1. You may copy and distribute verbatim copies of the Library's complete source code as you receive it, in any medium, provided that you conspicuously and appropriately publish on each copy an appropriate copyright notice and disclaimer of warranty; keep intact all the notices that refer to this License and to the absence of any warranty; and distribute a copy of this License along with the Library.

You may charge a fee for the physical act of transferring a copy, and you may at your option offer warranty protection in exchange for a fee.

2. You may modify your copy or copies of the Library or any portion of it, thus forming a work based on the Library, and copy and distribute such modifications or work under the terms of Section 1 above, provided that you also meet all of these conditions:

a) The modified work must itself be a software library.

b) You must cause the files modified to carry prominent notices stating that you changed the files and the date of any change.

本機で使われるソフトウェアライセンス情報 (つづき)

c) You must cause the whole of the work to be licensed at no charge to all third parties under the terms of this License.

d) If a facility in the modified Library refers to a function or a table of data to be supplied by an application program that uses the facility, other than an argument passed when the facility is invoked, then you must make a good faith effort to ensure that, in the event an application does not supply such function or table, the facility still operates, and performs whatever part of its purpose remains meaningful.

(For example, a function in a library to compute square roots has a purpose that is entirely well-defined independent of the application. Therefore, Subsection 2d requires that any application-supplied function or table used by this function must be optional: if the application does not supply it, the square root function must still compute square roots.)

These requirements apply to the modified work as a whole. If identifiable sections of that work are not derived from the Library, and can be reasonably considered independent and separate works in themselves, then this License, and its terms, do not apply to those sections when you distribute them as separate works. But when you distribute the same sections as part of a whole which is a work based on the Library, the distribution of the whole must be on the terms of this License, whose permissions for other licensees extend to the entire whole, and thus to each and every part regardless of who wrote it.

Thus, it is not the intent of this section to claim rights or contest your rights to work written entirely by you; rather, the intent is to exercise the right to control the distribution of derivative or collective works based on the Library.

In addition, mere aggregation of another work not based on the Library with the Library (or with a work based on the Library) on a volume of a storage or distribution medium does not bring the other work under the scope of this License.

3. You may opt to apply the terms of the ordinary GNU General Public License instead of this License to a given copy of the Library. To do this, you must alter all the notices that refer to this License, so that they refer to the ordinary GNU General Public License, version 2, instead of to this License. (If a newer version than version 2 of the ordinary GNU General Public License has appeared, then you can specify that version instead if you wish.) Do not make any other change in these notices.

Once this change is made in a given copy, it is irreversible for that copy, so the ordinary GNU General Public License applies to all subsequent copies and derivative works made from that copy.

This option is useful when you wish to copy part of the code of the Library into a program that is not a library.

4. You may copy and distribute the Library (or a portion or derivative of it, under Section 2) in object code or executable form under the terms of Sections 1 and 2 above provided that you accompany it with the complete corresponding machine-readable source code, which must be distributed under the terms of Sections 1 and 2 above on a medium customarily used for software interchange.

If distribution of object code is made by offering access to copy from a designated place, then offering equivalent access to copy the source code from the same place satisfies the requirement to distribute the source code, even though third parties are not compelled to copy the source along with the object code.

5. A program that contains no derivative of any portion of the Library, but is designed to work with the Library by being compiled or linked with it, is called a "work that uses the Library". Such a work, in isolation, is not a derivative work of the Library, and therefore falls outside the scope of this License.

However, linking a "work that uses the Library" with the Library creates an executable that is a derivative of the Library (because it contains portions of the Library), rather than a "work that uses the Library". The executable is therefore covered by this License. Section 6 states terms for distribution of such executables.

When a "work that uses the Library" uses material from a header file that is part of the Library, the object code for the work may be a derivative work of the Library even though the source code is not. Whether this is true is especially significant if the work can be linked without the Library, or if the work is itself a library. The threshold for this to be true is not precisely defined by law.

If such an object file uses only numerical parameters, data structure layouts and accessors, and small macros and small inline functions (ten lines or less in length), then the use of the object file is unrestricted, regardless of whether it is legally a derivative work. (Executables containing this object code plus portions of the Library will still fall under Section 6.)

Otherwise, if the work is a derivative of the Library, you may distribute the object code for the work under the terms of Section 6. Any executables containing that work also fall under Section 6, whether or not they are linked directly with the Library itself.

6. As an exception to the Sections above, you may also combine or link a "work that uses the Library" with the Library to produce a work containing portions of the Library, and distribute that work under terms of your choice, provided that the terms permit modification of the work for the customer's own use and reverse engineering for debugging such modifications.

You must give prominent notice with each copy of the work that the Library is used in it and that the Library and its use are covered by this License. You must supply a copy of this License. If the work during execution displays copyright notices, you must include the copyright notice for the Library among them, as well as a reference directing the user to the copy of this License. Also, you must do one of these things:

a) Accompany the work with the complete corresponding machine-readable source code for the Library including whatever changes were used in the work (which must be distributed under Sections 1 and 2 above); and, if the work is an executable linked with the Library, with the complete machine-readable "work that uses the Library", as object code and/or source code, so that the user can modify the Library and then relink to produce a modified executable containing the modified Library. (It is understood that the user who changes the contents of definitions files in the Library will not necessarily be able to recompile the application to use the modified definitions.)

b) Use a suitable shared library mechanism for linking with the Library. A suitable mechanism is one that (1) uses at run time a copy of the library already present on the user's computer system, rather than copying library functions into the executable, and (2) will operate properly with a modified version of the library, if the user installs one, as long as the modified version is interface-compatible with the version that the work was made with.

c) Accompany the work with a written offer, valid for at least three years, to give the same user the materials specified in Subsection 6a, above, for a charge no more than the cost of performing this distribution.

d) If distribution of the work is made by offering access to copy from a designated place, offer equivalent access to copy the above specified materials from the same place.

e) Verify that the user has already received a copy of these materials or that you have already sent this user a copy.

For an executable, the required form of the "work that uses the Library" must include any data and utility programs needed for reproducing the executable from it. However, as a special exception, the materials to be distributed need not include anything that is normally distributed (in either source or binary form) with the major components (compiler, kernel, and so on) of the operating system on which the executable runs, unless that component itself accompanies the executable.

It may happen that this requirement contradicts the license restrictions of other proprietary libraries that do not normally accompany the operating system. Such a contradiction means you cannot use both them and the Library together in an executable that you distribute.

7. You may place library facilities that are a work based on the Library side-by-side in a single library together with other library facilities not covered by this License, and distribute such a combined library, provided that the separate distribution of the work based on the Library and of the other library facilities is otherwise permitted, and provided that you do these two things:

a) Accompany the combined library with a copy of the same work based on the Library, uncombined with any other library facilities. This must be distributed under the terms of the Sections above.

b) Give prominent notice with the combined library of the fact that part of it is a work based on the Library, and explaining where to find the accompanying uncombined form of the same work.

8. You may not copy, modify, sublicense, link with, or distribute the Library except as expressly provided under this License. Any attempt otherwise to copy, modify, sublicense, link with, or

distribute the Library is void, and will automatically terminate your rights under this License. However, parties who have received copies or rights, from you under this License will not have their licenses terminated so long as such parties remain in full compliance.

9. You are not required to accept this License, since you have not signed it. However, nothing else grants you permission to modify or distribute the Library or its derivative works. These actions are prohibited by law if you do not accept this License. Therefore, by modifying or distributing the Library (or any work based on the Library), you indicate your acceptance of this License to do so, and all its terms and conditions for copying, distributing or modifying the Library or works based on it.

10. Each time you redistribute the Library (or any work based on the Library), the recipient automatically receives a license from the original licensor to copy, distribute, link with or modify the Library subject to these terms and conditions. You may not impose any further restrictions on the recipients' exercise of the rights granted herein. You are not responsible for enforcing compliance by third parties with this License.

11. If, as a consequence of a court judgment or allegation of patent infringement or for any other reason (not limited to patent issues), conditions are imposed on you (whether by court order, agreement or otherwise) that contradict the conditions of this License, they do not excuse you from the conditions of this License. If you cannot distribute so as to satisfy simultaneously your obligations under this License and any other pertinent obligations, then as a consequence you may not distribute the Library at all. For example, if a patent license would not permit royalty-free redistribution of the Library by all those who receive copies directly or indirectly through you, then the only way you could satisfy both it and this License would be to refrain entirely from distribution of the Library.

If any portion of this section is held invalid or unenforceable under any particular circumstance, the balance of the section is intended to apply, and the section as a whole is intended to apply in other circumstances.

It is not the purpose of this section to induce you to infringe any patents or other property right claims or to contest validity of any such claims; this section has the sole purpose of protecting the integrity of the free software distribution system which is implemented by public license practices. Many people have made generous contributions to the wide range of software distributed through that system in reliance on consistent application of that system; it is up to the author/donor to decide if he or she is willing to distribute software through any other system and a licensee cannot impose that choice.

This section is intended to make thoroughly clear what is believed to be a consequence of the rest of this License.

12. If the distribution and/or use of the Library is restricted in certain countries either by patents or by copyrighted interfaces, the original copyright holder who places the Library under this License may add an explicit geographical distribution limitation excluding those countries, so that distribution is permitted only in or among countries not thus excluded. In such case, this License incorporates the limitation as if written in the body of this License.

13. The Free Software Foundation may publish revised and/or new versions of the Lesser General Public License from time to time. Such new versions will be similar in spirit to the present version, but may differ in detail to address new problems or concerns.

Each version is given a distinguishing version number. If the Library specifies a version number of this License which applies to it and "any later version", you have the option of following the terms and conditions either of that version or of any later version published by the Free Software Foundation. If the Library does not specify a license version number, you may choose any version ever published by the Free Software Foundation.

14. If you wish to incorporate parts of the Library into other free programs whose distribution conditions are incompatible with these, write to the author to ask for permission. For software which is copyrighted by the Free Software Foundation, write to the Free Software Foundation; we sometimes make exceptions for this. Our decision will be guided by the two goals of preserving the free status of all derivatives of our free software and of promoting the sharing and reuse of software generally.

NO WARRANTY

15. BECAUSE THE LIBRARY IS LICENSED FREE OF CHARGE, THERE IS NO WARRANTY FOR THE LIBRARY, TO THE EXTENT PERMITTED BY APPLICABLE LAW. EXCEPT WHEN OTHERWISE STATED IN WRITING THE COPYRIGHT HOLDERS AND/OR OTHER PARTIES PROVIDE THE LIBRARY "AS IS" WITHOUT WARRANTY OF ANY KIND, EITHER EXPRESSED OR IMPLIED, INCLUDING, BUT NOT LIMITED TO, THE IMPLIED WARRANTIES OF MERCHANTABILITY AND FITNESS FOR A PARTICULAR PURPOSE. THE ENTIRE RISK AS TO THE QUALITY AND PERFORMANCE OF THE LIBRARY IS WITH YOU. SHOULD THE LIBRARY PROVE DEFECTIVE, YOU ASSUME THE COST OF ALL NECESSARY SERVICING, REPAIR OR CORRECTION.

16. IN NO EVENT UNLESS REQUIRED BY APPLICABLE LAW OR AGREED TO IN WRITING WILL ANY COPYRIGHT HOLDER, OR ANY OTHER PARTY WHO MAY MODIFY AND/OR REDISTRIBUTE THE LIBRARY AS PERMITTED ABOVE, BE LIABLE TO YOU FOR DAMAGES, INCLUDING ANY GENERAL, SPECIAL, INCIDENTAL OR CONSEQUENTIAL DAMAGES ARISING OUT OF THE USE OR INABILITY TO USE THE LIBRARY (INCLUDING BUT NOT LIMITED TO LOSS OF DATA OR DATA BEING RENDERED INACCURATE OR LOSSES SUSTAINED BY YOU OR THIRD PARTIES OR A FAILURE OF THE LIBRARY TO OPERATE WITH ANY OTHER SOFTWARE), EVEN IF SUCH HOLDER OR OTHER PARTY HAS BEEN ADVISED OF THE POSSIBILITY OF SUCH DAMAGES.

END OF TERMS AND CONDITIONS

How to Apply These Terms to Your New Libraries

If you develop a new library, and you want it to be of the greatest possible use to the public, we recommend making it free software that everyone can redistribute and change. You can do so by permitting redistribution under these terms (or, alternatively, under the terms of the ordinary General Public License).

To apply these terms, attach the following notices to the library. It is safest to attach them to the start of each source file to most effectively convey the exclusion of warranty; and each file should have at least the "copyright" line and a pointer to where the full notice is found.

<one line to give the library's name and a brief idea of what it does.>
Copyright (C) <year> <name of author>

This library is free software; you can redistribute it and/or modify it under the terms of the GNU Lesser General Public License as published by the Free Software Foundation; either version 2.1 of the License, or (at your option) any later version.

This library is distributed in the hope that it will be useful, but WITHOUT ANY WARRANTY; without even the implied warranty of MERCHANTABILITY or FITNESS FOR A PARTICULAR PURPOSE. See the GNU Lesser General Public License for more details.

You should have received a copy of the GNU Lesser General Public License along with this library; if not, write to the Free Software Foundation, Inc., 51 Franklin St, Fifth Floor, Boston, MA 02110-1301 USA

Also add information on how to contact you by electronic and paper mail.

You should also get your employer (if you work as a programmer) or your school, if any, to sign a "copyright disclaimer" for the library, if necessary. Here is a sample, alter the names:

Yooyodny, Inc., hereby disclaims all copyright interest in the library 'Frob' (a library for tweaking knobs) written by James Random Hacker.

<signature of Ty Coon>, 1 April 1990
Ty Coon, President of Vice

That's all there is to it!

Exhibit (F)

Copyright (c) 2000-2003 Intel Corporation
All rights reserved.

Redistribution and use in source and binary forms, with or without modification, are permitted provided that the following conditions are met:

* Redistributions of source code must retain the above copyright notice, this list of conditions and the following disclaimer.

* Redistributions in binary form must reproduce the above copyright notice, this list of conditions and the following disclaimer in the documentation and/or other materials provided with the distribution.

* Neither name of Intel Corporation nor the names of its contributors may be used to endorse or promote products derived from this software without specific prior written permission.

THIS SOFTWARE IS PROVIDED BY THE COPYRIGHT HOLDERS AND CONTRIBUTORS "AS IS" AND ANY EXPRESS OR IMPLIED WARRANTIES, INCLUDING, BUT NOT LIMITED TO, THE IMPLIED WARRANTIES OF MERCHANTABILITY AND FITNESS FOR A PARTICULAR PURPOSE ARE DISCLAIMED. IN NO EVENT SHALL INTEL OR CONTRIBUTORS BE LIABLE FOR ANY DIRECT, INDIRECT, INCIDENTAL, SPECIAL, EXEMPLARY, OR CONSEQUENTIAL DAMAGES (INCLUDING, BUT NOT LIMITED TO, PROCUREMENT OF SUBSTITUTE GOODS OR SERVICES; LOSS OF USE, DATA, OR PROFITS; OR BUSINESS INTERRUPTION) HOWEVER CAUSED AND ON ANY THEORY OF LIABILITY, WHETHER IN CONTRACT, STRICT LIABILITY, OR TORT (INCLUDING NEGLIGENCE OR OTHERWISE) ARISING IN ANY WAY OUT OF THE USE OF THIS SOFTWARE, EVEN IF ADVISED OF THE POSSIBILITY OF SUCH DAMAGE.

Exhibit (G)

Copyright (C) 1998-2004 WIDE Project.
All rights reserved.

Redistribution and use in source and binary forms, with or without modification, are permitted provided that the following conditions are met:

1. Redistributions of source code must retain the above copyright notice, this list of conditions and the following disclaimer.

2. Redistributions in binary form must reproduce the above copyright notice, this list of conditions and the following disclaimer in the documentation and/or other materials provided with the distribution.

3. Neither the name of the project nor the names of its contributors may be used to endorse or promote products derived from this software without specific prior written permission.

THIS SOFTWARE IS PROVIDED BY THE PROJECT AND CONTRIBUTORS "AS IS" AND ANY EXPRESS OR IMPLIED WARRANTIES, INCLUDING, BUT NOT LIMITED TO, THE IMPLIED WARRANTIES OF MERCHANTABILITY AND FITNESS FOR A PARTICULAR PURPOSE ARE DISCLAIMED. IN NO EVENT SHALL THE PROJECT OR CONTRIBUTORS BE LIABLE FOR ANY DIRECT, INDIRECT, INCIDENTAL, SPECIAL, EXEMPLARY, OR CONSEQUENTIAL DAMAGES (INCLUDING, BUT NOT LIMITED TO, PROCUREMENT OF SUBSTITUTE GOODS OR SERVICES; LOSS OF USE, DATA, OR PROFITS; OR BUSINESS INTERRUPTION) HOWEVER CAUSED AND ON ANY THEORY OF LIABILITY, WHETHER IN CONTRACT, STRICT LIABILITY, OR TORT (INCLUDING NEGLIGENCE OR OTHERWISE) ARISING IN ANY WAY OUT OF THE USE OF THIS SOFTWARE, EVEN IF ADVISED OF THE POSSIBILITY OF SUCH DAMAGE.

Exhibit (H)

Copyright 2012 Query Foundation and other contributors
<http://query.com/>

Permission is hereby granted, free of charge, to any person obtaining a copy of this software and associated documentation files (the "Software"), to deal in the Software without restriction, including without limitation the rights to use, copy, modify, merge, publish, distribute, sublicense, and/or sell copies of the Software, and to permit persons to whom the Software is furnished to do so, subject to the following conditions:

The above copyright notice and this permission notice shall be included in all copies or substantial portions of the Software.

THE SOFTWARE IS PROVIDED "AS IS" WITHOUT WARRANTY OF ANY KIND, EXPRESS OR IMPLIED, INCLUDING BUT NOT LIMITED TO THE WARRANTIES OF MERCHANTABILITY, FITNESS FOR A PARTICULAR PURPOSE AND NONINFRINGEMENT. IN NO EVENT SHALL THE AUTHORS OR COPYRIGHT HOLDERS BE LIABLE FOR ANY CLAIM, DAMAGES OR OTHER LIABILITY, WHETHER IN AN ACTION OF CONTRACT, TORT OR OTHERWISE, ARISING FROM, OUT OF OR IN CONNECTION WITH THE SOFTWARE OR THE USE OR OTHER DEALINGS IN THE SOFTWARE.

Exhibit (I)

GNU LIBRARY GENERAL PUBLIC LICENSE Version 2, June 1991

Copyright (C) 1991 Free Software Foundation, Inc.
59 Temple Place - Suite 330, Boston, MA 02111-1307, USA
Everyone is permitted to copy and distribute verbatim copies of this license document, but changing it is not allowed.

[This is the first released version of the library GPL. It is numbered 2 because it goes with version 2 of the ordinary GPL.]

Preamble

The licenses for most software are designed to take away your freedom to share and change it. By contrast, the GNU General Public Licenses are intended to guarantee your freedom to share and change free software—to make sure the software is free for all its users.

This license, the Library General Public License, applies to some specially designated Free Software Foundation software, and to any other libraries whose authors decide to use it. You can use it for your libraries, too.

When we speak of free software, we are referring to freedom, not price. Our General Public Licenses are designed to make sure that you have the freedom to distribute copies of free software (and charge for this service if you wish), that you receive source code or can get it if you want it, that you can change the software or use pieces of it in new free programs; and that you know you can do these things.

To protect your rights, we need to make restrictions that forbid anyone to deny you these rights or to ask you to surrender the rights. These restrictions translate to certain responsibilities for you if you distribute copies of the library, or if you modify it.

For example, if you distribute copies of the library, whether gratis or for a fee, you must give the recipients all the rights that you gave us. You must make sure that they, too, receive or can get the source code. If you link a program with the library, you must provide complete object files to the recipients so that they can relink them with the library, after making changes to the library and recompiling it. And you must show them these terms so they know their rights.

Our method of protecting your rights has two steps: (1) copyright the library, and (2) offer you this license which gives you legal permission to copy, distribute and/or modify the library.

Also, for each distributor's protection, we want to make certain that everyone understands that there is no warranty for this free library. If the library is modified by someone else and passed on, we want its recipients to know that what they have is not the original version, so that any problems introduced by others will not reflect on the original authors' reputations.

Finally, any free program is threatened constantly by software patents. We wish to avoid the danger that companies distributing free software will individually obtain patent licenses, thus in effect transforming the program into proprietary software. To prevent this, we have made it clear

that any patent must be licensed for everyone's free use or not licensed at all.

Most GNU software, including some libraries, is covered by the ordinary GNU General Public License, which was designed for utility programs. This license, the GNU Library General Public License, applies to certain designated libraries. This license is quite different from the ordinary one; be sure to read it in full, and don't assume that anything in it is the same as in the ordinary license.

The reason we have a separate public license for some libraries is that they blur the distinction we usually make between modifying or adding to a program and simply using it. Linking a program with a library, without changing the library, is in some sense simply using the library, and is analogous to running a utility program or application program. However, in a textual and legal sense, the linked executable is a combined work, a derivative of the original library, and the ordinary General Public License treats it as such.

Because of this blurred distinction, using the ordinary General Public License for libraries did not effectively promote software sharing, because most developers did not use the libraries. We concluded that weaker conditions might promote sharing better.

However, unrestricted linking of non-free programs would deprive the users of those programs of all benefit from the free status of the libraries themselves. This Library General Public License is intended to permit developers of non-free programs to use free libraries, while preserving your freedom as a user of such programs to change the free libraries that are incorporated in them. (We have not seen how to achieve this as regards changes in header files, but we have achieved it as regards changes in the actual functions of the Library.) The hope is that this will lead to faster development of free libraries.

The precise terms and conditions for copying, distribution and modification follow. Pay close attention to the difference between a "work based on the library" and a "work that uses the library". The former contains code derived from the library, while the latter only works together with the library.

Note that it is possible for a library to be covered by the ordinary General Public License rather than by this special one.

GNU LIBRARY GENERAL PUBLIC LICENSE TERMS AND CONDITIONS FOR COPYING, DISTRIBUTION AND MODIFICATION

0. This License Agreement applies to any software library which contains a notice placed by the copyright holder or other authorized party saying it may be distributed under the terms of this Library General Public License (also called "this License"). Each licensee is addressed as "you".

A "library" means a collection of software functions and/or data prepared so as to be conveniently linked with application programs (which use some of those functions and data) to form executables.

The "Library", below, refers to any such software library or work which has been distributed under these terms. A "work based on the Library" means either the Library or any derivative work under copyright law; that is to say, a work containing the Library or a portion of it, either verbatim or with modifications and/or translated straightforwardly into another language. (Hereinafter, translation is included without limitation in the term "modification".)

"Source code" for a work means the preferred form of the work for making modifications to it. For a library, complete source code means all the source code for all modules it contains, plus any associated interface definition files, plus the scripts used to control compilation and installation of the library.

Activities other than copying, distribution and modification are not covered by this License; they are outside its scope. The act of running a program using the Library is not restricted, and output from such a program is covered only if its contents constitute a work based on the Library (independent of the use of the Library in a tool for writing it). Whether that is true depends on what the Library does and what the program that uses the Library does.

1. You may copy and distribute verbatim copies of the Library's complete source code as you receive it, in any medium, provided that you conspicuously and appropriately publish on each copy an appropriate copyright notice and disclaimer of warranty; keep intact all the notices that refer to this License and to the absence of any warranty; and distribute a copy of this License along with the Library.

You may charge a fee for the physical act of transferring a copy, and you may at your option offer warranty protection in exchange for a fee.

2. You may modify your copy or copies of the Library or any portion of it, thus forming a work based on the Library, and copy and distribute such modifications or work under the terms of Section 1 above, provided that you also meet all of these conditions:

a) The modified work must itself be a software library.

b) You must cause the files modified to carry prominent notices stating that you changed the files and the date of any change.

c) You must cause the whole of the work to be licensed at no charge to all third parties under the terms of this License.

d) If a facility in the modified Library refers to a function or a table of data to be supplied by an application program that uses the facility, other than as an argument passed when the facility is invoked, then you must make a good faith effort to ensure that, in the event an application does not supply such function or table, the facility still operates, and performs whatever part of its purpose remains meaningful.

(For example, a function in a library to compute square roots has a purpose that is entirely well-defined independent of the application. Therefore, Subsection 2d requires that any application-supplied function or table used by this function must be optional: if the application does not supply it, the square root function must still compute square roots.)

These requirements apply to the modified work as a whole. If identifiable sections of that work are not derived from the Library, and can be reasonably considered independent and separate works in themselves, then this License, and its terms, do not apply to those sections when you distribute them as separate works. But when you distribute the same sections as part of a whole which is a work based on the Library, the distribution of the whole must be on the terms of this License, whose permissions for other licensees extend to the entire whole, and thus to each and every part regardless of who wrote it.

Thus, it is not the intent of this section to claim rights or contest your rights to work written entirely by you; rather, the intent is to exercise the right to control the distribution of derivative or collective works based on the Library.

In addition, mere aggregation of another work not based on the Library with the Library (or with a work based on the Library) on a volume of a storage or distribution medium does not bring the other work under the scope of this License.

3. You may opt to apply the terms of the ordinary GNU General Public License instead of this License to a given copy of the Library. To do this, you must alter all the notices that refer to this License, so that they refer to the ordinary GNU General Public License, version 2, instead of to this License. (If a newer version than version 2 of the ordinary GNU General Public License has appeared, then you can specify that version instead if you wish.) Do not make any other change in these notices.

Once this change is made in a given copy, it is irreversible for that copy, so the ordinary GNU General Public License applies to all subsequent copies and derivative works made from that copy.

This option is useful when you wish to copy part of the code of the Library into a program that is not a library.

4. You may copy and distribute the Library (or a portion or derivative of it, under Section 2) in object code or executable form under the terms of Sections 1 and 2 above provided that you accompany it with the complete corresponding machine-readable source code, which must be distributed under the terms of Sections 1 and 2 above on a medium customarily used for software interchange.

If distribution of object code is made by offering access to copy from a designated place, then offering equivalent access to copy the source code from the same place satisfies the requirement to distribute the source code, even though third parties are not compelled to copy the source along with the object code.

5. A program that contains no derivative of any portion of the Library, but is designed to work with the Library by being compiled or linked with it, is called a "work that uses the Library". Such a work, in isolation, is not a derivative work of the Library, and therefore falls outside the scope of this License.

本機で使われるソフトウェアライセンス情報 (つづき)

However, linking a "work that uses the Library" with the Library creates an executable that is a derivative of the Library (because it contains portions of the Library), rather than a "work that uses the Library". The executable is therefore covered by this License. Section 6 states terms for distribution of such executables.

When a "work that uses the Library" uses material from a header file that is part of the Library, the object code for the work may be a derivative work of the Library even though the source code is not. Whether this is true is especially significant if the work can be linked without the Library, or if the work is itself a library. The threshold for this to be true is not precisely defined by law.

If such an object file uses only numerical parameters, data structure layouts and accessors, and small macros and small inline functions (ten lines or less in length), then the use of the object file is unrestricted, regardless of whether it is legally a derivative work. (Executables containing this object code plus portions of the Library will still fall under Section 6.)

Otherwise, if the work is a derivative of the Library, you may distribute the object code for the work under the terms of Section 6. Any executables containing that work also fall under Section 6, whether or not they are linked directly with the Library itself.

6. As an exception to the Sections above, you may also compile or link a "work that uses the Library" with the Library to produce a work containing portions of the Library, and distribute that work under terms of your choice, provided that the terms permit modification of the work for the customer's own use and reverse engineering for debugging such modifications.

You must give prominent notice with each copy of the work that the Library is used in it and that the Library and its use are covered by this License. You must supply a copy of this License. If the work during execution displays copyright notices, you must include the copyright notice for the Library among them, as well as a reference directing the user to the copy of this License. Also, you must do one of these things:

- a) Accompany the work with the complete corresponding machine-readable source code for the Library including whatever changes were used in the work (which must be distributed under Sections 1 and 2 above); and, if the work is an executable linked with the Library, with the complete machine-readable "work that uses the Library", as object code and/or source code, so that the user can modify the Library and then relink to produce a modified executable containing the modified Library. (It is understood that the user who changes the contents of definitions files in the Library will not necessarily be able to recompile the application to use the modified definitions.)

- b) Accompany the work with a written offer, valid for at least three years, to give the same user the materials specified in Subsection 6a, above, for a charge no more than the cost of performing this distribution.

- c) If distribution of the work is made by offering access to copy from a designated place, offer equivalent access to copy the above specified materials from the same place.

- d) Verify that the user has already received a copy of these materials or that you have already sent this user a copy.

For an executable, the required form of the "work that uses the Library" must include any data and utility programs needed for reproducing the executable from it. However, as a special exception, the source code distributed need not include anything that is normally distributed (in either source or binary form) with the major components (compiler, kernel, and so on) of the operating system on which the executable runs, unless that component itself accompanies the executable.

It may happen that this requirement contradicts the restrictions of other proprietary libraries that do not normally accompany the operating system. Such a contradiction means you cannot use both them and the Library together in an executable that you distribute.

7. You may place library facilities that are a work based on the Library side-by-side in a single library together with other library facilities not covered by this License, and distribute such a combined library, provided that the separate distribution of the work based on the Library and of the other library facilities is otherwise permitted, and provided that you do these two things:

- a) Accompany the combined library with a copy of the same work based on the Library, uncombined with any other library facilities. This must be distributed under the terms of the Sections above.

- b) Give prominent notice with the combined library of the fact that part of it is a work based on the Library, and explaining where to find the accompanying uncombined form of the same work.

8. You may not copy, modify, sublicense, link with, or distribute the Library except as expressly provided under this License. Any attempt otherwise to copy, modify, sublicense, link with, or distribute the Library is void, and will automatically terminate your rights under this License. However, parties who have received copies, or rights, from you under this License will not have their licenses terminated so long as such parties remain in full compliance.

9. You are not required to accept this License, since you have not signed it. However, nothing else grants you permission to modify or distribute the Library or its derivative works. These actions are prohibited by law if you do not accept this License. Therefore, by modifying or distributing the Library (or any work based on the Library), you indicate your acceptance of this License to do so, and all its terms and conditions for copying, distributing or modifying the Library or works based on it.

10. Each time you redistribute the Library (or any work based on the Library), the recipient automatically receives a license from the original licensor to copy, distribute, link with or modify the Library subject to the conditions of this License. You may not impose any further restrictions on the recipient's exercise of the rights granted herein. You are not responsible for enforcing compliance by third parties to this License.

11. If, as a consequence of a court judgment or allegation of patent infringement or for any other reason (not limited to patent issues), conditions are imposed on you (whether by court order, agreement or otherwise) that contradict the conditions of this License, they do not excuse you from the conditions of this License. If you cannot distribute so as to satisfy simultaneously your obligations under this License and any other pertinent obligations, then as a consequence you may not distribute the Library at all. For example, if a patent license would not permit royalty-free redistribution of the Library by all those who receive copies directly or indirectly through you, then the only way you could satisfy both it and this License would be to refrain entirely from distribution of the Library.

If any portion of this section is held invalid or unenforceable under any particular circumstance, the balance of the section is intended to apply, and the section as a whole is intended to apply in other circumstances.

It is not the purpose of this section to induce you to infringe any patents or other property right claims or to contest validity of any such claims; this section has the sole purpose of protecting the integrity of the free software distribution system which is implemented by public license practices. Many people have made generous contributions to the wide range of software distributed through that system in reliance on consistent application of that system; it is up to the author/donor to decide if he or she is willing to distribute software through any other system and a licensee cannot impose that choice.

This section is intended to make thoroughly clear what is believed to be a consequence of the rest of this License.

12. If the distribution and/or use of the Library is restricted in certain countries either by patents or by copyrighted interfaces, the original copyright holder who places the Library under this License may add an explicit geographical distribution limitation excluding those countries, so that distribution is permitted only in or among countries not thus excluded. In such case, this License incorporates the limitation as if written in the body of this License.

13. The Free Software Foundation may publish revised and/or new versions of the Library General Public License from time to time. Such new versions will be similar in spirit to the present version, but may differ in detail to address new problems or concerns.

Each version is given a distinguishing version number. If the Library specifies a version number of this License which applies to it and "any later version", you have the option of following the terms and conditions either of that version or of any later version published by the Free Software Foundation. If the Library does not specify a license version number, you may choose any version ever published by the Free Software Foundation.

14. If you wish to incorporate parts of the Library into other free programs whose distribution conditions are incompatible with these, write to the author to ask for permission. For software which is copyrighted by the Free Software Foundation, write to the Free Software Foundation; we sometimes make exceptions for this. Our decision will be guided by the two goals of preserving the free status of all derivatives of our free software and of promoting the sharing and reuse of software generally.

NO WARRANTY

15. BECAUSE THE LIBRARY IS LICENSED FREE OF CHARGE, THERE IS NO WARRANTY FOR THE LIBRARY, TO THE EXTENT PERMITTED BY APPLICABLE LAW. EXCEPT WHEN OTHERWISE STATED IN WRITING THE COPYRIGHT HOLDERS AND/OR OTHER PARTIES PROVIDE THE LIBRARY "AS IS" WITHOUT WARRANTY OF ANY KIND, EITHER EXPRESSED OR IMPLIED, INCLUDING, BUT NOT LIMITED TO, THE IMPLIED WARRANTIES OF MERCHANTABILITY AND FITNESS FOR A PARTICULAR PURPOSE. THE ENTIRE RISK AS TO THE QUALITY AND PERFORMANCE OF THE LIBRARY IS WITH YOU. SHOULD THE LIBRARY PROVE DEFECTIVE, YOU ASSUME THE COST OF ALL NECESSARY SERVICING, REPAIR OR CORRECTION.

16. IN NO EVENT UNLESS REQUIRED BY APPLICABLE LAW OR AGREED TO IN WRITING WILL ANY COPYRIGHT HOLDER, OR ANY OTHER PARTY WHO MAY MODIFY AND/OR REDISTRIBUTE THE LIBRARY AS PERMITTED ABOVE, BE LIABLE TO YOU FOR DAMAGES, INCLUDING ANY GENERAL, SPECIAL, INCIDENTAL OR CONSEQUENTIAL DAMAGES ARISING OUT OF THE USE OR INABILITY TO USE THE LIBRARY (INCLUDING BUT NOT LIMITED TO LOSS OF DATA OR DATA BEING RENDERED INACCURATE OR LOSSES SUSTAINED BY YOU OR THIRD PARTIES OR A FAILURE OF THE LIBRARY TO OPERATE WITH ANY OTHER SOFTWARE), EVEN IF SUCH HOLDER OR OTHER PARTY HAS BEEN ADVISED OF THE POSSIBILITY OF SUCH DAMAGES.

END OF TERMS AND CONDITIONS

Appendix: How to Apply These Terms to Your New Libraries

If you develop a new library, and you want it to be of the greatest possible use to the public, we recommend making it free software that everyone can redistribute and change. You can do so by permitting redistribution under these terms (or, alternatively, under the terms of the ordinary General Public License).

To apply these terms, attach the following notices to the library. It is safest to attach them to the start of each source file to most effectively convey the exclusion of warranty; and each file should have at least the "copyright" line and a pointer to where the full notice is found.

```
<one line to give the library's name and a brief idea of what it does.>
Copyright (C) <year> <name of author>
```

This library is free software; you can redistribute it and/or modify it under the terms of the GNU Library General Public License as published by the Free Software Foundation; either version 2 of the License, or (at your option) any later version.

This library is distributed in the hope that it will be useful, but WITHOUT ANY WARRANTY; without even the implied warranty of MERCHANTABILITY or FITNESS FOR A PARTICULAR PURPOSE. See the GNU Library General Public License for more details.

You should have received a copy of the GNU Library General Public License along with this library; if not, write to the Free Software Foundation, Inc., 59 Temple Place - Suite 330, Boston, MA 02111-1307, USA

Also add information on how to contact you by electronic and paper mail.

You should also get your employer (if you work as a programmer) or your school, if any, to sign a "copyright disclaimer" for the library, if necessary. Here is a sample; alter the names:

```
Yoodyne, Inc, hereby disclaims all copyright interest in the
library 'Frob' (a library for tweaking knobs) written by James Random Hacker.
```

```
<signature of Ty Coon>, 1 April 1990
Ty Coon, President of Vice
```

That's all there is to it!

Exhibit (J)

GNU LIBRARY GENERAL PUBLIC LICENSE Version 2, June 1991

Copyright (C) 1991 Free Software Foundation, Inc.
675 Mass Ave, Cambridge, MA 02139, USA
Everyone is permitted to copy and distribute verbatim copies of this license document, but changing it is not allowed.

[This is the first released version of the library GPL. It is numbered 2 because it goes with version 2 of the ordinary GPL.]

Preamble

The licenses for most software are designed to take away your freedom to share and change it. By contrast, the GNU General Public Licenses are intended to guarantee your freedom to share and change free software—to make sure the software is free for all its users.

This license, the Library General Public License, applies to some specially designated Free Software Foundation software, and to any other libraries whose authors decide to use it. You can use it for your libraries, too.

When we speak of free software, we are referring to freedom, not price. Our General Public Licenses are designed to make sure that you have the freedom to distribute copies of free software (and charge for this service if you wish), that you receive source code or can get it if you want it, that you can change the software or use pieces of it in new free programs; and that you know you can do these things.

To protect your rights, we need to make restrictions that forbid anyone to deny you these rights or to ask you to surrender the rights. These restrictions translate to certain responsibilities for you if you distribute copies of the library, or if you modify it.

For example, if you distribute copies of the library, whether gratis or for a fee, you must give the recipients all the rights that we gave you. You must make sure that they, too, receive or can get the source code. If you link a program with the library, you must provide complete object files to the recipients so that they can relink them with the library, after making changes to the library and recompiling it. And you must show them these terms so they know their rights.

Our method of protecting your rights has two steps: (1) copyright the library, and (2) offer you this license which gives you legal permission to copy, distribute and/or modify the library.

Also, for each distributor's protection, we want to make certain that everyone understands that there is no warranty for this free library. If the library is modified by someone else and passed on, we want its recipients to know that what they have is not the original version, so that any problems introduced by others will not reflect on the original authors' reputations.

Finally, any free program is threatened constantly by software patents. We wish to avoid the danger that companies distributing free software will individually obtain patent licenses, thus in effect transforming the program into proprietary software. To prevent this, we have made it clear that any patent must be licensed for everyone's free use or not licensed at all.

Most GNU software, including some libraries, is covered by the ordinary GNU General Public License, which was designed for utility programs. This license, the GNU Library General Public License, applies to running a utility program or application program. However, in a textual and legal sense, the linked executable is a combined work, a derivative of the original library, and the ordinary General Public License treats it as such.

The reason we have a separate public license for some libraries is that they blur the distinction we usually make between modifying or adding to a program and simply using it. Linking a program with a library, without changing the library, is in some sense simply using the library, and is analogous to running a utility program or application program. However, in a textual and legal sense, the linked executable is a combined work, a derivative of the original library, and the ordinary General Public License treats it as such.

Because of this blurred distinction, using the ordinary General Public License for libraries did not effectively promote software sharing, because most developers did not use the libraries. We concluded that weaker conditions might promote sharing better.

However, unrestricted linking of non-free programs would deprive the users of those programs of all benefit from the free status of the libraries themselves. This Library General Public License is intended to permit developers of non-free programs to use free libraries, while preserving your freedom as a user of such programs to change the free libraries that are incorporated in them. (We have not seen how to achieve this as regards changes in header files, but we have achieved it as regards changes in the actual functions of the Library.) The hope is that this will lead to faster

development of free libraries.

The precise terms and conditions for copying, distribution and modification follow. Pay close attention to the difference between a "work based on the library" and a "work that uses the library". The former contains code derived from the library, while the latter only works together with the library.

Note that it is possible for a library to be covered by the ordinary General Public License rather than by this special one.

GNU LIBRARY GENERAL PUBLIC LICENSE TERMS AND CONDITIONS FOR COPYING, DISTRIBUTION AND MODIFICATION

0. This License Agreement applies to any software library which contains a notice placed by the copyright holder or other authorized party saying it may be distributed under the terms of this Library General Public License (also called "this License"). Each licensee is addressed as "you".

A "library" means a collection of software functions and/or data prepared so as to be conveniently linked with application programs (which use some of those functions and data) to form executables.

The "Library", below, refers to any such software library or work which has been distributed under these terms. A "work based on the Library" means either the Library or any derivative work under copyright law: that is to say, a work containing the Library or a portion of it, either verbatim or with modifications and/or translated straightforwardly into another language. (Hereinafter, translation is included without limitation in the term "modification".)

"Source code" for a work means the preferred form of the work for making modifications to it. For a library, complete source code means all the source code for all modules it contains, plus any associated interface definition files, plus the scripts used to control compilation and installation of the library.

Activities other than copying, distribution and modification are not covered by this License; they are outside its scope. The act of running a program using the Library is not restricted, and output from such a program is covered only if its contents constitute a work based on the Library (independent of the use of the Library in a tool for writing it). Whether that is true depends on what the Library does and what the program that uses the Library does.

1. You may copy and distribute verbatim copies of the Library's complete source code as you receive it, in any medium, provided that you conspicuously and appropriately publish on each copy an appropriate copyright notice and disclaimer of warranty; keep intact all the notices that refer to this License and to the absence of any warranty; and distribute a copy of this License along with the Library.

You may charge a fee for the physical act of transferring a copy, and you may at your option offer warranty protection in exchange for a fee.

2. You may modify your copy or copies of the Library or any portion of it, thus forming a work based on the Library, and copy and distribute such modifications or work under the terms of Section 1 above, provided that you also meet all of these conditions:

- a) The modified work must itself be a software library.
- b) You must cause the files modified to carry prominent notices stating that you changed the files and the date of any change.
- c) You must cause the whole of the work to be licensed at no charge to all third parties under the terms of this License.
- d) If a facility in the modified Library refers to a function or a table of data to be supplied by an application program that uses the facility, other than as an argument passed when the facility is invoked, then you must make a good faith effort to ensure that, in the event an application does not supply such function or table, the facility still operates, and performs whatever part of its purpose remains meaningful.

(For example, a function in a library to compute square roots has a purpose that is entirely well-defined independent of the application. Therefore, Subsection 2d requires that any application-supplied function or table used by this function must be optional: if the application does not supply it, the square root function must still compute square roots.)

These requirements apply to the modified work as a whole. If identifiable sections of that work are not derived from the Library, and can be reasonably considered independent and separate works in themselves, then this License, and its terms, do not apply to those sections when you distribute them as separate works. But when you distribute the same sections as part of a whole which is a work based on the Library, the distribution of the whole must be on the terms of this License, whose permissions for other licensees extend to the entire whole, and thus to each and every part regardless of who wrote it.

Thus, it is not the intent of this section to claim rights or contest your rights to work written entirely by you; rather, the intent is to exercise the right to control the distribution of derivative or collective works based on the Library.

In addition, mere aggregation of another work not based on the Library with the Library (or with a work based on the Library) on a volume of a storage or distribution medium does not bring the other work under the scope of this License.

3. You may opt to apply the terms of the ordinary GNU General Public License instead of this License to a given copy of the Library. To do this, you must alter all the notices that refer to this License, so that they refer to the ordinary GNU General Public License, version 2, instead of to this License. (If a newer version than version 2 of the ordinary GNU General Public License has appeared, then you can specify that version instead if you wish.) Do not make any other change in these notices.

Once this change is made in a given copy, it is irreversible for that copy, so the ordinary GNU General Public License applies to all subsequent copies and derivative works made from that copy.

This option is useful when you wish to copy part of the code of the Library into a program that is not a library.

4. You may copy and distribute the Library (or a portion or derivative of it, under Section 2) in object code or executable form under the terms of Sections 1 and 2 above provided that you accompany it with the complete corresponding machine-readable source code, which must be distributed under the terms of Sections 1 and 2 above on a medium customarily used for software interchange.

If distribution of object code is made by offering access to copy from a designated place, then offering equivalent access to copy the source code from the same place satisfies the requirement to distribute the source code, even though third parties are not compelled to copy the source along with the object code.

5. A program that contains no derivative of any portion of the Library, but is designed to work with the Library by being compiled or linked with it, is called a "work that uses the Library". Such a work, in isolation, is not a derivative work of the Library, and therefore falls outside the scope of this License.

However, linking a "work that uses the Library" with the Library creates an executable that is a derivative of the Library (because it contains portions of the Library), rather than a "work that uses the library". The executable is therefore covered by this License. Section 6 states terms for distribution of such executables.

When a "work that uses the Library" uses material from a header file that is part of the Library, the object code for the work may be a derivative work of the Library even though the source code is not. Whether this is true is especially significant if the work can be linked without the Library, or if the work is itself a library. The threshold for this to be true is not precisely defined by law.

If such an object file uses only numerical parameters, data structure layouts and accessors, and small macros and small inline functions (ten lines or less in length), then the use of the object file is unrestricted, regardless of whether it is legally a derivative work. (Executables containing this object code plus portions of the Library will still fall under Section 6.)

Otherwise, if the work is a derivative of the Library, you may distribute the object code for the work under the terms of Section 6. Any executables containing that work also fall under Section 6, whether or not they are linked directly with the Library itself.

6. As an exception to the Sections above, you may also compile or link a "work that uses the Library" with the Library to produce a work containing portions of the Library, and distribute that work under terms of your choice, provided that the terms permit modification of the work for the customer's own use and reverse engineering for debugging such modifications.

You must give prominent notice with each copy of the work that the Library is used in it and that

the Library and its use are covered by this License. You must supply a copy of this License. If the work during execution displays copyright notices, you must include the copyright notice for the Library among them, as well as a reference directing the user to the copy of this License. Also, you must do one of these things:

- a) Accompany the work with the complete corresponding machine-readable source code for the Library including whatever changes were used in the work (which must be distributed under Sections 1 and 2 above); and, if the work is an executable linked with the Library, with the complete machine-readable "work that uses the Library", as object code and/or source code, so that the user can modify the Library and then relink to produce a modified executable containing the modified Library. (It is understood that the user who changes the contents of definition files in the Library will not necessarily be able to recompile the application to use the modified definitions.)
- b) Accompany the work with a written offer, valid for at least three years, to give the same user the materials specified in Subsection 6a, above, for a charge no more than the cost of performing this distribution.
- c) If distribution of the work is made by offering access to copy from a designated place, offer equivalent access to copy the above specified materials from the same place.
- d) Verify that the user has already received a copy of these materials or that you have already sent this user a copy.

For an executable, the required form of the "work that uses the Library" must include any data and utility programs needed for reproducing the executable from it. However, as a special exception, the source code distributed need not include anything that is normally distributed (in either source or binary form) with the major components (compiler, kernel, and so on) of the operating system on which the executable runs, unless that component itself accompanies the executable.

It may happen that this requirement contradicts the license restrictions of other proprietary libraries that do not normally accompany the operating system. Such a contradiction means you cannot use both them and the Library together in an executable that you distribute.

7. You may place library facilities that are a work based on the Library side-by-side in a single library together with other library facilities not covered by this License, and distribute such a combined library, provided that the separate distribution of the work based on the Library and of the other library facilities is otherwise permitted, and provided that you do these two things:

- a) Accompany the combined library with a copy of the same work based on the Library, uncombined with any other library facilities. This must be distributed under the terms of the Sections above.
- b) Give prominent notice with the combined library of the fact that part of it is a work based on the Library, and explaining where to find the accompanying uncombined form of the same work.

8. You may not copy, modify, sublicense, link with, or distribute the Library except as expressly provided under this License. Any attempt otherwise to copy, modify, sublicense, link with, or distribute the Library is void, and will automatically terminate your rights under this License. However, parties who have received copies, or rights, from you under this License will not have their licenses terminated so long as such parties remain in full compliance.

9. You are not required to accept this License, since you have not signed it. However, nothing else grants you permission to modify or distribute the Library or its derivative works. These actions are prohibited by law if you do not accept this License. Therefore, by modifying or distributing the Library (or any work based on the Library), you indicate your acceptance of this License to do so, and all its terms and conditions for copying, distributing or modifying the Library or works based on it.

10. Each time you redistribute the Library (or any work based on the Library), the recipient automatically receives a license from the original licensor to copy, distribute, link with or modify the Library subject to these terms and conditions. You may not impose any further restrictions on the recipients' exercise of the rights granted herein. You are not responsible for enforcing compliance by third parties to this License.

11. If, as a consequence of a court judgment or allegation of patent infringement or for any other reason (not limited to patent issues), conditions are imposed on you (whether by court order, agreement or otherwise) that contradict the conditions of this License, they do not excuse you from the conditions of this License. If you cannot distribute so as to satisfy simultaneously your obligations under this License and any other pertinent obligations, then as a consequence you may not distribute the Library at all. For example, if a patent license would not permit royalty-free redistribution of the Library by all those who receive copies directly or indirectly through you, then the only way you could satisfy both it and this License would be to refrain entirely from distribution of the Library.

If any portion of this section is held invalid or unenforceable under any particular circumstance, the balance of the section is intended to apply, and the section as a whole is intended to apply in other circumstances.

It is not the purpose of this section to induce you to infringe any patents or other property right claims or to contest validity of any such claims; this section has the sole purpose of protecting the integrity of the free software distribution system which is implemented by public license practices. Many people have made generous contributions to the wide range of software distributed through that system in reliance on consistent application of that system; it is up to the author/donor to decide if he or she is willing to distribute software through any other system and a licensee cannot impose that choice.

This section is intended to make thoroughly clear what is believed to be a consequence of the rest of this License.

12. If the distribution and/or use of the Library is restricted in certain countries either by patents or by copyrighted interfaces, the original copyright holder who places the Library under this License may add an explicit geographical distribution limitation excluding those countries, so that distribution is permitted only in or among countries not thus excluded. In such case, this License incorporates the limitation as if written in the body of this License.

13. The Free Software Foundation may publish revised and/or new versions of the Library General Public License from time to time. Such new versions will be similar in spirit to the present version, but may differ in detail to address new problems or concerns.

Each version is given a distinguishing version number. If the Library specifies a version number of this License which applies to it and "any later version", you have the option of following the terms and conditions either of that version or of any later version published by the Free Software Foundation. If the Library does not specify a license version number, you may choose any version ever published by the Free Software Foundation.

14. If you wish to incorporate parts of the Library into other free programs whose distribution conditions are incompatible with these, write to the author to ask for permission. For software which is copyrighted by the Free Software Foundation, write to the Free Software Foundation; we sometimes make exceptions for this. Our decision will be guided by the two goals of preserving the free status of all derivatives of our free software and of promoting the sharing and reuse of software generally.

NO WARRANTY

15. BECAUSE THE LIBRARY IS LICENSED FREE OF CHARGE, THERE IS NO WARRANTY FOR THE LIBRARY, TO THE EXTENT PERMITTED BY APPLICABLE LAW. EXCEPT WHEN OTHERWISE STATED IN WRITING THE COPYRIGHT HOLDERS AND/OR OTHER PARTIES PROVIDE THE LIBRARY "AS IS" WITHOUT WARRANTY OF ANY KIND, EITHER EXPRESSED OR IMPLIED, INCLUDING, BUT NOT LIMITED TO, THE IMPLIED WARRANTIES OF MERCHANTABILITY AND FITNESS FOR A PARTICULAR PURPOSE. THE ENTIRE RISK AS TO THE QUALITY AND PERFORMANCE OF THE LIBRARY IS WITH YOU. SHOULD THE LIBRARY PROVE DEFECTIVE, YOU ASSUME THE COST OF ALL NECESSARY SERVICING, REPAIR OR CORRECTION.

16. IN NO EVENT UNLESS REQUIRED BY APPLICABLE LAW OR AGREED TO IN WRITING WILL ANY COPYRIGHT HOLDER, OR ANY OTHER PARTY WHO MAY MODIFY AND/OR REDISTRIBUTE THE LIBRARY AS PERMITTED ABOVE, BE LIABLE TO YOU FOR DAMAGES, INCLUDING ANY GENERAL, SPECIAL, INCIDENTAL OR CONSEQUENTIAL DAMAGES ARISING OUT OF THE USE OR INABILITY TO USE THE LIBRARY (INCLUDING BUT NOT LIMITED TO LOSS OF DATA OR DATA BEING RENDERED INACCURATE OR LOSSES SUSTAINED BY YOU OR THIRD PARTIES OR A FAILURE OF THE LIBRARY TO OPERATE WITH ANY OTHER SOFTWARE), EVEN IF SUCH HOLDER OR OTHER PARTY HAS BEEN ADVISED OF THE POSSIBILITY OF SUCH DAMAGES.

END OF TERMS AND CONDITIONS

Appendix: How to Apply These Terms to Your New Libraries

If you develop a new library, and you want it to be of the greatest possible use to the public, we recommend making it free software that everyone can redistribute and change. You can do so by permitting redistribution under these terms (or, alternatively, under the terms of the ordinary

本機で使われるソフトウェアライセンス情報 (つづき)

General Public License).

To apply these terms, attach the following notices to the library. It is safest to attach them to the start of each source file to most effectively convey the exclusion of warranty; and each file should have at least the "copyright" line and a pointer to where the full notice is found.

```
<one line to give the library's name and a brief idea of what it does.>
Copyright (C) <year> <name of author>
```

This library is free software; you can redistribute it and/or modify it under the terms of the GNU Library General Public License as published by the Free Software Foundation; either version 2 of the License, or (at your option) any later version.

This library is distributed in the hope that it will be useful, but WITHOUT ANY WARRANTY; without even the implied warranty of MERCHANTABILITY or FITNESS FOR A PARTICULAR PURPOSE. See the GNU Library General Public License for more details.

You should have received a copy of the GNU Library General Public License along with this library; if not, write to the Free Software Foundation, Inc., 675 Mass Ave, Cambridge, MA 02139, USA.

Also add information on how to contact you by electronic and paper mail.

You should also get your employer (if you work as a programmer) or your school, if any, to sign a "copyright disclaimer" for the library, if necessary. Here is a sample; alter the names:

```
Yoyodyne, Inc., hereby disclaims all copyright interest in the library 'Frob' (a library for tweaking knobs)
written by James Random Hacker.
```

```
<signature of Ty Coon>, 1 April 1990
Ty Coon, President of Vice
```

That's all there is to it!

Exhibit (K)

The FreeType 2 font engine is copyrighted work and cannot be used legally without a software license. In order to make this project usable to a vast majority of developers, we distribute it under two mutually exclusive open-source licenses.

This means that "you" must choose "one" of the two licenses described below, then obey all its terms and conditions when using FreeType 2 in any of your projects or products.

- The FreeType License, found in the file 'FTL.TXT', which is similar to the original BSD license *with* an advertising clause that forces you to explicitly cite the FreeType project in your product's documentation. All details are in the license file. This license is suited to products which don't use the GNU General Public License.

Note that this license is compatible to the GNU General Public License version 3, but not version 2.

- The GNU General Public License version 2, found in 'GPLv2.TXT' (any later version can be used also), for programs which already use the GPL. Note that the FTL is incompatible with GPLv2 due to its advertisement clause.

The contributed BDF and PCF drivers come with a license similar to that of the X Window System. It is compatible to the above two licenses (see file src/bdf/README and src/pcf/README).

The gzip module uses the zlib license (see src/gzip/zlib.h) which too is compatible to the above two licenses.

The MD5 checksum support (only used for debugging in development builds) is in the public domain.

Exhibit (L)

LICENSE ISSUES

The OpenSSL toolkit stays under a double license, i.e. both the conditions of the OpenSSL License and the original SSLeay license apply to the toolkit. See below for the actual license texts. Actually both licenses are BSD-style Open Source licenses. In case of any license issues related to OpenSSL please contact openssl-core@openssl.org.

OpenSSL License

```
/* =====
 * Copyright (c) 1998-2018 The OpenSSL Project. All rights reserved.
 *
 * Redistribution and use in source and binary forms, with or without
 * modification, are permitted provided that the following conditions
 * are met:
 *
 * 1. Redistributions of source code must retain the above copyright
 * notice, this list of conditions and the following disclaimer.
 *
 * 2. Redistributions in binary form must reproduce the above copyright
 * notice, this list of conditions and the following disclaimer in the
 * documentation and/or other materials provided with the
 * distribution.
 *
 * 3. All advertising materials mentioning features or use of this
 * software must display the following acknowledgment:
 * This product includes software developed by the OpenSSL Project
 * for use in the OpenSSL Toolkit. (http://www.openssl.org/)
 *
 * 4. The names "OpenSSL Toolkit" and "OpenSSL Project" must not be used to
 * endorse or promote products derived from this software without
 * prior written permission. For written permission, please contact
 * openssl-core@openssl.org.
 *
 * 5. Products derived from this software may not be called "OpenSSL"
 * nor may "OpenSSL" appear in their names without prior written
 * permission of the OpenSSL Project.
 *
 * 6. Redistributions of any form whatsoever must retain the following
 * acknowledgment:
 * This product includes software developed by the OpenSSL Project
 * for use in the OpenSSL Toolkit (http://www.openssl.org/)
 *
 * THIS SOFTWARE IS PROVIDED BY THE OPENSSL PROJECT "AS IS" AND ANY
 * EXPRESSED OR IMPLIED WARRANTIES, INCLUDING, BUT NOT LIMITED TO, THE
 * IMPLIED WARRANTIES OF MERCHANTABILITY AND FITNESS FOR A PARTICULAR
 * PURPOSE ARE DISCLAIMED. IN NO EVENT SHALL THE OPENSSL PROJECT OR
 * ITS CONTRIBUTORS BE LIABLE FOR ANY DIRECT, INDIRECT, INCIDENTAL,
 * SPECIAL, EXEMPLARY, OR CONSEQUENTIAL DAMAGES (INCLUDING, BUT
 * NOT LIMITED TO, PROCUREMENT OF SUBSTITUTE GOODS OR SERVICES;
 * LOSS OF USE, DATA, OR PROFITS; OR BUSINESS INTERRUPTION)
 * HOWEVER CAUSED AND ON ANY THEORY OF LIABILITY, WHETHER IN CONTRACT,
 * STRICT LIABILITY, OR TORT (INCLUDING NEGLIGENCE OR OTHERWISE)
 * ARISING IN ANY WAY OUT OF THE USE OF THIS SOFTWARE, EVEN IF ADVISED
 * OF THE POSSIBILITY OF SUCH DAMAGE.
 * =====
 */
```

```
* This product includes cryptographic software written by Eric Young
* (eay@cryptsoft.com). This product includes software written by Tim
* Hudson (tjh@cryptsoft.com).
*/
```

Original SSLeay License

```
/* Copyright (C) 1995-1998 Eric Young (eay@cryptsoft.com)
 * All rights reserved.
 *
 * This package is an SSL implementation written
 * by Eric Young (eay@cryptsoft.com).
 * The implementation was written so as to conform with Netscapes SSL.
 *
 * This library is free for commercial and non-commercial use as long as
 * the following conditions are aheared to. The following conditions
 * apply to all code found in this distribution, be it the RC4, RSA,
 * lhash, DES, etc., code; not just the SSL code. The SSL documentation
 * included with this distribution is covered by the same copyright terms
 * except that the holder is Tim Hudson (tjh@cryptsoft.com).
 *
 * Copyright remains Eric Young's, and as such any Copyright notices in
 * the code are not to be removed.
 * If this package is used in a product, Eric Young should be given attribution
 * as the author of the parts of the library used.
 * This can be in the form of a textual message at program startup or
 * in documentation (online or textual) provided with the package.
 *
 * Redistribution and use in source and binary forms, with or without
 * modification, are permitted provided that the following conditions
 * are met:
 * 1. Redistributions of source code must retain the copyright
 * notice, this list of conditions and the following disclaimer.
 * 2. Redistributions in binary form must reproduce the above copyright
 * notice, this list of conditions and the following disclaimer in the
 * documentation and/or other materials provided with the distribution.
 * 3. All advertising materials mentioning features or use of this software
 * must display the following acknowledgement:
 * This product includes cryptographic software written by
 * Eric Young (eay@cryptsoft.com)
 * The word "cryptographic" can be left out if the routines from the library
 * being used are not cryptographic related (-).
 * 4. If you include any Windows specific code (or a derivative thereof) from
 * the apps directory (application code) you must include an acknowledgement:
 * This product includes software written by Tim Hudson (tjh@cryptsoft.com)
 *
 * THIS SOFTWARE IS PROVIDED BY ERIC YOUNG "AS IS" AND
 * ANY EXPRESS OR IMPLIED WARRANTIES, INCLUDING, BUT NOT LIMITED TO, THE
 * IMPLIED WARRANTIES OF MERCHANTABILITY AND FITNESS FOR A PARTICULAR PURPOSE
 * ARE DISCLAIMED. IN NO EVENT SHALL THE AUTHOR OR CONTRIBUTORS BE LIABLE
 * FOR ANY DIRECT, INDIRECT, INCIDENTAL, SPECIAL, EXEMPLARY, OR CONSEQUENTIAL
 * DAMAGES (INCLUDING, BUT NOT LIMITED TO, PROCUREMENT OF SUBSTITUTE GOODS
 * OR SERVICES; LOSS OF USE, DATA, OR PROFITS; OR BUSINESS INTERRUPTION)
 * HOWEVER CAUSED AND ON ANY THEORY OF LIABILITY, WHETHER IN CONTRACT, STRICT
 * LIABILITY, OR TORT (INCLUDING NEGLIGENCE OR OTHERWISE) ARISING IN ANY WAY
 * OUT OF THE USE OF THIS SOFTWARE, EVEN IF ADVISED OF THE POSSIBILITY OF
 * SUCH DAMAGE.
 *
 * The licence and distribution terms for any publically available version or
 * derivative of this code cannot be changed, i.e. this code cannot simply be
 * copied and put under another distribution licence
 * [including the GNU Public Licence.]
 */
```

Exhibit (M)

```
/* Copyright (c) 2004-2010 Sergey Lyubka
 *
 * Permission is hereby granted, free of charge, to any person obtaining a copy
 * of this software and associated documentation files (the "Software"), to deal
 * in the Software without restriction, including without limitation the rights
 * to use, copy, modify, merge, publish, distribute, sublicense, and/or sell
 * copies of the Software, and to permit persons to whom the Software is
 * furnished to do so, subject to the following conditions:
 *
 * The above copyright notice and this permission notice shall be included in
 * all copies or substantial portions of the Software.
 *
 * THE SOFTWARE IS PROVIDED "AS IS", WITHOUT WARRANTY OF ANY KIND, EXPRESS OR
 * IMPLIED, INCLUDING BUT NOT LIMITED TO THE WARRANTIES OF MERCHANTABILITY,
 * FITNESS FOR A PARTICULAR PURPOSE AND NONINFRINGEMENT. IN NO EVENT SHALL
 * AUTHORS OR COPYRIGHT HOLDERS BE LIABLE FOR ANY CLAIM, DAMAGES OR OTHER
 * LIABILITY, WHETHER IN AN ACTION OF CONTRACT, TORT OR OTHERWISE, ARISING FROM,
 * OUT OF OR IN CONNECTION WITH THE SOFTWARE OR THE USE OR OTHER DEALINGS IN
 * THE SOFTWARE.
```

Exhibit (N)

Copyright (c) 2002-2014, Jouni Malinen <j@w1.fi> and contributors All Rights Reserved.

Redistribution and use in source and binary forms, with or without modification, are permitted provided that the following conditions are met:

1. Redistributions of source code must retain the above copyright notice, this list of conditions and the following disclaimer.
2. Redistributions in binary form must reproduce the above copyright notice, this list of conditions and the following disclaimer in the documentation and/or other materials provided with the distribution.
3. Neither the name(s) of the above-listed copyright holder(s) nor the names of its contributors may be used to endorse or promote products derived from this software without specific prior written permission.

THIS SOFTWARE IS PROVIDED BY THE COPYRIGHT HOLDERS AND CONTRIBUTORS "AS IS" AND ANY EXPRESS OR IMPLIED WARRANTIES, INCLUDING, BUT NOT LIMITED TO, THE IMPLIED WARRANTIES OF MERCHANTABILITY AND FITNESS FOR A PARTICULAR PURPOSE ARE DISCLAIMED. IN NO EVENT SHALL THE COPYRIGHT OWNER OR CONTRIBUTORS BE LIABLE FOR ANY DIRECT, INDIRECT, INCIDENTAL, SPECIAL, EXEMPLARY, OR CONSEQUENTIAL DAMAGES (INCLUDING, BUT NOT LIMITED TO, PROCUREMENT OF SUBSTITUTE GOODS OR SERVICES; LOSS OF USE, DATA, OR PROFITS; OR BUSINESS INTERRUPTION) HOWEVER CAUSED AND ON ANY THEORY OF LIABILITY, WHETHER IN CONTRACT, STRICT LIABILITY, OR TORT (INCLUDING NEGLIGENCE OR OTHERWISE) ARISING IN ANY WAY OUT OF THE USE OF THIS SOFTWARE, EVEN IF ADVISED OF THE POSSIBILITY OF SUCH DAMAGE.

Exhibit (O)

The author of this software is David M. Gay.

Copyright (C) 1998 by Lucent Technologies All Rights Reserved

Permission to use, copy, modify, and distribute this software and its documentation for any purpose and without fee is hereby granted, provided that the above copyright notice appear in all copies and that both that the copyright notice and this permission notice and warranty disclaimer appear in supporting documentation, and that the name of Lucent or any of its entities not be used in advertising or publicity pertaining to distribution of the software without specific, written prior permission.

LUCENT DISCLAIMS ALL WARRANTIES WITH REGARD TO THIS SOFTWARE, INCLUDING ALL IMPLIED WARRANTIES OF MERCHANTABILITY AND FITNESS. IN NO EVENT SHALL LUCENT OR ANY OF ITS ENTITIES BE LIABLE FOR ANY SPECIAL, INDIRECT OR CONSEQUENTIAL DAMAGES OR ANY DAMAGES WHATSOEVER RESULTING FROM LOSS OF USE, DATA OR PROFITS, WHETHER IN AN ACTION OF CONTRACT, NEGLIGENCE OR OTHER TORTIOUS ACTION, ARISING OUT OF OR IN CONNECTION WITH THE USE OR PERFORMANCE OF THIS SOFTWARE.

Exhibit (P)

Copyright (c) 2009 Dave Gamble

Permission is hereby granted, free of charge, to any person obtaining a copy of this software and associated documentation files (the "Software"), to deal in the Software without restriction, including without limitation the rights to use, copy, modify, merge, publish, distribute, sublicense, and/or sell copies of the Software, and to permit persons to whom the Software is furnished to do so, subject to the following conditions:

The above copyright notice and this permission notice shall be included in all copies or substantial portions of the Software.

THE SOFTWARE IS PROVIDED "AS IS", WITHOUT WARRANTY OF ANY KIND, EXPRESS OR IMPLIED, INCLUDING BUT NOT LIMITED TO THE WARRANTIES OF MERCHANTABILITY, FITNESS FOR A PARTICULAR PURPOSE AND NONINFRINGEMENT. IN NO EVENT SHALL THE AUTHORS OR COPYRIGHT HOLDERS BE LIABLE FOR ANY CLAIM, DAMAGES OR OTHER LIABILITY, WHETHER IN AN ACTION OF CONTRACT, TORT OR OTHERWISE, ARISING FROM, OUT OF OR IN CONNECTION WITH THE SOFTWARE OR THE USE OR OTHER DEALINGS IN THE SOFTWARE.

Exhibit (Q)

Copyright (c) 1998-2000 Thai Open Source Software Center Ltd and Clark Cooper
Copyright (c) 2001-2016 Expat maintainers

Permission is hereby granted, free of charge, to any person obtaining a copy of this software and associated documentation files (the "Software"), to deal in the Software without restriction, including without limitation the rights to use, copy, modify, merge, publish, distribute, sublicense, and/or sell copies of the Software, and to permit persons to whom the Software is furnished to do so, subject to the following conditions:

The above copyright notice and this permission notice shall be included in all copies or substantial portions of the Software.

THE SOFTWARE IS PROVIDED "AS IS", WITHOUT WARRANTY OF ANY KIND, EXPRESS OR IMPLIED, INCLUDING BUT NOT LIMITED TO THE WARRANTIES OF MERCHANTABILITY, FITNESS FOR A PARTICULAR PURPOSE AND NONINFRINGEMENT. IN NO EVENT SHALL THE AUTHORS OR COPYRIGHT HOLDERS BE LIABLE FOR ANY CLAIM, DAMAGES OR OTHER LIABILITY, WHETHER IN AN ACTION OF CONTRACT, TORT OR OTHERWISE, ARISING FROM, OUT OF OR IN CONNECTION WITH THE SOFTWARE OR THE USE OR OTHER DEALINGS IN THE SOFTWARE.

Exhibit (R)

Copyright (c) 1998 Red Hat Software

Permission is hereby granted, free of charge, to any person obtaining a copy of this software and associated documentation files (the "Software"), to deal in the Software without restriction, including without limitation the rights to use, copy, modify, merge, publish, distribute, sublicense, and/or sell copies of the Software, and to permit persons to whom the Software is furnished to do so, subject to the following conditions:

The above copyright notice and this permission notice shall be included in all copies or substantial portions of the Software.

THE SOFTWARE IS PROVIDED "AS IS", WITHOUT WARRANTY OF ANY KIND, EXPRESS OR IMPLIED, INCLUDING BUT NOT LIMITED TO THE WARRANTIES OF MERCHANTABILITY, FITNESS FOR A PARTICULAR PURPOSE AND NONINFRINGEMENT. IN NO EVENT SHALL THE X CONSORTIUM BE LIABLE FOR ANY CLAIM, DAMAGES OR OTHER LIABILITY, WHETHER IN AN ACTION OF CONTRACT, TORT OR OTHERWISE, ARISING FROM, OUT OF OR IN CONNECTION WITH THE SOFTWARE OR THE USE OR OTHER DEALINGS IN THE SOFTWARE.

Except as contained in this notice, the name of the X Consortium shall not be used in advertising or otherwise to promote the sale, use or other dealings in this Software without prior written authorization from the X Consortium.

Exhibit (S)

Copyright 2012 jQuery Foundation and other contributors, <http://jqueryui.com/>

This software consists of voluntary contributions made by many individuals (AUTHORS.txt, <http://jqueryui.com/about>) For exact contribution history, see the revision history and logs, available at <http://jquery-ui.googlecode.com/svn/>

Permission is hereby granted, free of charge, to any person obtaining a copy of this software and associated documentation files (the "Software"), to deal in the Software without restriction, including without limitation the rights to use, copy, modify, merge, publish, distribute, sublicense, and/or sell copies of the Software, and to permit persons to whom the Software is furnished to do so, subject to the following conditions:

The above copyright notice and this permission notice shall be included in all copies or substantial portions of the Software.

THE SOFTWARE IS PROVIDED "AS IS", WITHOUT WARRANTY OF ANY KIND, EXPRESS OR IMPLIED, INCLUDING BUT NOT LIMITED TO THE WARRANTIES OF MERCHANTABILITY, FITNESS FOR A PARTICULAR PURPOSE AND NONINFRINGEMENT. IN NO EVENT SHALL THE AUTHORS OR COPYRIGHT HOLDERS BE LIABLE FOR ANY CLAIM, DAMAGES OR OTHER LIABILITY, WHETHER IN AN ACTION OF CONTRACT, TORT OR OTHERWISE, ARISING FROM, OUT OF OR IN CONNECTION WITH THE SOFTWARE OR THE USE OR OTHER DEALINGS IN THE SOFTWARE.

Exhibit (T)

Copyright (c) 2010-2012 Jeremy Ashkenas, DocumentCloud

Permission is hereby granted, free of charge, to any person obtaining a copy of this software and associated documentation files (the "Software"), to deal in the Software without restriction, including without limitation the rights to use, copy, modify, merge, publish, distribute, sublicense, and/or sell copies of the Software, and to permit persons to whom the Software is furnished to do so, subject to the following conditions:

The above copyright notice and this permission notice shall be included in all copies or substantial portions of the Software.

THE SOFTWARE IS PROVIDED "AS IS", WITHOUT WARRANTY OF ANY KIND, EXPRESS OR IMPLIED, INCLUDING BUT NOT LIMITED TO THE WARRANTIES OF MERCHANTABILITY, FITNESS FOR A PARTICULAR PURPOSE AND NONINFRINGEMENT. IN NO EVENT SHALL THE AUTHORS OR COPYRIGHT HOLDERS BE LIABLE FOR ANY CLAIM, DAMAGES OR OTHER LIABILITY, WHETHER IN AN ACTION OF CONTRACT, TORT OR OTHERWISE, ARISING FROM, OUT OF OR IN CONNECTION WITH THE SOFTWARE OR THE USE OR OTHER DEALINGS IN THE SOFTWARE.

Exhibit (U)

Copyright (c) 2009-2012 Jeremy Ashkenas, DocumentCloud

Permission is hereby granted, free of charge, to any person obtaining a copy of this software and associated documentation files (the "Software"), to deal in the Software without restriction, including without limitation the rights to use, copy, modify, merge, publish, distribute, sublicense, and/or sell copies of the Software, and to permit persons to whom the Software is furnished to do so, subject to the following conditions:

The above copyright notice and this permission notice shall be included in all copies or substantial portions of the Software.

THE SOFTWARE IS PROVIDED "AS IS", WITHOUT WARRANTY OF ANY KIND, EXPRESS OR IMPLIED, INCLUDING BUT NOT LIMITED TO THE WARRANTIES OF MERCHANTABILITY, FITNESS FOR A PARTICULAR PURPOSE AND NONINFRINGEMENT. IN NO EVENT SHALL THE AUTHORS OR COPYRIGHT HOLDERS BE LIABLE FOR ANY CLAIM, DAMAGES OR OTHER LIABILITY, WHETHER IN AN ACTION OF CONTRACT, TORT OR OTHERWISE, ARISING FROM, OUT OF OR IN CONNECTION WITH THE SOFTWARE OR THE USE OR OTHER DEALINGS IN THE SOFTWARE.

Exhibit (V)

GPLV2 LICENCE AGREEMENT FOR MALI GPUS LINUX KERNEL DEVICE DRIVERS SOURCE CODE

THE USE OF THE SOFTWARE ACCOMPANYING THIS DOCUMENT IS EXPRESSLY SUBJECT TO THE TERMS OF THE GNU GENERAL PUBLIC LICENSE VERSION 2 AS PUBLISHED BY THE FREE SOFTWARE FOUNDATION AND SET OUT BELOW FOR REFERENCE (?GPL LICENCE?). ARM IS ONLY WILLING TO DISTRIBUTE THE SOFTWARE TO YOU ON CONDITION THAT YOU ACCEPT ALL OF THE TERMS IN THE GPL LICENCE PRIOR TO MODIFYING OR DISTRIBUTING THE SOFTWARE.

Further for the period of three (3) years, ARM hereby offers to make available the source code of any part of the software program that is supplied as object code or in executable form.

GPL Licence

GNU GENERAL PUBLIC LICENSE

Version 2, June 1991

Copyright (C) 1989, 1991 Free Software Foundation, Inc., 51 Franklin Street, Fifth Floor, Boston, MA 02110-1301 USA. Everyone is permitted to copy and distribute verbatim copies of this license document, but changing it is not allowed.

Preamble

The licenses for most software are designed to take away your freedom to share and change it. By contrast, the GNU General Public License is intended to guarantee your freedom to share and change free software—to make sure the software is free for all its users. This General Public License applies to most of the Free Software Foundation's software and to any other program whose authors commit to using it. (Some other Free Software Foundation software is covered by the GNU Lesser General Public License instead.) You can apply it to your programs, too.

When we speak of free software, we are referring to freedom, not price. Our General Public Licenses are designed to make sure that you have the freedom to distribute copies of free software (and charge for this service if you wish), that you receive source code or can get it if you want it, that you can change the software or use pieces of it in new free programs; and that you know you can do these things.

To protect your rights, we need to make restrictions that forbid anyone to deny you these rights or to ask you to surrender the rights. These restrictions translate to certain responsibilities for you if you distribute copies of the software, or if you modify it.

For example, if you distribute copies of such a program, whether gratis or for a fee, you must give the recipients all the rights that you have. You must make sure that they, too, receive or can get the source code. And you must show them these terms so they know their rights.

We protect your rights with two steps: (1) copyright the software, and (2) offer you this license which gives you legal permission to copy, distribute and/or modify the software.

Aso, for each author's protection and ours, we want to make certain that everyone understands that there is no warranty for this free software. If the software is modified by someone else and passed on, we want its recipients to know that what they have is not the original, so that any problems introduced by others will not reflect on the original authors' reputations.

Finally, any free program is threatened constantly by software patents. We wish to avoid the danger that redistributors of a free program will individually obtain patent licenses, in effect making the program proprietary. To prevent this, we have made it clear that any patent must be licensed for everyone's free use or not licensed at all.

The precise terms and conditions for copying, distribution and modification follow.

GNU GENERAL PUBLIC LICENSE

TERMS AND CONDITIONS FOR COPYING, DISTRIBUTION AND MODIFICATION

0. This License applies to any program or other work which contains a notice placed by the copyright holder saying it may be distributed under the terms of this General Public License. The "Program", below, refers to any such program or work, and a "work based on the Program" means either the Program or any derivative work under copyright law: that is to say, a work containing the Program or a portion of it, either verbatim or with modifications and/or translated into another language. (Hereinafter, translation is included without limitation in the term "modification".) Each licensee is addressed as "you".

本機で使われるソフトウェアライセンス情報 (つづき)

Activities other than copying, distribution and modification are not covered by this License; they are outside its scope. The act of running the Program is not restricted, and the output from the Program is covered only if its contents constitute a work based on the Program (independent of having been made by running the Program).

Whether that is true depends on what the Program does.

1. You may copy and distribute verbatim copies of the Program's source code as you receive it, in any medium, provided that you conspicuously and appropriately publish on each copy an appropriate copyright notice and disclaimer of warranty; keep intact all the notices that refer to this License and to the absence of any warranty;

and give any other recipients of the Program a copy of this License along with the Program.

You may charge a fee for the physical act of transferring a copy, and you may at your option offer warranty protection in exchange for a fee.

2. You may modify your copy or copies of the Program or any portion of it, thus forming a work based on the Program, and copy and distribute such modifications or work under the terms of Section 1 above, provided that you also meet all of these conditions:

a) You must cause the modified files to carry prominent notices stating that you changed the files and the date of any change.

b) You must cause any work that you distribute or publish, that in whole or in part contains or is derived from the Program or any part thereof, to be licensed as a whole at no charge to all third parties under the terms of this License.

c) If the modified program normally reads commands interactively when run, you must cause it, when started running for such interactive use in the most ordinary way, to print or display an announcement including an appropriate copyright notice and a notice that there is no warranty (or else, saying that you provide a warranty) and that users may redistribute the program under these conditions, and telling the user how to view a copy of this License. (Exception: if the Program itself is interactive but does not normally print such an announcement, your work based on the Program is not required to print an announcement.)

These requirements apply to the modified work as a whole. If identifiable sections of that work are not derived from the Program, and can be reasonably considered independent and separate works in themselves, then this License, and its terms, do not apply to those sections when you distribute them as separate works. But when you distribute the same sections as part of a whole which is a work based on the Program, the distribution of the whole must be on the terms of this License, whose permissions for other licensees extend to the entire whole, and thus to each and every part regardless of who wrote it.

Thus, it is not the intent of this section to claim rights or contest your rights to work written entirely by you; rather, the intent is to exercise the right to control the distribution of derivative or collective works based on the Program.

In addition, mere aggregation of another work not based on the Program with the Program (or with a work based on the Program) on a volume of a storage or distribution medium does not bring the other work under the scope of this License.

3. You may copy and distribute the Program (or a work based on it, under Section 2) in object code or executable form under the terms of Sections 1 and 2 above provided that you also do one of the following:

a) Accompany it with the complete corresponding machine-readable source code, which must be distributed under the terms of Sections 1 and 2 above on a medium customarily used for software interchange; or,

b) Accompany it with a written offer, valid for at least three years, to give any third party, for a charge no more than your cost of physically performing source distribution, a complete machine-readable copy of the corresponding source code, to be distributed under the terms of Sections 1 and 2 above on a medium customarily used for software interchange; or,

c) Accompany it with the information you received as to the offer to distribute corresponding source code. (This alternative is allowed only for noncommercial distribution and only if you received the program in object code or executable form with such an offer, in accord with Subsection b above.)

The source code for a work means the preferred form of the work for making modifications to it. For an executable work, complete source code means all the source code for all modules it contains, plus any associated interface definition files, plus the scripts used to control compilation and installation of the executable. However, as a special exception, the source code distributed need not include anything that is normally distributed (in either source or binary form) with the major components (compiler, kernel, and so on) of the operating system on which the executable runs, unless that component itself accompanies the executable.

If distribution of executable or object code is made by offering access to copy from a designated place, then offering equivalent access to copy the source code from the same place counts as distribution of the source code, even though third parties are not compelled to copy the source along with the object code.

4. You may not copy, modify, sublicense, or distribute the Program except as expressly provided under this License. Any attempt otherwise to copy, modify, sublicense or distribute the Program is void, and will automatically terminate your rights under this License. However, parties who have received copies, or rights, from you under this License will not have their licenses terminated so long as such parties remain in full compliance.

5. You are not required to accept this License, since you have not signed it. However, nothing else grants you permission to modify or distribute the Program or its derivative works. These actions are prohibited by law if you do not accept this License. Therefore, by modifying or distributing the Program (or any work based on the

Program), you indicate your acceptance of this License to do so, and all its terms and conditions for copying, distributing or modifying the Program or works based on it.

6. Each time you redistribute the Program (or any work based on the Program), the recipient automatically receives a license from the original licensor to copy, distribute or modify the Program subject to these terms and conditions. You may not impose any further restrictions on the recipients' exercise of the rights granted herein.

You are not responsible for enforcing compliance by third parties to this License.

7. If, as a consequence of a court judgment or allegation of patent infringement or for any other reason (not limited to patent issues), conditions are imposed on you (whether by court order, agreement or otherwise) that contradict the conditions of this License, they do not excuse you from the conditions of this License. If you cannot distribute so as to satisfy simultaneously your obligations under this License and any other pertinent obligations, then as a consequence you may not distribute the Program at all. For example, if a patent license would not permit royalty-free redistribution of the Program by all those who receive copies directly or indirectly through you, then the only way you could satisfy both it and this License would be to refrain entirely from distribution of the Program.

If any portion of this section is held invalid or unenforceable under any particular circumstance, the balance of the section is intended to apply and the section as a whole is intended to apply in other circumstances.

It is not the purpose of this section to induce you to infringe any patents or other property right claims or to contest validity of any such claims; this section has the sole purpose of protecting the integrity of the free software distribution system, which is implemented by public license practices. Many people have made generous contributions to the wide range of software distributed through that system in reliance on consistent application of that system; it is up to the author/donor to decide if he/she is willing to distribute software through any other system and a licensee cannot impose that choice.

This section is intended to make thoroughly clear what is believed to be a consequence of the rest of this License.

8. If the distribution and/or use of the Program is restricted in certain countries either by patents or by copyrighted interfaces, the original copyright holder who places the Program under this License may add an explicit geographical distribution limitation excluding those countries, so that distribution is permitted only in or among countries not thus excluded. In such case, this License incorporates the limitation as if written in the body of this License.

9. The Free Software Foundation may publish revised and/or new versions of the General Public License from time to time. Such new versions will be similar in spirit to the present version, but may differ in detail to address new problems or concerns.

Each version is given a distinguishing version number. If the Program specifies a version number of this License which applies to it and "any later version", you have the option of following the terms and conditions either of that version or of any later version published by the Free Software Foundation. If the Program does not specify a version number of this License, you may choose any version ever published by the Free Software Foundation.

10. If you wish to incorporate parts of the Program into other free programs whose distribution conditions are different, write to the author to ask for permission. For software which is copyrighted by the Free Software Foundation, write to the Free Software Foundation; we sometimes make exceptions for this. Our decision will be guided by the two goals of preserving the free status of all derivatives of our free software and of promoting the sharing and reuse of software generally.

NO WARRANTY

11. BECAUSE THE PROGRAM IS LICENSED FREE OF CHARGE, THERE IS NO WARRANTY FOR THE PROGRAM, TO THE EXTENT PERMITTED BY APPLICABLE LAW, EXCEPT WHEN OTHERWISE STATED IN WRITING THE COPYRIGHT HOLDERS AND/OR OTHER PARTIES PROVIDE THE PROGRAM "AS IS" WITHOUT WARRANTY OF ANY KIND, EITHER EXPRESSED OR IMPLIED, INCLUDING, BUT NOT LIMITED TO, THE IMPLIED WARRANTIES OF MERCHANTABILITY AND FITNESS FOR A PARTICULAR PURPOSE. THE ENTIRE RISK AS TO THE QUALITY AND PERFORMANCE OF THE PROGRAM IS WITH YOU. SHOULD THE PROGRAM PROVE DEFECTIVE, YOU ASSUME THE COST OF ALL NECESSARY SERVICING, REPAIR OR CORRECTION.

12. IN NO EVENT UNLESS REQUIRED BY APPLICABLE LAW OR AGREED TO IN WRITING WILL ANY COPYRIGHT HOLDER, OR ANY OTHER PARTY WHO MAY MODIFY AND/OR REDISTRIBUTE THE PROGRAM AS PERMITTED ABOVE, BE LIABLE TO YOU FOR DAMAGES, INCLUDING ANY GENERAL, SPECIAL, INCIDENTAL OR CONSEQUENTIAL DAMAGES ARISING OUT OF THE USE OR INABILITY TO USE THE PROGRAM (INCLUDING BUT NOT LIMITED TO LOSS OF DATA OR DATA BEING RENDERED INACCURATE OR LOSSES SUSTAINED BY YOU OR THIRD PARTIES OR A FAILURE OF THE PROGRAM TO OPERATE WITH ANY OTHER PROGRAMS), EVEN IF SUCH HOLDER OR OTHER PARTY HAS BEEN ADVISED OF THE POSSIBILITY OF SUCH DAMAGES.

Exhibit (W)

Copyright (C) 1998-2012 Daniel Veillard. All Rights Reserved.

Permission is hereby granted, free of charge, to any person obtaining a copy of this software and associated documentation files (the "Software"), to deal in the Software without restriction, including without limitation the rights to use, copy, modify, merge, publish, distribute, sublicense, and/or sell copies of the Software, and to permit persons to whom the Software is furnished to do so, subject to the following conditions:

The above copyright notice and this permission notice shall be included in all copies or substantial portions of the Software.

THE SOFTWARE IS PROVIDED "AS IS", WITHOUT WARRANTY OF ANY KIND, EXPRESS OR IMPLIED, INCLUDING BUT NOT LIMITED TO THE WARRANTIES OF MERCHANTABILITY, FITNESS FOR A PARTICULAR PURPOSE AND NONINFRINGEMENT. IN NO EVENT SHALL THE AUTHORS OR COPYRIGHT HOLDERS BE LIABLE FOR ANY CLAIM, DAMAGES OR OTHER LIABILITY, WHETHER IN AN ACTION OF CONTRACT, TORT OR OTHERWISE, ARISING FROM, OUT OF OR IN CONNECTION WITH THE SOFTWARE OR THE USE OR OTHER DEALINGS IN THE SOFTWARE.

* Copyright (C) 2000,2012 Bjorn Reese and Daniel Veillard.

* Permission to use, copy, modify, and distribute this software for any purpose with or without fee is hereby granted, provided that the above copyright notice and this permission notice appear in all copies.

* THIS SOFTWARE IS PROVIDED "AS IS" AND WITHOUT ANY EXPRESS OR IMPLIED WARRANTIES, INCLUDING, WITHOUT LIMITATION, THE IMPLIED WARRANTIES OF MERCHANTABILITY AND FITNESS FOR A PARTICULAR PURPOSE. THE AUTHORS AND CONTRIBUTORS ACCEPT NO RESPONSIBILITY IN ANY CONCEIVABLE MANNER.

* Copyright (C) 2003-2012 Daniel Veillard.

* Permission to use, copy, modify, and distribute this software for any purpose with or without fee is hereby granted, provided that the above copyright notice and this permission notice appear in all copies.

* THIS SOFTWARE IS PROVIDED "AS IS" AND WITHOUT ANY EXPRESS OR IMPLIED WARRANTIES, INCLUDING, WITHOUT LIMITATION, THE IMPLIED WARRANTIES OF MERCHANTABILITY AND FITNESS FOR A PARTICULAR PURPOSE. THE AUTHORS AND CONTRIBUTORS ACCEPT NO RESPONSIBILITY IN ANY CONCEIVABLE MANNER.

* Copyright (C) 2000 Gary Pennington and Daniel Veillard.

* Permission to use, copy, modify, and distribute this software for any purpose with or without fee is hereby granted, provided that the above copyright notice and this permission notice appear in all copies.

* THIS SOFTWARE IS PROVIDED "AS IS" AND WITHOUT ANY EXPRESS OR IMPLIED WARRANTIES, INCLUDING, WITHOUT LIMITATION, THE IMPLIED WARRANTIES OF MERCHANTABILITY AND FITNESS FOR A PARTICULAR PURPOSE. THE AUTHORS AND CONTRIBUTORS ACCEPT NO RESPONSIBILITY IN ANY CONCEIVABLE MANNER.

* Copyright (C) 1998 Bjorn Reese and Daniel Stenberg.

* Permission to use, copy, modify, and distribute this software for any purpose with or without fee is hereby granted, provided that the above copyright notice and this permission notice appear in all copies.

* THIS SOFTWARE IS PROVIDED "AS IS" AND WITHOUT ANY EXPRESS OR IMPLIED WARRANTIES, INCLUDING, WITHOUT LIMITATION, THE IMPLIED WARRANTIES OF MERCHANTABILITY AND FITNESS FOR A PARTICULAR PURPOSE. THE AUTHORS AND CONTRIBUTORS ACCEPT NO RESPONSIBILITY IN ANY CONCEIVABLE MANNER.

* Copyright (C) 2001 Bjorn Reese <breesee@users.sourceforge.net>

* Permission to use, copy, modify, and distribute this software for any purpose with or without fee is hereby granted, provided that the above copyright notice and this permission notice appear in all copies.

* THIS SOFTWARE IS PROVIDED "AS IS" AND WITHOUT ANY EXPRESS OR IMPLIED WARRANTIES, INCLUDING, WITHOUT LIMITATION, THE IMPLIED WARRANTIES OF MERCHANTABILITY AND FITNESS FOR A PARTICULAR PURPOSE. THE AUTHORS AND CONTRIBUTORS ACCEPT NO RESPONSIBILITY IN ANY CONCEIVABLE MANNER.

* Copyright (C) 2000 Bjorn Reese and Daniel Stenberg.

* Permission to use, copy, modify, and distribute this software for any purpose with or without fee is hereby granted, provided that the above copyright notice and this permission notice appear in all copies.

* THIS SOFTWARE IS PROVIDED "AS IS" AND WITHOUT ANY EXPRESS OR IMPLIED WARRANTIES, INCLUDING, WITHOUT LIMITATION, THE IMPLIED WARRANTIES OF MERCHANTABILITY AND FITNESS FOR A PARTICULAR PURPOSE. THE AUTHORS AND CONTRIBUTORS ACCEPT NO RESPONSIBILITY IN ANY CONCEIVABLE MANNER.

* Copyright (C) 2001 Bjorn Reese and Daniel Stenberg.

* Permission to use, copy, modify, and distribute this software for any purpose with or without fee is hereby granted, provided that the above copyright notice and this permission notice appear in all copies.

* THIS SOFTWARE IS PROVIDED "AS IS" AND WITHOUT ANY EXPRESS OR IMPLIED WARRANTIES, INCLUDING, WITHOUT LIMITATION, THE IMPLIED WARRANTIES OF MERCHANTABILITY AND FITNESS FOR A PARTICULAR PURPOSE. THE AUTHORS AND CONTRIBUTORS ACCEPT NO RESPONSIBILITY IN ANY CONCEIVABLE MANNER.

* All code in this header, unless otherwise specified, is hereby licensed under the MIT Public License:

Copyright (c) 2010 Christopher Swenson

Permission is hereby granted, free of charge, to any person obtaining a copy of this software and associated documentation files (the "Software"), to deal in the Software without restriction, including without limitation the rights to use, copy, modify, merge, publish, distribute, sublicense, and/or sell copies of the Software, and to permit persons to whom the Software is furnished to do so, subject to the following conditions:

The above copyright notice and this permission notice shall be included in all copies or substantial portions of the Software.

THE SOFTWARE IS PROVIDED "AS IS", WITHOUT WARRANTY OF ANY KIND, EXPRESS OR IMPLIED, INCLUDING BUT NOT LIMITED TO THE WARRANTIES OF MERCHANTABILITY, FITNESS FOR A PARTICULAR PURPOSE AND NONINFRINGEMENT. IN NO EVENT SHALL THE AUTHORS OR COPYRIGHT HOLDERS BE LIABLE FOR ANY CLAIM, DAMAGES OR OTHER LIABILITY, WHETHER IN AN ACTION OF CONTRACT, TORT OR OTHERWISE, ARISING FROM, OUT OF OR IN CONNECTION WITH THE SOFTWARE OR THE USE OR OTHER DEALINGS IN THE SOFTWARE.

Exhibit (X)

This copy of the libpng notices is provided for your convenience. In case of any discrepancy between this copy and the notices in the file png.h that is included in the libpng distribution, the latter shall prevail.

COPYRIGHT NOTICE, DISCLAIMER, and LICENSE:

If you modify libpng you may insert additional notices immediately following this sentence.

libpng versions 1.2.6, August 15, 2004, through 1.2.32, September 18, 2008, are Copyright (c) 2004, 2006-2008 Glenn Randers-Pehrson, and are distributed according to the same disclaimer and license as libpng-1.2.5 with the following individual added to the list of Contributing Authors

Cosmin Truta

libpng versions 1.0.7, July 1, 2000, through 1.2.5 - October 3, 2002, are Copyright (c) 2000-2002 Glenn Randers-Pehrson, and are distributed according to the same disclaimer and license as libpng-1.0.6 with the following individuals added to the list of Contributing Authors

Simon-Pierre Cadieux
Eric S. Raymond
Gilles Vollant

and with the following additions to the disclaimer:

There is no warranty against interference with your enjoyment of the library or against infringement. There is no warranty that our efforts or the library will fulfill any of your particular purposes or needs. This library is provided with all faults, and the entire risk of satisfactory quality, performance, accuracy, and effort is with the user.

libpng versions 0.97, January 1998, through 1.0.6, March 20, 2000, are Copyright (c) 1998, 1999 Glenn Randers-Pehrson, and are distributed according to the same disclaimer and license as libpng-0.96, with the following individuals added to the list of Contributing Authors:

Tom Lane
Glenn Randers-Pehrson
Willem van Schaik

libpng versions 0.89, June 1996, through 0.96, May 1997, are Copyright (c) 1996, 1997 Andreas Dilger
Distributed according to the same disclaimer and license as libpng-0.88, with the following individuals added to the list of Contributing Authors:

John Bowler
Kevin Bracey
Sam Bushell
Magnus Holmgren
Greg Roelofs
Tom Tanner

libpng versions 0.5, May 1995, through 0.88, January 1996, are Copyright (c) 1995, 1996 Guy Eric Schalnat, Group 42, Inc.

For the purposes of this copyright and license, "Contributing Authors" is defined as the following set of individuals:

Andreas Dilger
Dave Martindale
Guy Eric Schalnat
Paul Schmidt
Tim Wegner

The PNG Reference Library is supplied "AS IS". The Contributing Authors and Group 42, Inc. disclaim all warranties, expressed or implied, including, without limitation, the warranties of merchantability and of fitness for any purpose. The Contributing Authors and Group 42, Inc. assume no liability for direct, indirect, incidental, special, exemplary, or consequential damages, which may result from the use of the PNG Reference Library, even if advised of the possibility of such damage.

Permission is hereby granted to use, copy, modify, and distribute this source code, or portions hereof, for any purpose, without fee, subject to the following restrictions:

1. The origin of this source code must not be misrepresented.
2. Altered versions must be plainly marked as such and must not be misrepresented as being the original source.
3. This Copyright notice may not be removed or altered from any source or altered source distribution.

The Contributing Authors and Group 42, Inc. specifically permit, without fee, and encourage the use of this source code as a component to supporting the PNG file format in commercial products. If you use this source code in a product, acknowledgment is not required but would be appreciated.

A "png_get_copyright" function is available, for convenient use in "about" boxes and the like:

```
printf("%s",png_get_copyright(NULL));
```

Also, the PNG logo (in PNG format, of course) is supplied in the files "pngbar.png" and "pngbar.jpg (88x31) and "pngnow.png" (98x31).

Libpng is OSI Certified Open Source Software. OSI Certified Open Source is a certification mark of the Open Source Initiative.

Glenn Randers-Pehrson
glennrp at users.sourceforge.net
September 18, 2008

本機で使われるソフトウェアライセンス情報 (つづき)

Exhibit (Y)

ZLIB DATA COMPRESSION LIBRARY

zlib 1.2.11 is a general purpose data compression library. All the code is thread safe. The data format used by the zlib library is described by RFCs (Request for Comments) 1950 to 1952 in the files <http://tools.ietf.org/html/rfc1950> (zlib format), [rfc1951](http://tools.ietf.org/html/rfc1951) (deflate format) and [rfc1952](http://tools.ietf.org/html/rfc1952) (gzip format).

All functions of the compression library are documented in the file `zlib.h` (volunteer to write man pages welcome, contact zlib@gzip.org). A usage example of the library is given in the file `test/example.c` which also tests that the library is working correctly. Another example is given in the file `test/minizip.c`. The compression library itself is composed of all source files in the root directory.

To compile all files and run the test program, follow the instructions given at the top of `Makefile.in`. In short, `./configure; make test`, and if that goes well, "make install" should work for most flavors of Unix. For Windows, use one of the special makefiles in `win32/` or `contrib/vstudio/`. For VMS, use `make_vms.com`.

Questions about zlib should be sent to zlib@gzip.org, or to Gilles Vollant info@winimage.com for the Windows DLL version. The zlib home page is <http://zlib.net/>. Before reporting a problem, please check this site to verify that you have the latest version of zlib; otherwise get the latest version and check whether the problem still exists or not.

PLEASE read the zlib FAQ http://zlib.net/zlib_faq.html before asking for help.

Mark Nelson markn@eee.org wrote an article about zlib for the Jan. 1997 issue of Dr. Dobbs's Journal; a copy of the article is available at <http://marknelson.us/1997/01/01/zlib-engine/>.

The changes made in version 1.2.11 are documented in the file `ChangeLog`.

Unsupported third party contributions are provided in directory `contrib/`.

zlib is available in Java using the `java.util.zip` package, documented at <http://java.sun.com/developer/technicalArticles/Programming/compression/>.

A Perl interface to zlib written by Paul Marquess pmqs@cpan.org is available at CPAN (Comprehensive Perl Archive Network) sites, including <http://search.cpan.org/~pmqs/IO-Compress-Zlib/>.

A Python interface to zlib written by A.M. Kuchling amk@amk.ca is available in Python 1.5 and later versions, see <http://docs.python.org/library/zlib.html>.

zlib is built into tcl: <http://wiki.tcl.tk/4610>.

An experimental package to read and write files in .zip format, written on top of zlib by Gilles Vollant info@winimage.com, is available in the `contrib/minizip` directory of zlib.

Notes for some targets:

- For Windows DLL versions, please see `win32/DLL_FAQ.txt`
- For 64-bit Irix, `deflate.c` must be compiled without any optimization. With `-O`, one `libpng` test fails. The test works in 32 bit mode (with the `-n32` compiler flag). The compiler bug has been reported to SGI.
- zlib doesn't work with gcc 2.6.3 on a DEC 3000/300LX under OSF/1 2.1 it works when compiled with cc.
- On Digital Unix 4.0D (formerly OSF/1) on AlphaServer, the cc option `-std1` is necessary to get `gzprintf` working correctly. This is done by configure.
- zlib doesn't work on HP-UX 9.05 with some versions of `/bin/cc`. It works with other compilers. Use "make test" to check your compiler.
- `gzdopen` is not supported on RISCOS or BEOS.
- For PalmOS, see <http://palmzlib.sourceforge.net/>

Acknowledgments:

The deflate format used by zlib was defined by Phil Katz. The deflate and zlib specifications were written by L. Peter Deutsch. Thanks to all the people who reported problems and suggested various improvements in zlib; they are too numerous to cite here.

Copyright notice:

(C) 1995-2017 Jean-loup Gailly and Mark Adler

This software is provided 'as-is', without any express or implied warranty. In no event will the authors be held liable for any damages arising from the use of this software.

Permission is granted to anyone to use this software for any purpose, including commercial applications, and to alter it and redistribute it freely, subject to the following restrictions:

1. The origin of this software must not be misrepresented; you must not claim that you wrote the original software. If you use this software in a product, an acknowledgment in the product documentation would be appreciated but is not required.
2. Altered source versions must be plainly marked as such, and must not be misrepresented as being the original software.
3. This notice may not be removed or altered from any source distribution.

Jean-loup Gailly Mark Adler
jloup@gzip.org madler@alumni.caltech.edu

If you use the zlib library in a product, we would appreciate *not* receiving lengthy legal documents to sign. The sources are provided for free but without warranty of any kind. The library has been entirely written by Jean-loup Gailly and Mark Adler; it does not include third-party code.

If you redistribute modified sources, we would appreciate that you include in the file `ChangeLog` history information documenting your changes. Please read the FAQ for more information on the distribution of modified source versions.

Exhibit (Z)

Libevent is available for use under the following license, commonly known as the 3-clause (or "modified") BSD license:

=====
Copyright (c) 2000-2007 Niels Provos <provos@citi.umich.edu>
Copyright (c) 2007-2012 Niels Provos and Nick Mathewson

Redistribution and use in source and binary forms, with or without modification, are permitted provided that the following conditions are met:

1. Redistributions of source code must retain the above copyright notice, this list of conditions and the following disclaimer.
2. Redistributions in binary form must reproduce the above copyright notice, this list of conditions and the following disclaimer in the documentation and/or other materials provided with the distribution.
3. The name of the author may not be used to endorse or promote products derived from this software without specific prior written permission.

THIS SOFTWARE IS PROVIDED BY THE AUTHOR "AS IS" AND ANY EXPRESS OR IMPLIED WARRANTIES, INCLUDING, BUT NOT LIMITED TO, THE IMPLIED WARRANTIES OF MERCHANTABILITY AND FITNESS FOR A PARTICULAR PURPOSE ARE DISCLAIMED. IN NO EVENT SHALL THE AUTHOR BE LIABLE FOR ANY DIRECT, INDIRECT, INCIDENTAL, SPECIAL, EXEMPLARY, OR CONSEQUENTIAL DAMAGES (INCLUDING, BUT NOT LIMITED TO, PROCUREMENT OF SUBSTITUTE GOODS OR SERVICES; LOSS OF USE, DATA, OR PROFITS; OR BUSINESS INTERRUPTION) HOWEVER CAUSED AND ON ANY THEORY OF LIABILITY, WHETHER IN CONTRACT, STRICT LIABILITY, OR TORT (INCLUDING NEGLIGENCE OR OTHERWISE) ARISING IN ANY WAY OUT OF THE USE OF THIS SOFTWARE, EVEN IF ADVISED OF THE POSSIBILITY OF SUCH DAMAGE.

Portions of Libevent are based on works by others, also made available by them under the three-clause BSD license above. The copyright notices are available in the corresponding source files; the license is as above. Here's a list:

log.c:
Copyright (c) 2000 Dug Song <dugsong@monkey.org>
Copyright (c) 1993 The Regents of the University of California.

strlcpy.c:
Copyright (c) 1998 Todd C. Miller <Todd.Miller@courtesan.com>

win32select.c:
Copyright (c) 2003 Michael A. Davis <mike@datanerds.net>

evport.c:
Copyright (c) 2007 Sun Microsystems

ht-internal.h:
Copyright (c) 2002 Christopher Clark

minheap-internal.h:
Copyright (c) 2006 Maxim Yegorushkin <maxim.yegorushkin@gmail.com>

=====
The `arc4module` is available under the following, sometimes called the "OpenBSD" license:

Copyright (c) 1996, David Mazieres <dm@uun.org>
Copyright (c) 2008, Damien Miller <djm@openbsd.org>

Permission to use, copy, modify, and distribute this software for any purpose with or without fee is hereby granted, provided that the above copyright notice and this permission notice appear in all copies.

THE SOFTWARE IS PROVIDED "AS IS" AND THE AUTHOR DISCLAIMS ALL WARRANTIES WITH REGARD TO THIS SOFTWARE INCLUDING ALL IMPLIED WARRANTIES OF MERCHANTABILITY AND FITNESS. IN NO EVENT SHALL THE AUTHOR BE LIABLE FOR ANY SPECIAL, DIRECT, INDIRECT, OR CONSEQUENTIAL DAMAGES OR ANY DAMAGES WHATSOEVER RESULTING FROM LOSS OF USE, DATA OR PROFITS, WHETHER IN AN ACTION OF CONTRACT, NEGLIGENCE OR OTHER TORTIOUS ACTION, ARISING OUT OF OR IN CONNECTION WITH THE USE OR PERFORMANCE OF THIS SOFTWARE.

Exhibit (a)

libffi - Copyright (c) 1996-2014 Anthony Green, Red Hat, Inc and others.
See source files for details.

Permission is hereby granted, free of charge, to any person obtaining a copy of this software and associated documentation files (the "Software"), to deal in the Software without restriction, including without limitation the rights to use, copy, modify, merge, publish, distribute, sublicense, and/or sell copies of the Software, and to permit persons to whom the Software is furnished to do so, subject to the following conditions:

The above copyright notice and this permission notice shall be included in all copies or substantial portions of the Software.

THE SOFTWARE IS PROVIDED "AS IS", WITHOUT WARRANTY OF ANY KIND, EXPRESS OR IMPLIED, INCLUDING BUT NOT LIMITED TO THE WARRANTIES OF MERCHANTABILITY, FITNESS FOR A PARTICULAR PURPOSE AND NONINFRINGEMENT. IN NO EVENT SHALL THE AUTHORS OR COPYRIGHT HOLDERS BE LIABLE FOR ANY CLAIM, DAMAGES OR OTHER LIABILITY, WHETHER IN AN ACTION OF CONTRACT, TORT OR OTHERWISE, ARISING FROM, OUT OF OR IN CONNECTION WITH THE SOFTWARE OR THE USE OR OTHER DEALINGS IN THE SOFTWARE.

Exhibit (b)

The MIT License (MIT)

Copyright (c) 2014 Leo Horie

Permission is hereby granted, free of charge, to any person obtaining a copy of this software and associated documentation files (the "Software"), to deal in the Software without restriction, including without limitation the rights to use, copy, modify, merge, publish, distribute, sublicense, and/or sell copies of the Software, and to permit persons to whom the Software is furnished to do so, subject to the following conditions:

The above copyright notice and this permission notice shall be included in all copies or substantial portions of the Software.

THE SOFTWARE IS PROVIDED "AS IS", WITHOUT WARRANTY OF ANY KIND, EXPRESS OR IMPLIED, INCLUDING BUT NOT LIMITED TO THE WARRANTIES OF MERCHANTABILITY, FITNESS FOR A PARTICULAR PURPOSE AND NONINFRINGEMENT. IN NO EVENT SHALL THE AUTHORS OR COPYRIGHT HOLDERS BE LIABLE FOR ANY CLAIM, DAMAGES OR OTHER LIABILITY, WHETHER IN AN ACTION OF CONTRACT, TORT OR OTHERWISE, ARISING FROM, OUT OF OR IN CONNECTION WITH THE SOFTWARE OR THE USE OR OTHER DEALINGS IN THE SOFTWARE.

Exhibit (c)

(The MIT License)

Copyright (c) 2012 - 2015 Tobias Koppers

Permission is hereby granted, free of charge, to any person obtaining a copy of this software and associated documentation files (the "Software"), to deal in the Software without restriction, including without limitation the rights to use, copy, modify, merge, publish, distribute, sublicense, and/or sell copies of the Software, and to permit persons to whom the Software is furnished to do so, subject to the following conditions:

The above copyright notice and this permission notice shall be included in all copies or substantial portions of the Software.

THE SOFTWARE IS PROVIDED 'AS IS', WITHOUT WARRANTY OF ANY KIND, EXPRESS OR IMPLIED, INCLUDING BUT NOT LIMITED TO THE WARRANTIES OF MERCHANTABILITY, FITNESS FOR A PARTICULAR PURPOSE AND NONINFRINGEMENT. IN NO EVENT SHALL THE AUTHORS OR COPYRIGHT HOLDERS BE LIABLE FOR ANY CLAIM, DAMAGES OR OTHER LIABILITY, WHETHER IN AN ACTION OF CONTRACT, TORT OR OTHERWISE, ARISING FROM, OUT OF OR IN CONNECTION WITH THE SOFTWARE OR THE USE OR OTHER DEALINGS IN THE SOFTWARE.

Exhibit (d)

The FreeRTOS source code is licensed by a *modified* GNU General Public License (GPL). The modification is provided in the form of an exception.

NOTE: The modification to the GPL is included to allow you to distribute a combined work that includes FreeRTOS without being obliged to provide the source code for proprietary components outside of the FreeRTOS kernel.

The FreeRTOS GPL Exception Text:

Any FreeRTOS source code, whether modified or in its original release form, or whether in whole or in part, can only be distributed by you under the terms of the GNU General Public License plus this exception. An independent module is a module which is not derived from or based on FreeRTOS.

Clause 1:

Linking FreeRTOS statically or dynamically with other modules is making a combined work based on FreeRTOS. Thus, the terms and conditions of the GNU General Public License cover the whole combination.

As a special exception, the copyright holder of FreeRTOS gives you permission to link FreeRTOS with independent modules that communicate with FreeRTOS solely through the FreeRTOS API interface, regardless of the license terms of these independent modules, and to copy and distribute the resulting combined work under terms of your choice, provided that

+ Every copy of the combined work is accompanied by a written statement that details to the recipient the version of FreeRTOS used and an offer by yourself to provide the FreeRTOS source code (including any modifications you may have made) should the recipient request it.

+ The combined work is not itself an RTOS, scheduler, kernel or related product.

+ The independent modules add significant and primary functionality to FreeRTOS and do not merely extend the existing functionality already present in FreeRTOS.

Clause 2:

FreeRTOS may not be used for any competitive or comparative purpose, including the publication of any form of run time or compile time metric, without the express permission of Real Time Engineers Ltd. (this is the norm within the industry and is intended to ensure information accuracy).

The standard GPL exception text:

GNU GENERAL PUBLIC LICENSE Version 2, June 1991

Copyright (C) 1989, 1991 Free Software Foundation, Inc.
59 Temple Place, Suite 330, Boston, MA 02111-1307 USA
Everyone is permitted to copy and distribute verbatim copies of this license document, but changing it is not allowed.

Preamble

The licenses for most software are designed to take away your freedom to share and change it. By contrast, the GNU General Public License is intended to guarantee your freedom to share and change free software—to make sure the software is free for all its users. This General Public License applies to most of the Free Software Foundation's software and to any other program whose authors commit to using it. (Some other Free Software Foundation software is covered by the GNU Library General Public License instead.) You can apply it to your programs, too.

When we speak of free software, we are referring to freedom, not price. Our General Public Licenses are designed to make sure that you have the freedom to distribute copies of free software (and charge for this service if you wish), that you receive source code or can get it if you want it, that you can change the software or use pieces of it in new free programs; and that you know you can do these things.

To protect your rights, we need to make restrictions that forbid anyone to deny you these rights or to ask you to surrender the rights. These restrictions translate to certain responsibilities for you if you distribute copies of the software, or if you modify it.

For example, if you distribute copies of such a program, whether gratis or for a fee, you must give the recipients all the rights that you have. You must make sure that they, too, receive or can get the source code. And you must show them these terms so they know their rights.

We protect your rights with two steps: (1) copyright the software, and (2) offer you this license which gives you legal permission to copy, distribute and/or modify the software.

Also, for each author's protection and ours, we want to make certain that everyone understands that there is no warranty for this free software. If the software is modified by someone else and passed on, we want its recipients to know that what they have is not the original, so that any problems introduced by others will not reflect on the original authors' reputations.

Finally, any free program is threatened constantly by software patents. We wish to avoid the danger that redistributors of a free program will individually obtain patent licenses, in effect making the program proprietary. To prevent this, we have made it clear that any patent must be licensed for everyone's free use or not licensed at all.

The precise terms and conditions for copying, distribution and modification follow.

GNU GENERAL PUBLIC LICENSE TERMS AND CONDITIONS FOR COPYING, DISTRIBUTION AND MODIFICATION

0. This License applies to any program or other work which contains a notice placed by the copyright holder saying it may be distributed under the terms of this General Public License. The "Program", below, refers to any such program or work, and a "work based on the Program" means either the Program or any derivative work under copyright law: that is to say, a work containing the Program or a portion of it, either verbatim or with modifications and/or translated into another language. (Hereinafter, translation is included without limitation in the term "modification".) Each licensee is addressed as "you".

Activities other than copying, distribution and modification are not covered by this License; they are activities its scope. The act of running the Program is not restricted, and the output from the Program is covered only if its contents constitute a work based on the Program (independent of having been made by running the Program). Whether that is true depends on what the Program does.

1. You may copy and distribute verbatim copies of the Program's source code as you receive it, in any medium, provided that you conspicuously and appropriately publish on each copy an appropriate copyright notice and disclaimer of warranty; keep intact all the notices that refer to this License and to the absence of any warranty; and give any other recipients of the Program a copy of this License along with the Program.

You may charge a fee for the physical act of transferring a copy, and you may at your option offer warranty protection in exchange for a fee.

2. You may modify your copy or copies of the Program or any portion of it, thus forming a work based on the Program, and copy and distribute such modifications or work under the terms of Section 1 above, provided that you also meet all of these conditions:

a) You must cause the modified files to carry prominent notices stating that you changed the files and the date of any change.

b) You must cause any work that you distribute or publish, that in whole or in part contains or is derived from the Program or any part thereof, to be licensed as a whole at no charge to all third parties under the terms of this License.

c) If the modified program normally reads commands interactively when run, you must cause it, when started running for such interactive use in the most ordinary way, to print or display an announcement including an appropriate copyright notice and a notice that there is no warranty (or else, saying that you provide a warranty) and that users may redistribute the program under these conditions, and telling the user how to view a copy of this License. (Exception: if the Program itself is interactive but does not normally print such an announcement, your work based on the Program is not required to print an announcement.)

These requirements apply to the modified work as a whole. If identifiable sections of that work are not derived from the Program, and can be reasonably considered independent and separate works in themselves, then this License, and its terms, do not apply to those sections when you distribute them as separate works. But when you distribute the same sections as part of a whole which is a work based on the Program, the distribution of the whole must be on the terms of this License, whose permissions for other licensees extend to the entire whole, and thus to each and every part regardless of who wrote it.

Thus, it is not the intent of this section to claim rights or contest your rights to work written entirely by you; rather, the intent is to exercise the right to control the distribution of derivative or collective works based on the Program.

In addition, mere aggregation of another work not based on the Program with the Program (or with a work based on the Program) on a volume of a storage or distribution medium does not bring the other work under the scope of this License.

3. You may copy and distribute the Program (or a work based on it, under Section 2) in object code or executable form under the terms of Sections 1 and 2 above provided that you also do one of the following:

a) Accompany it with the complete corresponding machine-readable source code, which must be distributed under the terms of Sections 1 and 2 above on a medium customarily used for software interchange; or,

b) Accompany it with a written offer, valid for at least three years, to give any third party, for a charge no more than your cost of physically performing source distribution, a complete machine-readable copy of the corresponding source code, to be distributed under the terms of Sections 1 and 2 above on a medium customarily used for software interchange; or,

c) Accompany it with the information you received as to the offer to distribute corresponding source code. (This alternative is allowed only for noncommercial distribution and only if you received the program in object code or executable form with such an offer, in accord with Subsection b above.)

The source code for a work means the preferred form of the work for making modifications to it. For an executable work, complete source code means all the source code for all modules it contains, plus any associated interface definition files, plus the scripts used to control compilation and installation of the executable. However, as a special exception, the source code distributed need not include anything that is normally distributed (in either source or binary form) with the major components (compiler, kernel, and so on) of the operating system on which the executable runs, unless that component itself accompanies the executable.

If distribution of executable or object code is made by offering access to copy from a designated place, then offering equivalent access to copy the source code from the same place counts as distribution of the source code, even though third parties are not compelled to copy the source along with the object code.

4. You may not copy, modify, sublicense, or distribute the Program except as expressly provided under this License. Any attempt otherwise to copy, modify, sublicense or distribute the Program is void, and will automatically terminate your rights under this License. However, parties who have received copies, or rights, from you under this License will not have their licenses terminated so long as such parties remain in full compliance.

5. You are not required to accept this License, since you have not signed it. However, nothing else grants you permission to modify or distribute the Program or its derivative works. These actions are prohibited by law if you do not accept this License. Therefore, by modifying or distributing the Program (or any work based on the Program), you indicate your acceptance of this License to do so, and all its terms and conditions for copying, distributing or modifying the Program or works based on it.

6. Each time you redistribute the Program (or any work based on the Program), the recipient automatically receives a license from the original copyright holder to copy, distribute or modify the Program subject to these terms and conditions. You may not impose any further restrictions on the recipients' exercise of the rights granted herein. You are not responsible for enforcing compliance by third parties to this License.

7. If, as a consequence of a court judgment or allegation of patent infringement or for any other reason (not limited to patent issues), conditions are imposed on you (whether by court order, agreement or otherwise) that contradict the conditions of this License, they do not excuse you from the conditions of this License. If you cannot distribute so as to satisfy simultaneously your obligations under this License and any other pertinent obligations, then as a consequence you may not distribute the Program at all. For example, if a patent license would not permit royalty-free redistribution of the Program by all those who receive copies directly or indirectly through you, then the only way you could satisfy both it and this License would be to refrain entirely from distribution of the Program.

If any portion of this section is held invalid or unenforceable under any particular circumstance, the balance of the section is intended to apply and the section as a whole is intended to apply in other circumstances.

It is not the purpose of this section to induce you to infringe any patents or other property right claims or to contest validity of any such claims; this section has the sole purpose of protecting the integrity of the free software distribution system, which is implemented by public license practices. Many people have made generous contributions to the wide range of software distributed through that system in reliance on consistent application of that system; it is up to the author/donor to decide if he or she is willing to distribute software through any other system and a licensee cannot impose that choice.

This section is intended to make thoroughly clear what is believed to be a consequence of the rest of this License.

8. If the distribution and/or use of the Program is restricted in certain countries either by patents or by copyrighted interfaces, the original copyright holder who places the Program under this License may add an explicit geographical distribution limitation excluding those countries, so that distribution is permitted only in or among countries not thus excluded. In such case, this License incorporates the limitation as if written in the body of this License.

9. The Free Software Foundation may publish revised and/or new versions of the General Public License from time to time. Such new versions will be similar in spirit to the present version, but may differ in detail to address new problems or concerns.

Each version is given a distinguishing version number. If the Program specifies a version number of this License which applies to it and "any later version", you have the option of following the terms and conditions either of that version or of any later version published by the Free Software Foundation. If the Program does not specify a version number of this License, you may choose any version ever published by the Free Software Foundation.

本機で使われるソフトウェアライセンス情報 (つづき)

10. If you wish to incorporate parts of the Program into other free programs whose distribution conditions are different, write to the author to ask for permission. For software which is copyrighted by the Free Software Foundation, write to the Free Software Foundation; we sometimes make exceptions for this. Our decision will be guided by the two goals of preserving the free status of all derivatives of our free software and of promoting the sharing and reuse of software generally.

NO WARRANTY

11. BECAUSE THE PROGRAM IS LICENSED FREE OF CHARGE, THERE IS NO WARRANTY FOR THE PROGRAM, TO THE EXTENT PERMITTED BY APPLICABLE LAW. EXCEPT WHEN OTHERWISE STATED IN WRITING THE COPYRIGHT HOLDERS AND/OR OTHER PARTIES PROVIDE THE PROGRAM "AS IS" WITHOUT WARRANTY OF ANY KIND, EITHER EXPRESSED OR IMPLIED,

INCLUDING, BUT NOT LIMITED TO, THE IMPLIED WARRANTIES OF MERCHANTABILITY AND FITNESS FOR A PARTICULAR PURPOSE. THE ENTIRE RISK AS TO THE QUALITY AND PERFORMANCE OF THE PROGRAM IS WITH YOU. SHOULD THE PROGRAM PROVE DEFECTIVE, YOU ASSUME THE COST OF ALL NECESSARY SERVICING, REPAIR OR CORRECTION.

12. IN NO EVENT UNLESS REQUIRED BY APPLICABLE LAW OR AGREED TO IN WRITING WILL ANY COPYRIGHT HOLDER, OR ANY OTHER PARTY WHO MAY MODIFY AND/OR REDISTRIBUTE THE PROGRAM AS PERMITTED ABOVE, BE LIABLE TO YOU FOR DAMAGES, INCLUDING ANY GENERAL, SPECIAL, INCIDENTAL OR CONSEQUENTIAL DAMAGES ARISING OUT OF THE USE OR INABILITY TO USE THE PROGRAM (INCLUDING BUT NOT LIMITED TO LOSS OF DATA OR DATA BEING RENDERED INACCURATE OR LOSSES SUSTAINED BY YOU OR THIRD PARTIES OR A FAILURE OF THE PROGRAM TO OPERATE WITH ANY OTHER PROGRAMS), EVEN IF SUCH HOLDER OR OTHER PARTY HAS BEEN ADVISED OF THE POSSIBILITY OF SUCH DAMAGES.

END OF TERMS AND CONDITIONS

How to Apply These Terms to Your New Programs

If you develop a new program, and you want it to be of the greatest possible use to the public, the best way to achieve this is to make it free software which everyone can redistribute and change under these terms.

To do so, attach the following notices to the program. It is safest to attach them to the start of each source file to most effectively convey the exclusion of warranty; and each file should have at least the "copyright" line and a pointer to where the full notice is found.

```
<one line to give the program's name and a brief idea of what it does.>
Copyright (C) <year> <name of author>
```

This program is free software; you can redistribute it and/or modify it under the terms of the GNU General Public License as published by the Free Software Foundation; either version 2 of the License, or (at your option) any later version.

This program is distributed in the hope that it will be useful, but WITHOUT ANY WARRANTY; without even the implied warranty of MERCHANTABILITY or FITNESS FOR A PARTICULAR PURPOSE. See the GNU General Public License for more details.

You should have received a copy of the GNU General Public License along with this program; if not, write to the Free Software Foundation, Inc., 59 Temple Place, Suite 330, Boston, MA 02111-1307 USA

Also add information on how to contact you by electronic and paper mail.

If the program is interactive, make it output a short notice like this when it starts in an interactive mode:

```
Gnomovision version 69, Copyright (C) year name of author
Gnomovision comes with ABSOLUTELY NO WARRANTY; for details type `show w'.
This is free software, and you are welcome to redistribute it
under certain conditions; type `show c' for details.
```

The hypothetical commands 'show w' and 'show c' should show the appropriate parts of the General Public License. Of course, the commands you use may be called something other than 'show w' and 'show c'; they could even be mouse-clicks or menu items—whatever suits your program.

You should also get your employer (if you work as a programmer) or your school, if any, to sign a "copyright disclaimer" for the program, if necessary. Here is a sample; alter the names:

```
Yoyodyne, Inc., hereby disclaims all copyright interest in the program
`Gnomovision' (which makes passes at compilers) written by James Hacker.
```

```
<signature of Ty Coon>, 1 April 1989
Ty Coon, President of Vice
```

This General Public License does not permit incorporating your program into proprietary programs. If your program is a subroutine library, you may consider it more useful to permit linking proprietary applications with the library. If this is what you want to do, use the GNU Library General Public License instead of this License.

Exhibit (e)

```
// Copyright (C) 2002-2013 The ANGLE Project Authors.
// All rights reserved.
```

```
Redistribution and use in source and binary forms, with or without
modification, are permitted provided that the following conditions
are met:
```

```
1. Redistributions of source code must retain the above copyright
notice, this list of conditions and the following disclaimer.
```

```
2. Redistributions in binary form must reproduce the above
copyright notice, this list of conditions and the following
disclaimer, in the documentation and/or other materials provided
with the distribution.
```

```
Neither the name of TransGaming Inc., Google Inc., 3DLabs Inc.,
Ltd., nor the names of their contributors may be used to endorse
or promote products derived from this software without specific
prior written permission.
```

```
THIS SOFTWARE IS PROVIDED BY THE COPYRIGHT HOLDERS AND CONTRIBUTORS
"AS IS" AND ANY EXPRESS OR IMPLIED WARRANTIES, INCLUDING, BUT NOT
LIMITED TO, THE IMPLIED WARRANTIES OF MERCHANTABILITY AND FITNESS
FOR A PARTICULAR PURPOSE ARE DISCLAIMED. IN NO EVENT SHALL THE
COPYRIGHT HOLDER OR CONTRIBUTORS BE LIABLE FOR ANY DIRECT, INDIRECT,
INCIDENTAL, SPECIAL, EXEMPLARY, OR CONSEQUENTIAL DAMAGES (INCLUDING,
BUT NOT LIMITED TO, PROCUREMENT OF SUBSTITUTE GOODS OR SERVICES;
LOSS OF USE, DATA, OR PROFITS; OR BUSINESS INTERRUPTION)
HOWEVER CAUSED AND ON ANY THEORY OF LIABILITY, WHETHER IN CONTRACT,
STRICT LIABILITY, OR TORT (INCLUDING NEGLIGENCE OR OTHERWISE) ARISING
IN ANY WAY OUT OF THE USE OF THIS SOFTWARE, EVEN IF ADVISED OF THE
POSSIBILITY OF SUCH DAMAGE.
```

```
C++ Big Integer Library
(see ChangeLog for version)
```

```
http://mattmccutchen.net/bigint/
```

Written and maintained by Matt McCutchen <matt@mattmccutchen.net>

You can use this library in a C++ program to do arithmetic on integers of size limited only by your computer's memory. The library provides `BigUnsigned` and `BigInteger` classes that represent nonnegative integers and signed integers, respectively. Most of the C++ arithmetic operators are overloaded for these classes, so big-integer calculations are as easy as:

```
#include "BigIntegerLibrary.hh"

BigInteger a = 65536;
cout << (a * a * a * a * a * a * a * a);

// prints 340282366920938463463374607431768211456
```

The code in "sample.cc" demonstrates the most important features of the library. To get started quickly, read the code and explanations in that file and run it. If you want more detail or a feature not shown in "sample.cc", consult the

consult the actual header and source files, which are thoroughly commented.

This library emphasizes ease of use and clarity of implementation over speed; some users will prefer `GMP` (<http://swox.com/gmp/>), which is faster. The code is intended to be reasonably portable across computers and modern C++ compilers; in particular, it uses whatever word size the computer provides (32-bit, 64-bit, or otherwise).

Compiling programs that use the library

The library consists of a folder full of C++ header files (.hh) and source files (.cc). Your own programs should #include the necessary header files and link with the source files. A makefile that builds the sample program (sample.cc) is included; you can adapt it to replace the sample with your own program.

Alternatively, you can use your own build system or IDE. In that case, you must put the library header files where the compiler will find them and arrange to have your program linked with the library source files; otherwise, you will get errors about missing header files or "undefined references". To learn how to do this, consult the documentation for the build system or IDE; don't bother asking me. Adding all the library files to your project will work in many IDEs but may not be the most desirable approach.

Resources

The library's Web site (above) provides links to released versions, the current development version, and a mailing list for release announcements, questions, bug reports, and other discussion of the library. I would be delighted to hear from you if you like this library and/or find a good use for it.

Bugs and enhancements

The library has been tested by me and others but is by no means bug-free. If you find a bug, please report it, whether it comes in the form of compiling trouble, a mathematically inaccurate result, or a memory-management blooper (since I use Java, these are altogether too common in my C++). I generally fix all reported bugs. You are also welcome to request enhancements, but I am unlikely to do substantial amounts of work on enhancements at this point.

Legal

I, Matt McCutchen, the sole author of the original Big Integer Library, waive my copyright to it, placing it in the public domain. The library comes with absolutely no warranty.

~~~~~

BoringSSL is a fork of OpenSSL. As such, large parts of it fall under OpenSSL licensing. Files that are completely new have a Google copyright and an ISC license. This license is reproduced at the bottom of this file.

Contributors to BoringSSL are required to follow the CLA rules for Chromium: <https://cla.developers.google.com/cla>

Some files from Intel are under yet another license, which is also included underneath.

The OpenSSL toolkit stays under a dual license, i.e. both the conditions of the OpenSSL License and the original SSLeay license apply to the toolkit. See below for the actual license texts. Actually both licenses are BSD-style Open Source licenses. In case of any license issues related to OpenSSL please contact [openssl-core@openssl.org](mailto:openssl-core@openssl.org).

The following are Google-internal bug numbers where explicit permission from some authors is recorded for use of their work. (This is purely for our own record keeping.)  
 27287199  
 27287880  
 27287883

### OpenSSL License

```
/*
 * Copyright (c) 1998-2011 The OpenSSL Project. All rights reserved.
 *
 * Redistribution and use in source and binary forms, with or without
 * modification, are permitted provided that the following conditions
 * are met:
 *
 * 1. Redistributions of source code must retain the above copyright
 * notice, this list of conditions and the following disclaimer.
 *
 * 2. Redistributions in binary form must reproduce the above copyright
 * notice, this list of conditions and the following disclaimer in
 * the documentation and/or other materials provided with the
 * distribution.
 *
 * 3. All advertising materials mentioning features or use of this
 * software must display the following acknowledgment:
 * * "This product includes software developed by the OpenSSL Project
 * for use in the OpenSSL Toolkit. (http://www.openssl.org/)"
 *
 * 4. The names "OpenSSL Toolkit" and "OpenSSL Project" must not be used to
 * endorse or promote products derived from this software without
 * prior written permission. For written permission, please contact
 * openssl-core@openssl.org.
 *
 * 5. Products derived from this software may not be called "OpenSSL"
 * nor may "OpenSSL" appear in their names without prior written
 * permission of the OpenSSL Project.
 *
 * 6. Redistributions of any form whatsoever must retain the following
 * acknowledgment:
 * * This product includes software developed by the OpenSSL Project
 * for use in the OpenSSL Toolkit (http://www.openssl.org/)
 *
 * THIS SOFTWARE IS PROVIDED BY THE COPYRIGHT HOLDERS AND CONTRIBUTORS
 * "AS IS" AND ANY EXPRESS OR IMPLIED WARRANTIES, INCLUDING, BUT NOT LIMITED TO, THE
 * IMPLIED WARRANTIES OF MERCHANTABILITY AND FITNESS FOR A PARTICULAR
 * PURPOSE ARE DISCLAIMED. IN NO EVENT SHALL THE OPENSSL PROJECT OR
 * ITS CONTRIBUTORS BE LIABLE FOR ANY DIRECT, INDIRECT, INCIDENTAL,
 * SPECIAL, EXEMPLARY, OR CONSEQUENTIAL DAMAGES (INCLUDING, BUT
 * NOT LIMITED TO, PROCUREMENT OF SUBSTITUTE GOODS OR SERVICES;
 * LOSS OF USE, DATA, OR PROFITS; OR BUSINESS INTERRUPTION)
 * HOWEVER CAUSED AND ON ANY THEORY OF LIABILITY, WHETHER IN CONTRACT,
 * STRICT LIABILITY, OR TORT (INCLUDING NEGLIGENCE OR OTHERWISE)
 * ARISING IN ANY WAY OUT OF THE USE OF THIS SOFTWARE, EVEN IF ADVISED
 * OF THE POSSIBILITY OF SUCH DAMAGE.
 *
 *
 * This product includes cryptographic software written by Eric Young
 * (eay@cryptsoft.com). This product includes software written by Tim
 * Hudson (tjh@cryptsoft.com).
 */

Original SSLeay License

/* Copyright (C) 1995-1998 Eric Young (eay@cryptsoft.com)
```

\* All rights reserved.  
\* This package is an SSL implementation written by Eric Young (eay@cryptsoft.com).  
\* The implementation was written so as to conform with Netscapes SSL.

\* This library is free for commercial and non-commercial use as long as the following conditions are aheared to. The following conditions apply to all code found in this distribution, be it the RC4, RSA, lhash, DES, etc., code; not just the SSL code. The SSL documentation included with this distribution is covered by the same copyright terms except that the holder is Tim Hudson (tjh@cryptsoft.com).

\* Copyright remains Eric Young's, and as such any Copyright notices in the code are not to be removed.  
\* If this package is used in a product, Eric Young should be given attribution as the author of the parts of the library used.  
\* This can be in the form of a textual message at program startup or in documentation (online or textual) provided with the package.

\* Redistribution and use in source and binary forms, with or without modification, are permitted provided that the following conditions are met:

\* 1. Redistributions of source code must retain the copyright notice, this list of conditions and the following disclaimer.

\* 2. Redistributions in binary form must reproduce the above copyright notice, this list of conditions and the following disclaimer in the documentation and/or other materials provided with the distribution.

\* 3. All advertising materials mentioning features or use of this software must display the following acknowledgement:

\* This product includes cryptographic software written by Eric Young (eay@cryptsoft.com)  
\* The word "cryptographic" can be left out if the rouines from the library being used are not cryptographic related :-)

\* 4. If you include any Windows specific code (or a derivative thereof) from the apps directory (or any code) you must include an acknowledgement: "This product includes software written by Tim Hudson (tjh@cryptsoft.com)"

\* THIS SOFTWARE IS PROVIDED BY ERIC YOUNG "AS IS" AND ANY EXPRESS OR IMPLIED WARRANTIES, INCLUDING, BUT NOT LIMITED TO, THE IMPLIED WARRANTIES OF MERCHANTABILITY AND FITNESS FOR A PARTICULAR PURPOSE ARE DISCLAIMED. IN NO EVENT SHALL THE AUTHOR OR CONTRIBUTORS BE LIABLE FOR ANY DIRECT, INDIRECT, INCIDENTAL, SPECIAL, EXEMPLARY, OR CONSEQUENTIAL DAMAGES (INCLUDING, BUT NOT LIMITED TO, PROCUREMENT OF SUBSTITUTE GOODS OR SERVICES; LOSS OF USE, DATA, OR PROFITS; OR BUSINESS INTERRUPTION) HOWEVER CAUSED AND ON ANY THEORY OF LIABILITY, WHETHER IN CONTRACT, STRICT LIABILITY, OR TORT (INCLUDING NEGLIGENCE OR OTHERWISE) ARISING IN ANY WAY OUT OF THE USE OF THIS SOFTWARE, EVEN IF ADVISED OF THE POSSIBILITY OF SUCH DAMAGE.

\* The licence and distribution terms for any publicly available version or derivative of this code cannot be changed, i.e. this code cannot simply be copied and put under another distribution licence [including the GNU Public Licence.]

ISC license used for completely new code in BoringSSL:

/\* Copyright (c) 2015, Google Inc.

\* Permission to use, copy, modify, and/or distribute this software for any purpose with or without fee is hereby granted, provided that the above copyright notice and this permission notice appear in all copies.

\* THE SOFTWARE IS PROVIDED "AS IS" AND THE AUTHOR DISCLAIMS ALL WARRANTIES WITH REGARD TO THIS SOFTWARE INCLUDING ALL IMPLIED WARRANTIES OF MERCHANTABILITY AND FITNESS. IN NO EVENT SHALL THE AUTHOR BE LIABLE FOR ANY SPECIAL, DIRECT, INDIRECT, OR CONSEQUENTIAL DAMAGES OR ANY DAMAGES WHATSOEVER RESULTING FROM LOSS OF USE, DATA OR PROFITS, WHETHER IN AN ACTION OF CONTRACT, NEGLIGENCE OR OTHER TORTIOUS ACTION, ARISING OUT OF OR IN CONNECTION WITH THE USE OR PERFORMANCE OF THIS SOFTWARE. \*/

Some files from Intel carry the following license:

# Copyright (c) 2012, Intel Corporation

# All rights reserved.

# Redistribution and use in source and binary forms, with or without modification, are permitted provided that the following conditions are met:

# \* Redistributions of source code must retain the above copyright notice, this list of conditions and the following disclaimer.

# \* Redistributions in binary form must reproduce the above copyright notice, this list of conditions and the following disclaimer in the documentation and/or other materials provided with the distribution.

# \* Neither the name of the Intel Corporation nor the names of its contributors may be used to endorse or promote products derived from this software without specific prior written permission.

# THIS SOFTWARE IS PROVIDED BY INTEL CORPORATION "AS IS" AND ANY EXPRESS OR IMPLIED WARRANTIES, INCLUDING, BUT NOT LIMITED TO, THE IMPLIED WARRANTIES OF MERCHANTABILITY AND FITNESS FOR A PARTICULAR PURPOSE ARE DISCLAIMED. IN NO EVENT SHALL INTEL CORPORATION OR CONTRIBUTORS BE LIABLE FOR ANY DIRECT, INDIRECT, INCIDENTAL, SPECIAL, EXEMPLARY, OR CONSEQUENTIAL DAMAGES (INCLUDING, BUT NOT LIMITED TO, PROCUREMENT OF SUBSTITUTE GOODS OR SERVICES; LOSS OF USE, DATA, OR PROFITS; OR BUSINESS INTERRUPTION) HOWEVER CAUSED AND ON ANY THEORY OF LIABILITY, WHETHER IN CONTRACT, STRICT LIABILITY, OR TORT (INCLUDING NEGLIGENCE OR OTHERWISE) ARISING IN ANY WAY OUT OF THE USE OF THIS SOFTWARE, EVEN IF ADVISED OF THE POSSIBILITY OF SUCH DAMAGE.

The author disclaims copyright to this source code. In place of a legal notice, here is a blessing:

May you do good and not evil.  
May you find forgiveness for yourself and forgive others.  
May you share freely, never taking more than you give.

All MurmurHash source files are placed in the public domain.

The license below applies to all other code in SMHasher:

Copyright (c) 2011 Google, Inc.

Permission is hereby granted, free of charge, to any person obtaining a copy of this software and associated documentation files (the "Software"), to deal in the Software without restriction, including without limitation the rights to use, copy, modify, merge, publish, distribute, sublicense, and/or sell copies of the Software, and to permit persons to whom the Software is furnished to do so, subject to the following conditions:

The above copyright notice and this permission notice shall be included in all copies or substantial portions of the Software.

THE SOFTWARE IS PROVIDED "AS IS", WITHOUT WARRANTY OF ANY KIND, EXPRESS OR

IMPLIED, INCLUDING BUT NOT LIMITED TO THE WARRANTIES OF MERCHANTABILITY, FITNESS FOR A PARTICULAR PURPOSE AND NONINFRINGEMENT. IN NO EVENT SHALL THE AUTHORS OR COPYRIGHT HOLDERS BE LIABLE FOR ANY CLAIM, DAMAGES OR OTHER LIABILITY, WHETHER IN AN ACTION OF CONTRACT, TORT OR OTHERWISE, ARISING FROM, OUT OF OR IN CONNECTION WITH THE SOFTWARE OR THE USE OR OTHER DEALINGS IN THE SOFTWARE.

Apache License  
Version 2.0, January 2004  
<http://www.apache.org/licenses/>

TERMS AND CONDITIONS FOR USE, REPRODUCTION, AND DISTRIBUTION

1. Definitions.

"License" shall mean the terms and conditions for use, reproduction, and distribution as defined by Sections 1 through 9 of this document.

"Licensor" shall mean the copyright owner or entity authorized by the copyright owner that is granting the License.

"Legal Entity" shall mean the union of the acting entity and all other entities that control, are controlled by, or are under common control with that entity. For the purposes of this definition, "control" means (i) the power, direct or indirect, to cause the direction or management of such entity, whether by contract or otherwise, or (ii) ownership of fifty percent (50%) or more of the outstanding shares, or (iii) beneficial ownership of such entity.

"You" (or "Your") shall mean an individual or Legal Entity exercising permissions granted by this License.

"Source" form shall mean the preferred form for making modifications, including but not limited to software source code, documentation source, and configuration files.

"Object" form shall mean any form resulting from mechanical transformation or translation of a Source form, including but not limited to compiled object code, generated documentation, and conversions to other media types.

"Work" shall mean the work of authorship, whether in Source or Object form, made available under the License, as indicated by a copyright notice that is included in or attached to the work (an example is provided in the Appendix below).

"Derivative Works" shall mean any work, whether in Source or Object form, that is based on (or derived from) the Work and for which the editorial revisions, annotations, elaborations, or other modifications represent, as a whole, an original work of authorship. For the purposes of this License, Derivative Works shall not include works that remain separable from, or merely link (or bind by name) to the interfaces of, the Work and Derivative Works thereof.

"Contribution" shall mean any work of authorship, including the original version of the Work and any modifications or additions to that Work or Derivative Works thereof, that is intentionally submitted to Licensor for inclusion in the Work by the copyright owner or by an individual or Legal Entity authorized to submit on behalf of the copyright owner. For the purposes of this definition, "submitted" means any form of electronic, verbal, or written communication sent to the Licensor or its representatives, including but not limited to communication on electronic mailing lists, source code control systems, and issue tracking systems, that are managed by, or on behalf of, the Licensor for the purpose of discussing and improving the Work, but excluding communication that is conspicuously marked or otherwise designated in writing by the copyright owner as "Not a Contribution."

"Contributor" shall mean Licensor and any individual or Legal Entity on behalf of whom a Contribution has been received by Licensor and subsequently incorporated within the Work.

2. Grant of Copyright License. Subject to the terms and conditions of this License, each Contributor hereby grants to You a perpetual, worldwide, non-exclusive, no-charge, royalty-free, irrevocable copyright license to reproduce, prepare Derivative Works of, publicly display, publicly perform, sublicense, and distribute the Work and such Derivative Works in Source or Object form.

3. Grant of Patent License. Subject to the terms and conditions of this License, each Contributor hereby grants to You a perpetual, worldwide, non-exclusive, no-charge, royalty-free, irrevocable (except as stated in this section) patent license to make, have made, use, offer to sell, sell, import, and otherwise transfer the Work, where such license applies only to those patent claims licensable by such Contributor that are necessarily infringed by their Contribution(s) alone or by combination of their Contribution(s) with the Work to which such Contribution(s) was submitted. If You institute patent litigation against any entity (including a cross-claim or counterclaim in a lawsuit) alleging that the Work or a Contribution incorporated within the Work constitutes direct or contributory patent infringement, then any patent licenses granted to You under this License for that Work shall terminate as of the date such litigation is filed.

4. Redistribution. You may reproduce and distribute copies of the Work or Derivative Works thereof in any medium, with or without modifications, and in Source or Object form, provided that You meet the following conditions:

(a) You must give any other recipients of the Work or Derivative Works a copy of this License; and

(b) You must cause any modified files to carry prominent notices stating that You changed the files; and

(c) You must retain, in the Source form of any Derivative Works that You distribute, all copyright, patent, trademark, and attribution notices from the Source form of the Work, excluding those notices that do not pertain to any part of the Derivative Works; and

(d) If the Work includes a "NOTICE" text file as part of its distribution, then any Derivative Works that You distribute must include a readable copy of the attribution notices contained within such NOTICE file, excluding those notices that do not pertain to any part of the Derivative Works, in at least one of the following places: within a NOTICE text file distributed as part of the Derivative Works; within the Source form or documentation, if provided along with the Derivative Works; or, within a display generated by the Derivative Works, if and wherever such third-party notices normally appear. The contents of the NOTICE file are for informational purposes only and do not modify the License. You may add Your own attribution notices within Derivative Works that You distribute, alongside or as an addendum to the NOTICE text from the Work, provided that such additional attribution notices cannot be construed as modifying the License.

You may add Your own copyright statement to Your modifications and may provide additional or different license terms and conditions for use, reproduction, or distribution of Your modifications, or for any such Derivative Works as a whole, provided Your use, reproduction, and distribution of the Work otherwise complies with the conditions stated in this License.

# 本機で使われるソフトウェアライセンス情報 (つづき)

5. Submission of Contributions. Unless You explicitly state otherwise, any Contribution intentionally submitted for inclusion in the Work by You to the Licensor shall be under the terms and conditions of this License, without any additional terms or conditions. Notwithstanding the above, nothing herein shall supersede or modify the terms of any separate license agreement you may have executed with Licensor regarding such Contributions.
6. Trademarks. This License does not grant permission to use the trade names, trademarks, service marks, or product names of the Licensor, except as required for reasonable and customary use in describing the origin of the Work and reproducing the content of the NOTICE file.
7. Disclaimer of Warranty. Unless required by applicable law or agreed to in writing, Licensor provides the Work (and each Contributor provides its Contributions) on an "AS IS" BASIS, WITHOUT WARRANTIES OR CONDITIONS OF ANY KIND, either express or implied, including, without limitation, any warranties or conditions of TITLE, NON-INFRINGEMENT, MERCHANTABILITY, or FITNESS FOR A PARTICULAR PURPOSE. You are solely responsible for determining the appropriateness of using or redistributing the Work and assume any risks associated with Your exercise of permissions under this License.
8. Limitation of Liability. In no event and under no legal theory, whether in tort (including negligence), contract, or otherwise, unless required by applicable law (such as deliberate and grossly negligent acts) or agreed to in writing, shall any Contributor be liable to You for damages, including any direct, indirect, special, incidental, or consequential damages of any character arising as a result of this License or out of the use or inability to use the Work (including but not limited to damages for loss of goodwill, work stoppage, computer failure or malfunction, or any and all other commercial damages or losses), even if such Contributor has been advised of the possibility of such damages.
9. Accepting Warranty or Additional Liability. While redistributing the Work or Derivative Works thereof, You may choose to offer, and charge a fee for, acceptance of support, warranty, indemnity, or other liability obligations and/or rights consistent with this License. However, in accepting such obligations, You may act only on Your own behalf and on Your sole responsibility, not on behalf of any other Contributor, and only if You agree to indemnify, defend, and hold each Contributor harmless for any liability incurred by, or claims asserted against, such Contributor by reason of your accepting any such warranty or additional liability.

## END OF TERMS AND CONDITIONS

### APPENDIX: How to apply the Apache License to your work.

To apply the Apache License to your work, attach the following boilerplate notice, with the fields enclosed by brackets [ ] replaced with your own identifying information. (Don't include the brackets!) The text should be enclosed in the appropriate comment syntax for the file format. We also recommend that a file or class name and description of purpose be included on the same "printed page" as the copyright notice for easier identification within third-party archives.

Copyright [yyyy] [name of copyright owner]

Licensed under the Apache License, Version 2.0 (the "License"); you may not use this file except in compliance with the License. You may obtain a copy of the License at

<http://www.apache.org/licenses/LICENSE-2.0>

Unless required by applicable law or agreed to in writing, software distributed under the License is distributed on an "AS IS" BASIS, WITHOUT WARRANTIES OR CONDITIONS OF ANY KIND, either express or implied. See the License for the specific language governing permissions and limitations under the License.

/\* zlib.h -- interface of the 'zlib' general purpose compression library version 1.2.4, March 14th, 2010

Copyright (C) 1995-2010 Jean-loup Gailly and Mark Adler

This software is provided 'as-is', without any express or implied warranty. In no event will the authors be held liable for any damages arising from the use of this software.

Permission is granted to anyone to use this software for any purpose, including commercial applications, and to alter it and redistribute it freely, subject to the following restrictions:

1. The origin of this software must not be misrepresented; you must not claim that you wrote the original software. If you use this software in a product, an acknowledgment in the product documentation would be appreciated but is not required.
2. Altered source versions must be plainly marked as such, and must not be misrepresented as being the original software.
3. This notice may not be removed or altered from any source distribution.

Jean-loup Gailly  
Mark Adler

\*/

mozzconf.h is distributed under the MPL 1.1/GPL 2.0/LGPL 2.1 tri-license.

D-Bus is licensed to you under your choice of the Academic Free License version 2.1, or the GNU General Public License version 2 (or, at your option any later version).

Both licenses are included here. Some of the standalone binaries are under the GPL only; in particular, but not limited to, tools/dbus-cleanup-sockets.c and test/decode-gcov.c. Each source code file is marked with the proper copyright information - if you find a file that isn't marked please bring it to our attention.

The Academic Free License  
v. 2.1

This Academic Free License (the "License") applies to any original work of authorship (the "Original Work") whose owner (the "Licensor") has placed the following notice immediately following the copyright notice for the Original Work:

Licensed under the Academic Free License version 2.1

- 1) Grant of Copyright License. Licensor hereby grants You a world-wide, royalty-free, non-exclusive, perpetual, sublicenseable license to do the following:
  - a) to reproduce the Original Work in copies;
  - b) to prepare derivative works ("Derivative Works") based upon the Original Work;
  - c) to distribute copies of the Original Work and Derivative Works to the public;
  - d) to perform the Original Work publicly; and

e) to display the Original Work publicly.

- 2) Grant of Patent License. Licensor hereby grants You a world-wide, royalty-free, non-exclusive, perpetual, sublicenseable license, under patent claims owned or controlled by the Licensor that are embodied in the Original Work as furnished by the Licensor, to make, use, sell and offer for sale the Original Work and Derivative Works.

- 3) Grant of Source Code License. The term "Source Code" means the preferred form of the Original Work for making modifications to it and all available documentation describing how to modify the Original Work. Licensor hereby agrees to provide a machine-readable copy of the Source Code of the Original Work along with each copy of the Original Work that Licensor distributes. Licensor reserves the right to satisfy this obligation by placing a machine-readable copy of the Source Code in an information repository reasonably calculated to permit inexpensive and convenient access by You for as long as Licensor continues to distribute the Original Work, and by publishing the address of that information repository in a notice immediately following the copyright notice that applies to the Original Work.

- 4) Exclusions From License Grant. Neither the names of Licensor, nor the names of any contributors to the Original Work, nor any of their trademarks or service marks, may be used to endorse or promote products derived from this Original Work without express prior written permission of the Licensor. Nothing in this License shall be deemed to grant any rights to trademarks, copyrights, patents, trade secrets or any other intellectual property of Licensor except as expressly stated herein. No patent license is granted to make, use, sell or offer to sell, embodiments of any patent claims other than the licensed claims defined in Section 2. No right is granted to the trademarks of Licensor even if such marks are included in the Original Work. Nothing in this License shall be interpreted to prohibit Licensor from licensing under different terms from this License any Original Work that Licensor otherwise would have a right to license.

- 5) This section intentionally omitted.

- 6) Attribution Rights. You must retain, in the Source Code of any Derivative Works that You create, all copyright, patent or trademark notices from the Source Code of the Original Work, as well as any notices of licensing and any descriptive text identified therein as an Attribution Notice. You must cause the Source Code for any Derivative Works that You create to carry a prominent Attribution Notice reasonably calculated to inform recipients that You have modified the Original Work.

- 7) Warranty of Provenance and Disclaimer of Warranty. Licensor warrants that the copyright in and to the Original Work and the patent rights granted herein by Licensor are owned by the Licensor or are sublicensed to You under the terms of this License with the permission of the contributor(s) of those copyrights and patent rights. Except as expressly stated in the immediately preceding sentence, the Original Work is provided under this License on an "AS IS" BASIS and WITHOUT WARRANTY, either express or implied, including, without limitation, the warranties of NON-INFRINGEMENT, MERCHANTABILITY or FITNESS FOR A PARTICULAR PURPOSE. THE ENTIRE RISK AS TO THE QUALITY OF THE ORIGINAL WORK IS WITH YOU. This DISCLAIMER OF WARRANTY constitutes an essential part of this License. No license to Original Work is granted hereunder except under this disclaimer.

- 8) Limitation of Liability. Under no circumstances and under no legal theory, whether in tort (including negligence), contract, or otherwise, shall the Licensor be liable to any person for any direct, indirect, special, incidental, or consequential damages of any character arising as a result of this License or the use of the Original Work, including, without limitation, damages for loss of goodwill, work stoppage, computer failure or malfunction, or any and all other commercial damages or losses. This limitation of liability shall not apply to liability for death or personal injury resulting from Licensor's negligence to the extent applicable law prohibits such limitation. Some jurisdictions do not allow the exclusion or limitation of incidental or consequential damages, so this exclusion and limitation may not apply to You.

- 9) Acceptance and Termination. If You distribute copies of the Original Work or a Derivative Work, You must make a reasonable effort under the circumstances to obtain the express assent of recipients to the terms of this License. Nothing else but this License (or another written agreement between Licensor and You) grants You permission to create Derivative Works based upon the Original Work or to exercise any of the rights granted in Section 1 herein, and any attempt to do so except under the terms of this License (or another written agreement between Licensor and You) is expressly prohibited by U.S. copyright law, the equivalent laws of other countries, and by international treaty. Therefore, by exercising any of the rights granted to You in Section 1 herein, You indicate Your acceptance of this License and all of its terms and conditions.

- 10) Termination for Patent Action. This License shall terminate automatically and You may no longer exercise any of the rights granted to You by this License as of the date You commence an action, including a cross-claim or counterclaim, against Licensor or any licensee alleging that the Original Work infringes a patent. This termination provision shall not apply for an action alleging patent infringement by combinations of the Original Work with other software or hardware.

- 11) Jurisdiction, Venue and Governing Law. Any action or suit relating to this License may be brought only in the courts of a jurisdiction wherein the Licensor resides or in which Licensor conducts its primary business, and under the laws of that jurisdiction excluding its conflict-of-law provisions. The application of the United Nations Convention on Contracts for the International Sale of Goods is expressly excluded. Any use of the Original Work outside the scope of this License or after its termination shall be subject to the requirements and penalties of the U.S. Copyright Act, 17 U.S.C. 107 et seq., the equivalent laws of other countries, and international treaty. This section shall survive the termination of this License.

- 12) Attorneys Fees. In any action to enforce the terms of this License or seeking damages relating thereto, the prevailing party shall be entitled to recover its costs and expenses, including, without limitation, reasonable attorneys' fees and costs incurred in connection with such action, including any appeal of such action. This section shall survive the termination of this License.

- 13) Miscellaneous. This License represents the complete agreement concerning the subject matter hereof. If any provision of this License is held to be unenforceable, such provision shall be reformed only to the extent necessary to make it enforceable.

- 14) Definition of "You" in This License. "You" throughout this License, whether in upper or lower case, means an individual or a legal entity exercising rights under, and complying with all of the terms of, this License. For legal entities, "You" includes any entity that controls, is controlled by, or is under common control with you. For purposes of this definition, "control" means (i) the power, direct or indirect, to cause the direction or management of such entity, whether by contract or otherwise, or (ii) ownership of fifty percent (50%) or more of the outstanding shares, or (iii) beneficial ownership of such entity.

- 15) Right to Use. You may use the Original Work in all ways not otherwise restricted or conditioned by this License or by law, and Licensor promises not to interfere with or be responsible for such uses by You.

This License is Copyright (C) 2003-2004 Lawrence E. Rosen. All rights

reserved. Permission is hereby granted to copy and distribute this license without modification. This license may not be modified without the express written permission of its copyright owner.

END OF ACADEMIC FREE LICENSE. The following is intended to describe the essential differences between the Academic Free License (AFL) version 1.0 and other open source licenses:

The Academic Free License is similar to the BSD, MIT, UoI/NCSA and Apache licenses in many respects but it is intended to solve a few problems with those licenses.

\* The AFL is written so as to make it clear what software is being licensed (by the inclusion of a statement following the copyright notice in the software). This way, the license functions better than a template license. The BSD, MIT and UoI/NCSA licenses apply to unidentified software.

\* The AFL contains a complete copyright grant to the software. The BSD and Apache licenses are vague and incomplete in that respect.

\* The AFL contains a complete patent grant to the software. The BSD, MIT, UoI/NCSA and Apache licenses rely on an implied patent license and contain no explicit patent grant.

\* The AFL makes it clear that no trademark rights are granted to the licensor's trademarks. The Apache license contains such a provision, but the BSD, MIT and UoI/NCSA licenses do not.

\* The AFL includes the warranty by the licensor that it either owns the copyright or that it is distributing the software under a license. None of the other licenses contain that warranty. All other warranties are disclaimed, as is the case for the other licenses.

\* The AFL is itself copyrighted (with the right granted to copy and distribute without modification). This ensures that the owner of the copyright to the license will control changes. The Apache license contains a copyright notice, but the BSD, MIT and UoI/NCSA licenses do not.

START OF GNU GENERAL PUBLIC LICENSE

GNU GENERAL PUBLIC LICENSE  
Version 2, June 1991

Copyright (C) 1989, 1991 Free Software Foundation, Inc.  
51 Franklin Street, Fifth Floor, Boston, MA 02110-1301 USA

Everyone is permitted to copy and distribute verbatim copies of this license document, but changing it is not allowed.

The licenses for most software are designed to take away your freedom to share and change it. By contrast, the GNU General Public License is intended to guarantee your freedom to share and change free software—to make sure the software is free for all its users. This General Public License applies to most of the Free Software Foundation's software and to any other program whose authors commit to using it. (Some other Free Software Foundation software is covered by the GNU Library General Public License instead.) You can apply it to your programs, too.

When we speak of free software, we are referring to freedom, not price. Our General Public Licenses are designed to make sure that you have the freedom to distribute copies of free software (and charge for this service if you wish), that you receive source code or can get it if you want it, that you can change the software or use pieces of it in new free programs; and that you know you can do these things.

To protect your rights, we need to make restrictions that forbid anyone to deny you these rights or to ask you to surrender the rights. These restrictions translate to certain responsibilities for you if you distribute copies of the software, or if you modify it.

For example, if you distribute copies of such a program, whether gratis or for a fee, you must give the recipients all the rights that you have. You must make sure that they, too, receive or can get the source code. And you must show them these terms so they know their rights.

We protect your rights with two steps: (1) copyright the software, and (2) offer you this license which gives you legal permission to copy, distribute and/or modify the software.

Also, for each author's protection and ours, we want to make certain that everyone understands that there is no warranty for this free software. If the software is modified by someone else and passed on, we want its recipients to know that what they have is not the original, so that any problems introduced by others will not reflect on the original authors' reputations.

Finally, any free program is threatened constantly by software patents. We wish to avoid the danger that redistributors of a free program will individually obtain patent licenses, in effect making the program proprietary. To prevent this, we have made it clear that any patent must be licensed for everyone's free use or not licensed at all.

The precise terms and conditions for copying, distribution and modification follow.

GNU GENERAL PUBLIC LICENSE  
TERMS AND CONDITIONS FOR COPYING, DISTRIBUTION AND MODIFICATION

0. This License applies to any program or other work which contains a notice placed by the copyright holder saying it may be distributed under the terms of this General Public License. The "Program", below, refers to any such program or work, and a "work based on the Program" means either the Program or any derivative work under copyright law: that is to say, a work containing the Program or a portion of it, either verbatim or with modifications and/or translated into another language. (Hereinafter, translation is included without limitation in the term "modification".) Each licensee is addressed as "you".

Activities other than copying, distribution and modification are not covered by this License; they are outside its scope. The act of running the Program is not restricted, and the output from the Program is covered only if its contents constitute a work based on the Program (independent of having been made by running the Program). Whether that is true depends on what the Program does.

1. You may copy and distribute verbatim copies of the Program's source code as you receive it, in any medium, provided that you conspicuously and appropriately publish on each copy an appropriate copyright notice and disclaimer of warranty; keep intact all the notices that refer to this License and to the absence of any warranty; and give any other recipients of the Program a copy of this License along with the Program.

You may charge a fee for the physical act of transferring a copy, and you may at your option offer warranty protection in exchange for a fee.

2. You may modify your copy or copies of the Program or any portion of it, thus forming a work based on the Program, and copy and distribute such modifications or work under the terms of Section 1 above, provided that you also meet all of these conditions:

a) You must cause the modified files to carry prominent notices stating that you changed the files and the date of any change.

b) You must cause any work that you distribute or publish, that in whole or in part contains or is derived from the Program or any part thereof, to be licensed as a whole at no charge to all third parties under the terms of this License.

c) If the modified program normally starts commands interactively when run, you must cause it, when started running for such interactive use in the most ordinary way, to print or display an announcement including an appropriate copyright notice and a notice that there is no warranty (or else, saying that you provide a warranty) and that users may redistribute the program under these conditions, and telling the user how to view a copy of this License. (Exception: if the Program itself is interactive but does not normally print such an announcement, your work based on the Program is not required to print an announcement.)

These requirements apply to the modified work as a whole. If identifiable sections of that work are not derived from the Program, and can be reasonably considered independent and separate works in themselves, then this License, and its terms, do not apply to those sections when you distribute them as separate works. But when you distribute the same sections as part of a whole which is a work based on the Program, the distribution of the whole must be on the terms of this License, whose permissions for other licensees extend to the entire whole, and thus to each and every part regardless of who wrote it.

Thus, it is not the intent of this section to claim rights or contest your rights to work written entirely by you; rather, the intent is to exercise the right to control the distribution of derivative or collective works based on the Program.

In addition, mere aggregation of another work not based on the Program with the Program (or with a work based on the Program) on a volume of a storage or distribution medium does not bring the other work under the scope of this License.

3. You may copy and distribute the Program (or a work based on it, under Section 2) in object code or executable form under the terms of Sections 1 and 2 above provided that you also do one of the following:

a) Accompany it with the complete corresponding machine-readable source code, which must be distributed under the terms of Sections 1 and 2 above on a medium customarily used for software interchange; or,

b) Accompany it with a written offer, valid for at least three years, to give any third party, for a charge no more than your cost of physically performing source distribution, a complete machine-readable copy of the corresponding source code, to be distributed under the terms of Sections 1 and 2 above on a medium customarily used for software interchange; or,

c) Accompany it with the information you received as to the offer to distribute corresponding source code. (This alternative is allowed only for noncommercial distribution and only if you received the program in object code or executable form with such an offer, in accord with Subsection b) above.)

The source code for a work means the preferred form of the work for making modifications to it. For an executable work, complete source code means all the source code for all modules it contains, plus any associated interface definition files, plus the scripts used to control compilation and installation of the executable. However, as a special exception, the source code distributed need not include anything that is normally distributed (in either source or binary form) with the major components (compiler, kernel, and so on) of the operating system on which the executable runs, unless that component itself accompanies the executable.

If distribution of executable or object code is made by offering access to copy from a designated place, then offering equivalent access to copy the source code from the same place counts as distribution of the source code, even though third parties are not compelled to copy the source along with the object code.

4. You may not copy, modify, sublicense, or distribute the Program except as expressly provided under this License. Any attempt otherwise to copy, modify, sublicense or distribute the Program is void, and will automatically terminate your rights under this License. However, parties who have received copies, or rights, from you under this License will not have their licenses terminated so long as such parties remain in full compliance.

5. You are not required to accept this License, since you have not signed it. However, nothing else grants you permission to modify or distribute the Program or its derivative works. These actions are prohibited by law if you do not accept this License. Therefore, by modifying or distributing the Program (or any work based on the Program), you indicate your acceptance of this License to do so, and all its terms and conditions for copying, distributing or modifying the Program or works based on it.

6. Each time you redistribute the Program (or any work based on the Program), the recipient automatically receives a license from the original licensor to copy, distribute or modify the Program subject to these terms and conditions. You may not impose any further restrictions on the recipients' exercise of the rights granted herein. You are not responsible for enforcing compliance by third parties to this License.

7. If, as a consequence of a court judgment or allegation of patent infringement or for any other reason (not limited to patent issues), conditions are imposed on you (whether by court order, agreement or otherwise) that contradict the conditions of this License, they do not excuse you from the conditions of this License. If you cannot distribute so as to satisfy simultaneously your obligations under this License and any other pertinent obligations, then as a consequence you may not distribute the Program at all. For example, if a patent license would not permit royalty-free redistribution of the Program by all those who receive copies directly or indirectly through you, then the only way you could satisfy both it and this License would be to refrain entirely from distribution of the Program.

If any portion of this section is held invalid or unenforceable under any particular circumstance, the balance of the section is intended to apply and the section as a whole is intended to apply in other circumstances.

It is not the purpose of this section to induce you to infringe any patents or other property right claims or to contest validity of any such claims; this section has the sole purpose of protecting the integrity of the free software distribution system, which is implemented by public license practices. Many people have made generous contributions to the wide range of software distributed through that system in reliance on consistent application of that system; it is up to the author/donor to decide if he or she is willing to distribute software through any other system and a licensee cannot impose that choice.

This section is intended to make thoroughly clear what is believed to be a consequence of the rest of this License.

8. If the distribution and/or use of the Program is restricted in certain countries either by patents or by copyrighted interfaces, the original copyright holder who places the Program under this License may add an explicit geographical distribution limitation excluding those countries, so that distribution is permitted only in or among

# 本機で使われるソフトウェアライセンス情報 (つづき)

countries not thus excluded. In such case, this License incorporates the limitation as if written in the body of this License.

9. The Free Software Foundation may publish revised and/or new versions of the General Public License from time to time. Such new versions will be similar in spirit to the present version, but may differ in detail to address new problems or concerns.

Each version is given a distinguishing version number. If the Program specifies a version number of this License which applies to it and "any later version", you have the option of following the terms and conditions either of that version or of any later version published by the Free Software Foundation. If the Program does not specify a version number of this License, you may choose any version ever published by the Free Software Foundation.

10. If you wish to incorporate parts of the Program into other free programs whose distribution conditions are different, write to the author to ask for permission. For software which is copyrighted by the Free Software Foundation, write to the Free Software Foundation; we sometimes make exceptions for this. Our decision will be guided by the two goals of preserving the free status of all derivatives of our free software and of promoting the sharing and reuse of software generally.

## NO WARRANTY

11. BECAUSE THE PROGRAM IS LICENSED FREE OF CHARGE, THERE IS NO WARRANTY FOR THE PROGRAM, TO THE EXTENT PERMITTED BY APPLICABLE LAW. EXCEPT WHEN OTHERWISE STATED IN WRITING THE COPYRIGHT HOLDERS AND/OR OTHER PARTIES PROVIDE THE PROGRAM "AS IS" WITHOUT WARRANTY OF ANY KIND, EITHER EXPRESSED OR IMPLIED, INCLUDING, BUT NOT LIMITED TO, THE IMPLIED WARRANTIES OF MERCHANTABILITY AND FITNESS FOR A PARTICULAR PURPOSE. THE ENTIRE RISK AS TO THE QUALITY AND PERFORMANCE OF THE PROGRAM IS WITH YOU. SHOULD THE PROGRAM PROVE DEFECTIVE, YOU ASSUME THE COST OF ALL NECESSARY SERVICING, REPAIR OR CORRECTION.

12. IN NO EVENT UNLESS REQUIRED BY APPLICABLE LAW OR AGREED TO IN WRITING WILL ANY COPYRIGHT HOLDER, OR ANY OTHER PARTY WHO MAY MODIFY AND/OR REDISTRIBUTE THE PROGRAM AS PERMITTED ABOVE, BE LIABLE TO YOU FOR DAMAGES, INCLUDING ANY GENERAL, SPECIAL, INCIDENTAL OR CONSEQUENTIAL DAMAGES ARISING OUT OF THE USE OR INABILITY TO USE THE PROGRAM (INCLUDING BUT NOT LIMITED TO LOSS OF DATA OR DATA BEING RENDERED INACCURATE OR LOSSES SUSTAINED BY YOU OR THIRD PARTIES OR A FAILURE OF THE PROGRAM TO OPERATE WITH ANY OTHER PROGRAMS), EVEN IF SUCH HOLDER OR OTHER PARTY HAS BEEN ADVISED OF THE POSSIBILITY OF SUCH DAMAGES.

END OF TERMS AND CONDITIONS

## How to Apply These Terms to Your New Programs

If you develop a new program, and you want it to be of the greatest possible use to the public, the best way to achieve this is to make it free software which everyone can redistribute and change under these terms.

To do so, attach the following notices to the program. It is safest to attach them to the start of each source file to most effectively convey the exclusion of warranty; and each file should have at least the "copyright" line and a pointer to where the full notice is found.

```
<one line to give the program's name and a brief idea of what it does.>
Copyright (C) <year> <name of author>
```

This program is free software; you can redistribute it and/or modify it under the terms of the GNU General Public License as published by the Free Software Foundation; either version 2 of the License, or (at your option) any later version.

This program is distributed in the hope that it will be useful, but WITHOUT ANY WARRANTY; without even the implied warranty of MERCHANTABILITY or FITNESS FOR A PARTICULAR PURPOSE. See the GNU General Public License for more details.

You should have received a copy of the GNU General Public License along with this program; if not, write to the Free Software Foundation, Inc., 51 Franklin Street, Fifth Floor, Boston, MA 02110-1301 USA

Also add information on how to contact you by electronic and paper mail.

If the program is interactive, make it output a short notice like this when it starts in an interactive mode:

```
Gnomovision version 69, Copyright (C) year name of author
Gnomovision comes with ABSOLUTELY NO WARRANTY; for details type `show w'.
This is free software, and you are welcome to redistribute it
under certain conditions; type `show c' for details.
```

The hypothetical commands `show w' and `show c' should show the appropriate parts of the General Public License. Of course, the commands you use may be called something other than `show w' and `show c'; they could even be mouse-clicks or menu items—whatever suits your program.

You should also get your employer (if you work as a programmer) or your school, if any, to sign a "copyright disclaimer" for the program, if necessary. Here is a sample; alter the names:

```
Yoyodyne, Inc., hereby disclaims all copyright interest in the program
`Gnomovision' (which makes passes at compilers) written by James Hacker.
```

```
<signature of Ty Coon>, 1 April 1989
Ty Coon, President of Vice
```

This General Public License does not permit incorporating your program into proprietary programs. If your program is a subroutine library, you may consider it more useful to permit linking proprietary applications with the library. If this is what you want to do, use the GNU Library General Public License instead of this License.

```
/* Copyright (c) 2008-2009, Google Inc.
 * All rights reserved.
```

```
* Redistribution and use in source and binary forms, with or without
 * modification, are permitted provided that the following conditions are
 * met:
```

```
* * Redistributions of source code must retain the above copyright
 * notice, this list of conditions and the following disclaimer.
 * * Neither the name of Google Inc. nor the names of its
 * contributors may be used to endorse or promote products derived from
 * this software without specific prior written permission.
```

```
* THIS SOFTWARE IS PROVIDED BY THE COPYRIGHT HOLDERS AND CONTRIBUTORS
 * "AS IS" AND ANY EXPRESS OR IMPLIED WARRANTIES, INCLUDING, BUT NOT
 * LIMITED TO, THE IMPLIED WARRANTIES OF MERCHANTABILITY AND FITNESS FOR
 * A PARTICULAR PURPOSE ARE DISCLAIMED. IN NO EVENT SHALL THE COPYRIGHT
 * OWNER OR CONTRIBUTORS BE LIABLE FOR ANY DIRECT, INDIRECT, INCIDENTAL,
 * SPECIAL, EXEMPLARY, OR CONSEQUENTIAL DAMAGES (INCLUDING, BUT NOT
 * LIMITED TO, PROCUREMENT OF SUBSTITUTE GOODS OR SERVICES; LOSS OF USE,
 * DATA, OR PROFITS; OR BUSINESS INTERRUPTION) HOWEVER CAUSED AND ON ANY
 * THEORY OF LIABILITY, WHETHER IN CONTRACT, STRICT LIABILITY, OR TORT
```

```
*(INCLUDING NEGLIGENCE OR OTHERWISE) ARISING IN ANY WAY OUT OF THE USE
 * OF THIS SOFTWARE, EVEN IF ADVISED OF THE POSSIBILITY OF SUCH DAMAGE.
```

```
*
 * ---
 * Author: Kostya Serebryany
 */
```

Copyright (c) 1998-2000 Thai Open Source Software Center Ltd and Clark Cooper  
Copyright (c) 2001-2017 Expat maintainers

Permission is hereby granted, free of charge, to any person obtaining a copy of this software and associated documentation files (the "Software"), to deal in the Software without restriction, including without limitation the rights to use, copy, modify, merge, publish, distribute, sublicense, and/or sell copies of the Software, and to permit persons to whom the Software is furnished to do so, subject to the following conditions:

The above copyright notice and this permission notice shall be included in all copies or substantial portions of the Software.

THE SOFTWARE IS PROVIDED "AS IS", WITHOUT WARRANTY OF ANY KIND, EXPRESS OR IMPLIED, INCLUDING BUT NOT LIMITED TO THE WARRANTIES OF MERCHANTABILITY, FITNESS FOR A PARTICULAR PURPOSE AND NONINFRINGEMENT. IN NO EVENT SHALL THE AUTHORS OR COPYRIGHT HOLDERS BE LIABLE FOR ANY CLAIM, DAMAGES OR OTHER LIABILITY, WHETHER IN AN ACTION OF CONTRACT, TORT OR OTHERWISE, ARISING FROM, OUT OF OR IN CONNECTION WITH THE SOFTWARE OR THE USE OR OTHER DEALINGS IN THE SOFTWARE.

```
// Copyright 2014 PDFium Authors. All rights reserved.
```

```
// Redistribution and use in source and binary forms, with or without
// modification, are permitted provided that the following conditions are
// met:
```

```
// * Redistributions of source code must retain the above copyright
// notice, this list of conditions and the following disclaimer.
```

```
// * Redistributions in binary form must reproduce the above
// copyright notice, this list of conditions and the following disclaimer
// in the documentation and/or other materials provided with the
// distribution.
```

```
// * Neither the name of Google Inc. nor the names of its
// contributors may be used to endorse or promote products derived from
// this software without specific prior written permission.
```

```
// THIS SOFTWARE IS PROVIDED BY THE COPYRIGHT HOLDERS AND CONTRIBUTORS
// "AS IS" AND ANY EXPRESS OR IMPLIED WARRANTIES, INCLUDING, BUT NOT
// LIMITED TO, THE IMPLIED WARRANTIES OF MERCHANTABILITY AND FITNESS FOR
// A PARTICULAR PURPOSE ARE DISCLAIMED. IN NO EVENT SHALL THE COPYRIGHT
// OWNER OR CONTRIBUTORS BE LIABLE FOR ANY DIRECT, INDIRECT, INCIDENTAL,
// SPECIAL, EXEMPLARY, OR CONSEQUENTIAL DAMAGES (INCLUDING, BUT NOT
// LIMITED TO, PROCUREMENT OF SUBSTITUTE GOODS OR SERVICES; LOSS OF USE,
// DATA, OR PROFITS; OR BUSINESS INTERRUPTION) HOWEVER CAUSED AND ON ANY
// THEORY OF LIABILITY, WHETHER IN CONTRACT, STRICT LIABILITY, OR TORT
// (INCLUDING NEGLIGENCE OR OTHERWISE) ARISING IN ANY WAY OUT OF THE USE
// OF THIS SOFTWARE, EVEN IF ADVISED OF THE POSSIBILITY OF SUCH DAMAGE.
```

## GNU LESSER GENERAL PUBLIC LICENSE Version 2.1, February 1999

Copyright (C) 1991, 1999 Free Software Foundation, Inc.  
51 Franklin Street, Fifth Floor, Boston, MA 02110-1301 USA  
Everyone is permitted to copy and distribute verbatim copies of this license document, but changing it is not allowed.

[This is the first released version of the Lesser GPL. It also counts as the successor of the GNU Library Public License, version 2, hence the version number 2.1.]

### Preamble

The licenses for most software are designed to take away your freedom to share and change it. By contrast, the GNU General Public Licenses are intended to guarantee your freedom to share and change free software—to make sure the software is free for all its users.

This license, the Lesser General Public License, applies to some specially designated software packages—typically libraries—of the Free Software Foundation and other authors who decide to use it. You can use it too, but we suggest you first think carefully about whether this license or the ordinary General Public License is the better strategy to use in any particular case, based on the explanations below.

When we speak of free software, we are referring to freedom of use, not price. Our General Public Licenses are designed to make sure that you have the freedom to distribute copies of free software (and charge for this service if you wish); that you receive source code or can get it if you want it; that you can change the software and use pieces of it in new free programs; and that you are informed that you can do these things.

To protect your rights, we need to make restrictions that forbid distributors to deny you these rights or to ask you to surrender these rights. These restrictions translate to certain responsibilities for you if you distribute copies of the library or if you modify it.

For example, if you distribute copies of the library, whether gratis or for a fee, you must give the recipients all the rights that we gave you. You must make sure that they, too, receive or can get the source code. If you link other code with the library, you must provide complete object files to the recipients, so that they can relink them with the library after making changes to the library and recompiling it. And you must show them these terms so they know their rights.

We protect your rights with a two-step method: (1) we copyright the library, and (2) we offer you this license, which gives you legal permission to copy, distribute and/or modify the library.

To protect each distributor, we want to make it very clear that there is no warranty for the free library. Also, if the library is modified by someone else and passed on, the recipients should know that what they have is not the original version, so that the original author's reputation will not be affected by problems that might be introduced by others.

Finally, software patents pose a constant threat to the existence of any free program. We wish to make sure that a company cannot effectively restrict the users of a free program by obtaining a restrictive license from a patent holder. Therefore, we insist that any patent license obtained for a version of the library must be consistent with the full freedom of use specified in this license.

Most GNU software, including some libraries, is covered by the ordinary GNU General Public License. This license, the GNU Lesser General Public License, applies to certain designated libraries, and is quite different from the ordinary General Public License. We use this license for certain libraries in order to permit linking those libraries into non-free programs.

When a program is linked with a library, whether statically or using a shared library, the combination of the two is legally speaking a combined work, a derivative of the original library. The ordinary General Public License therefore permits such linking only if the entire combination fits its criteria of freedom. The Lesser General Public License permits more lax criteria for linking other code with the library.

We call this license the "Lesser" General Public License because it does less to protect the user's freedom than the ordinary General Public License. It also provides other free software developers less of an advantage over competing non-free programs. These disadvantages are the reason we use the ordinary General Public License for many libraries. However, the Lesser license provides advantages in certain special circumstances.

For example, on rare occasions, there may be a special need to encourage the widest possible use of a certain library, so that it becomes a de-facto standard. To achieve this, non-free programs must be allowed to use the library. A more frequent case is that a free library does the same job as widely used non-free libraries. In this case, there is little to gain by limiting the free library to free software only, so we use the Lesser General Public License.

In other cases, permission to use a particular library in non-free programs enables a greater number of people to use a large body of free software. For example, permission to use the GNU C Library in non-free programs enables many more people to use the whole GNU operating system, as well as its variant, the GNU/Linux operating system.

Although the Lesser General Public License is less protective of the users' freedom, it does ensure that the user of a program that is linked with the Library has the freedom and the wherewithal to run that program using a modified version of the Library.

The precise terms and conditions for copying, distribution and modification follow. Pay close attention to the difference between a "work based on the library" and a "work that uses the library". The former contains code derived from the library, whereas the latter must be combined with other libraries in order to run.

#### GNU LESSER GENERAL PUBLIC LICENSE TERMS AND CONDITIONS FOR COPYING, DISTRIBUTION AND MODIFICATION

0. This License Agreement applies to any software library or other program which contains a notice placed by the copyright holder or other authorized party saying it may be distributed under the terms of this Lesser General Public License (also called "this License"). Each licensee is addressed as "you".

A "library" means a collection of software functions and/or data prepared so as to be conveniently linked with application programs (which use some of those functions and data) to form executables.

The "Library", below, refers to any such software library or work which has been distributed under these terms. A "work based on the Library" means either the Library or any derivative work under copyright law: that is to say, a work containing the Library or a portion of it, either verbatim or with modifications and/or translated straightforwardly into another language. (Hereinafter, translation is included without limitation in the term "modification".)

"Source code" for a work means the preferred form of the work for making modifications to it. For a library, complete source code means all the source code for all modules it contains, plus any associated interface definition files, plus the scripts used to control compilation and installation of the library.

Activities other than copying, distribution and modification are not covered by this License; they are outside its scope. The act of running a program using the Library is not restricted, and output from such a program is covered only if its contents constitute a work based on the Library (independent of the use of the Library in a tool for writing it). Whether that is true depends on what the Library does and what the program that uses the Library does.

1. You may copy and distribute verbatim copies of the Library's complete source code as you receive it, in any medium, provided that you conspicuously and appropriately publish on each copy an appropriate copyright notice and disclaimer of warranty; keep intact all the notices that refer to this License and to the absence of any warranty; and distribute a copy of this License along with the Library.

You may charge a fee for the physical act of transferring a copy, and you may at your option offer warranty protection in exchange for a fee.

2. You may modify your copy or copies of the Library or any portion of it, thus forming a work based on the Library, and copy and distribute such modifications or work under the terms of Section 1 above, provided that you also meet all of these conditions:

- The modified work must itself be a software library.
- You must cause the files modified to carry prominent notices stating that you changed the files and the date of any change.
- You must cause the whole of the work to be licensed at no charge to all third parties under the terms of this License.
- If a facility in the modified Library refers to a function or a table of data to be supplied by an application program that uses the facility, other than as an argument passed when the facility is invoked, then you must make a good faith effort to ensure that, in the event an application does not supply such function or table, the facility still operates, and performs whatever part of its purpose remains meaningful.

(For example, a function in a library to compute square roots has a purpose that is entirely well-defined independent of the application. Therefore, Subsection 2d requires that any application-supplied function or table used by this function must be optional: if the application does not supply it, the square root function must still compute square roots.)

These requirements apply to the modified work as a whole. If identifiable sections of that work are not derived from the Library and can be reasonably considered independent and separate works in themselves, then this License, and its terms, do not apply to those sections when you distribute them as separate works. But when you distribute the same sections as part of a whole which is a work based on the Library, the distribution of the whole must be on the terms of this License, whose permissions for other licensees extend to the entire whole, and thus to each and every part regardless of who wrote

it.

Thus, it is not the intent of this section to claim rights or contest your rights to work written entirely by you; rather, the intent is to exercise the right to control the distribution of derivative or collective works based on the Library.

In addition, mere aggregation of another work not based on the Library with the Library (or with a work based on the Library) on a volume of a storage or distribution medium does not bring the other work under the scope of this License.

3. You may opt to apply the terms of the ordinary GNU General Public License instead of this License to a given copy of the Library. To do this, you must alter all the notices that refer to this License, so that they refer to the ordinary GNU General Public License, version 2, instead of to this License. (If a newer version than version 2 of the ordinary GNU General Public License has appeared, then you can specify that version instead if you wish.) Do not make any other change in these notices.

Once this change is made in a given copy, it is irreversible for that copy, so the ordinary GNU General Public License applies to all subsequent copies and derivative works made from that copy.

This option is useful when you wish to copy part of the code of the Library into a program that is not a library.

4. You may copy and distribute the Library (or a portion or derivative of it, under Section 2) in object code or executable form under the terms of Sections 1 and 2 above provided that you accompany it with the complete corresponding machine-readable source code, which must be distributed under the terms of Sections 1 and 2 above on a medium customarily used for software interchange.

If distribution of object code is made by offering access to copy from a designated place, then offering equivalent access to copy the source code from the same place satisfies the requirement to distribute the source code, even though third parties are not compelled to copy the source along with the object code.

5. A program that contains no derivative of any portion of the Library, but is designed to work with the Library by being compiled or linked with it, is called a "work that uses the Library". Such a work, in isolation, is not a derivative work of the Library, and therefore falls outside the scope of this License.

However, linking a "work that uses the Library" with the Library creates an executable that is a derivative of the Library (because it contains portions of the Library), rather than a "work that uses the library". The executable is therefore covered by this License. Section 6 states terms for distribution of such executables.

When a "work that uses the Library" uses material from a header file that is part of the Library, the object code for the work may be a derivative work of the Library even though the source code is not. Whether this is true is especially significant if the work can be linked without the Library, or if the work is itself a library. The threshold for this to be true is not precisely defined by law.

If such an object file uses only numerical parameters, data structure layouts and accessors, and small macros and small inline functions (ten lines or less in length), then the use of the object file is unrestricted, regardless of whether it is legally a derivative work. (Executables containing this object code plus portions of the Library will still fall under Section 6.)

Otherwise, if the work is a derivative of the Library, you may distribute the object code for the work under the terms of Section 6. Any executables containing that work also fall under Section 6, whether or not they are linked directly with the Library itself.

6. As an exception to the Sections above, you may also combine or link a "work that uses the Library" with the Library to produce a work containing portions of the Library, and distribute that work under terms of your choice, provided that the terms permit modification of the work for the customer's own use and reverse engineering for debugging such modifications.

You must give prominent notice with each copy of the work that the Library is used in it and that the Library and its use are covered by this License. You must supply a copy of this License. If the work during execution displays copyright notices, you must include the copyright notice for the Library among them, as well as a reference directing the user to the copy of this License. Also, you must do one of these things:

- Accompany the work with the complete corresponding machine-readable source code for the Library including whatever changes were used in the work (which must be distributed under Sections 1 and 2 above); and, if the work is an executable linked with the Library, with the complete machine-readable "work that uses the Library", as object code and/or source code, so that the user can modify the Library and then relink to produce a modified executable containing the modified Library. (It is understood that the user who changes the contents of definitions files in the Library will not necessarily be able to recompile the application to use the modified definitions.)
- Use a suitable shared library mechanism for linking with the Library. A suitable mechanism is one that (1) uses at run time a copy of the library already present on the user's computer system, rather than copying library functions into the executable, and (2) will operate properly with a modified version of the library, if the user installs one, as long as the modified version is interface-compatible with the version that the work was made with.
- Accompany the work with a written offer, valid for at least three years, to give the same user the materials specified in Subsection 6a, above, for a charge no more than the cost of performing this distribution.
- If distribution of the work is made by offering access to copy from a designated place, offer equivalent access to copy the above specified materials from the same place.
- Verify that the user has already received a copy of these materials or that you have already sent this user a copy.

For an executable, the required form of the "work that uses the Library" must include any data and utility programs needed for reproducing the executable from it. However, as a special exception, the materials to be distributed need not include anything that is normally distributed (in either source or binary form) with the major components (compiler, kernel, and so on) of the operating system on which the executable runs, unless that component itself accompanies the executable.

It may happen that this requirement contradicts the license restrictions of other proprietary libraries that do not normally accompany the operating system. Such a contradiction means you cannot use both them and the Library together in an executable that you distribute.

# 本機で使われるソフトウェアライセンス情報 (つづき)

7. You may place library facilities that are a work based on the Library side-by-side in a single library together with other library facilities not covered by this License, and distribute such a combined library, provided that the separate distribution of the work based on the Library and of the other library facilities is otherwise permitted, and provided that you do these two things:

- a) Accompany the combined library with a copy of the same work based on the Library, uncombined with any other library facilities. This must be distributed under the terms of the Sections above.
- b) Give prominent notice with the combined library of the fact that part of it is a work based on the Library, and explaining where to find the accompanying uncombined form of the same work.

8. You may not copy, modify, sublicense, link with, or distribute the Library except as expressly provided under this License. Any attempt otherwise to copy, modify, sublicense, link with, or distribute the Library is void, and will automatically terminate your rights under this License. However, parties who have received copies, or rights, from you under this License will not have their licenses terminated so long as such parties remain in full compliance.

9. You are not required to accept this License, since you have not signed it. However, nothing else grants you permission to modify or distribute the Library or its derivative works. These actions are prohibited by law if you do not accept this License. Therefore, by modifying or distributing the Library (or any work based on the Library), you indicate your acceptance of this License to do so, and all its terms and conditions for copying, distributing or modifying the Library or works based on it.

10. Each time you redistribute the Library (or any work based on the Library), the recipient automatically receives a license from the original licensor to copy, distribute, link with or modify the Library subject to these terms and conditions. You may not impose any further restrictions on the recipients' exercise of the rights granted herein. You are not responsible for enforcing compliance by third parties with this License.

11. If, as a consequence of a court judgment or allegation of patent infringement or for any other reason (not limited to patent issues), conditions are imposed on you (whether by court order, agreement or otherwise) that contradict the conditions of this License, they do not excuse you from the conditions of this License. If you cannot distribute so as to satisfy simultaneously your obligations under this License and any other pertinent obligations, then as a consequence you may not distribute the Library at all. For example, if a patent license would not permit royalty-free redistribution of the Library by all those who receive copies directly or indirectly through you, then the only way you could satisfy both it and this License would be to refrain entirely from distribution of the Library.

If any portion of this section is held invalid or unenforceable under any particular circumstance, the balance of the section is intended to apply, and the section as a whole is intended to apply in other circumstances.

It is not the purpose of this section to induce you to infringe any patents or other property right claims or to contest validity of any such claims; this section has the sole purpose of protecting the integrity of the free software distribution system which is implemented by public license practices. Many people have made generous contributions to the wide range of software distributed through that system in reliance on consistent application of that system; it is up to the author/donor to decide if he or she is willing to distribute software through any other system and a licensee cannot impose that choice.

This section is intended to make thoroughly clear what is believed to be a consequence of the rest of this License.

12. If the distribution and/or use of the Library is restricted in certain countries either by patents or by copyrighted interfaces, the original copyright holder who places the Library under this License may add an explicit geographical distribution limitation excluding those countries, so that distribution is permitted only in or among countries not thus excluded. In such case, this License incorporates the limitation as if written in the body of this License.

13. The Free Software Foundation may publish revised and/or new versions of the Lesser General Public License from time to time. Such new versions will be similar in spirit to the present version, but may differ in detail to address new problems or concerns.

Each version is given a distinguishing version number. If the Library specifies a version number of this License which applies to it and "any later version", you have the option of following the terms and conditions either of that version or of any later version published by the Free Software Foundation. If the Library does not specify a license version number, you may choose any version ever published by the Free Software Foundation.

14. If you wish to incorporate parts of the Library into other free programs whose distribution conditions are incompatible with these, write to the author to ask for permission. For software which is copyrighted by the Free Software Foundation, write to the Free Software Foundation; we sometimes make exceptions for this. Our decision will be guided by the two goals of preserving the free status of all derivatives of our free software and of promoting the sharing and reuse of software generally.

## NO WARRANTY

15. BECAUSE THE LIBRARY IS LICENSED FREE OF CHARGE, THERE IS NO WARRANTY FOR THE LIBRARY, TO THE EXTENT PERMITTED BY APPLICABLE LAW. EXCEPT WHEN OTHERWISE STATED IN WRITING THE COPYRIGHT HOLDERS AND/OR OTHER PARTIES PROVIDE THE LIBRARY "AS IS" WITHOUT WARRANTY OF ANY KIND, EITHER EXPRESSED OR IMPLIED, INCLUDING BUT NOT LIMITED TO THE IMPLIED WARRANTIES OF MERCHANTABILITY AND FITNESS FOR A PARTICULAR PURPOSE. THE ENTIRE RISK AS TO THE QUALITY AND PERFORMANCE OF THE LIBRARY IS WITH YOU. SHOULD THE LIBRARY PROVE DEFECTIVE, YOU ASSUME THE COST OF ALL NECESSARY SERVICING, REPAIR OR CORRECTION.

16. IN NO EVENT UNLESS REQUIRED BY APPLICABLE LAW OR AGREED TO IN WRITING WILL ANY COPYRIGHT HOLDER, OR ANY OTHER PARTY WHO MAY MODIFY AND/OR REDISTRIBUTE THE LIBRARY AS PERMITTED ABOVE, BE LIABLE TO YOU FOR DAMAGES, INCLUDING ANY GENERAL, SPECIAL, INCIDENTAL OR CONSEQUENTIAL DAMAGES ARISING OUT OF THE USE OR INABILITY TO USE THE LIBRARY (INCLUDING BUT NOT LIMITED TO LOSS OF DATA OR DATA BEING RENDERED INACCURATE OR LOSSES SUSTAINED BY YOU OR THIRD PARTIES OR A FAILURE OF THE LIBRARY TO OPERATE WITH ANY OTHER SOFTWARE), EVEN IF SUCH HOLDER OR OTHER PARTY HAS BEEN ADVISED OF THE POSSIBILITY OF SUCH DAMAGES.

## END OF TERMS AND CONDITIONS

### How to Apply These Terms to Your New Libraries

If you develop a new library, and you want it to be of the greatest possible use to the public, the best way to do this is to make it free software that everyone can redistribute and change. You can do so by permitting redistribution under these terms (or, alternatively, under the terms of the ordinary General Public License).

To apply these terms, attach the following notices to the library. It is safest to attach them to the start of each source file to most effectively convey the exclusion of warranty; and each file should have at least the

"copyright" line and a pointer to where the full notice is found.

<one line to give the library's name and a brief idea of what it does.>  
Copyright (C) <year> <name of author>

This library is free software; you can redistribute it and/or modify it under the terms of the GNU Lesser General Public License as published by the Free Software Foundation; either version 2.1 of the License, or (at your option) any later version.

This library is distributed in the hope that it will be useful, but WITHOUT ANY WARRANTY; without even the implied warranty of MERCHANTABILITY or FITNESS FOR A PARTICULAR PURPOSE. See the GNU Lesser General Public License for more details.

You should have received a copy of the GNU Lesser General Public License along with this library; if not, write to the Free Software Foundation, Inc., 51 Franklin Street, Fifth Floor, Boston, MA 02110-1301 USA

Also add information on how to contact you by electronic and paper mail.

You should also get your employer (if you work as a programmer) or your school, if any, to sign a "copyright disclaimer" for the library, if necessary. Here is a sample; alter the names:

Yoyodyne, Inc., hereby disclaims all copyright interest in the library 'Frob' (a library for tweaking knobs) written by James Random Hacker.

<signature of Ty Coon>, 1 April 1990  
Ty Coon, President of Vice

That's all there is to it!

Copyright (C) 2000,2001,2002,2003,2004,2005,2006,2007 Josh Coalson

Redistribution and use in source and binary forms, with or without modification, are permitted provided that the following conditions are met:

- Redistributions of source code must retain the above copyright notice, this list of conditions and the following disclaimer.
- Redistributions in binary form must reproduce the above copyright notice, this list of conditions and the following disclaimer in the documentation and/or other materials provided with the distribution.

- Neither the name of the Xiph.org Foundation nor the names of its contributors may be used to endorse or promote products derived from this software without specific prior written permission.

THIS SOFTWARE IS PROVIDED BY THE COPYRIGHT HOLDERS AND CONTRIBUTORS "AS IS" AND ANY EXPRESS OR IMPLIED WARRANTIES, INCLUDING, BUT NOT LIMITED TO, THE IMPLIED WARRANTIES OF MERCHANTABILITY AND FITNESS FOR A PARTICULAR PURPOSE ARE DISCLAIMED. IN NO EVENT SHALL THE FOUNDATION OR CONTRIBUTORS BE LIABLE FOR ANY DIRECT, INDIRECT, INCIDENTAL, SPECIAL, EXEMPLARY, OR CONSEQUENTIAL DAMAGES (INCLUDING, BUT NOT LIMITED TO, PROCUREMENT OF SUBSTITUTE GOODS OR SERVICES; LOSS OF USE, DATA, OR PROFITS; OR BUSINESS INTERRUPTION) HOWEVER CAUSED AND ON ANY THEORY OF LIABILITY, WHETHER IN CONTRACT, STRICT LIABILITY, OR TORT (INCLUDING NEGLIGENCE OR OTHERWISE) ARISING IN ANY WAY OUT OF THE USE OF THIS SOFTWARE, EVEN IF ADVISED OF THE POSSIBILITY OF SUCH DAMAGE.

## fontconfig/COPYING

Copyright © 2000,2001,2002,2003,2004,2006,2007 Keith Packard  
Copyright © 2005 Patrick Lam  
Copyright © 2009 Roozbeh Pournader  
Copyright © 2008,2009 Red Hat, Inc.  
Copyright © 2008 Danilo Šegan  
Copyright © 2012 Google, Inc.

Permission to use, copy, modify, distribute, and sell this software and its documentation for any purpose is hereby granted without fee, provided that the above copyright notice appear in all copies and that both that copyright notice and this permission notice appear in supporting documentation, and that the name of the author(s) not be used in advertising or publicity pertaining to distribution of the software without specific, written prior permission. The authors make no representations about the suitability of this software for any purpose. It is provided "as is" without express or implied warranty.

THE AUTHOR(S) DISCLAIMS ALL WARRANTIES WITH REGARD TO THIS SOFTWARE, INCLUDING ALL IMPLIED WARRANTIES OF MERCHANTABILITY AND FITNESS, IN NO EVENT SHALL THE AUTHOR(S) BE LIABLE FOR ANY SPECIAL, INDIRECT OR CONSEQUENTIAL DAMAGES OR ANY DAMAGES WHATSOEVER RESULTING FROM LOSS OF USE, DATA OR PROFITS, WHETHER IN AN ACTION OF CONTRACT, NEGLIGENCE OR OTHER TORTIOUS ACTION, ARISING OUT OF OR IN CONNECTION WITH THE USE OR PERFORMANCE OF THIS SOFTWARE.

## The FreeType Project LICENSE

2006-Jan-27

Copyright 1996-2002, 2006 by  
David Turner, Robert Wilhelm, and Werner Lemberg

## Introduction

The FreeType Project is distributed in several archive packages; some of them may contain, in addition to the FreeType font engine, various tools and contributions which rely on, or relate to, the FreeType Project.

This license applies to all files found in such packages, and which do not fall under their own explicit license. The license affects thus the FreeType font engine, the test programs, documentation and makefiles, at the very least.

This license was inspired by the BSD, Artistic, and IJG (Independent JPEG Group) licenses, which all encourage inclusion and use of free software in commercial and freeware products alike. As a consequence, its main points are that:

- o We don't promise that this software works. However, we will be interested in any kind of bug reports. ( ' as is ' distribution)
- o You can use this software for whatever you want, in parts or full form, without having to pay us. ( ' royalty-free ' usage)
- o You may not pretend that you wrote this software. If you use it, or only parts of it, in a program, you must acknowledge somewhere in your documentation that you have used the FreeType code. ( ' credits ')

We specifically permit and encourage the inclusion of this



software, with or without modifications, in commercial products. We disclaim all warranties covering The FreeType Project and assume no liability related to The FreeType Project.

Finally, many people asked us for a preferred form for a credit/disclaimer to use in compliance with this license. We thus encourage you to use the following text:

```
""
Portions of this software are copyright © <year> The FreeType
Project (www.freetype.org). All rights reserved.
""
```

Please replace <year> with the value from the FreeType version you actually use.

## Legal Terms

### 0. Definitions

Throughout this license, the terms 'package', 'FreeType Project', and 'FreeType archive' refer to the set of files originally distributed by the authors (David Turner, Robert Wilhelm, and Werner Lemberg) as the 'FreeType Project', be they named as alpha, beta or final release.

'You' refers to the licensee, or person using the project, where 'using' is a generic term including compiling the project's source code as well as linking it to form a 'program' or 'executable'. This program is referred to as 'a program using the FreeType engine'.

This license applies to all files distributed in the original FreeType Project, including all source code, binaries and documentation, unless otherwise stated in the file in its original, unmodified form as distributed in the original archive. If you are unsure whether or not a particular file is covered by this license, you must contact us to verify this.

The FreeType Project is copyright (C) 1996-2000 by David Turner, Robert Wilhelm, and Werner Lemberg. All rights reserved except as specified below.

### 1. No Warranty

THE FREETYPE PROJECT IS PROVIDED 'AS IS' WITHOUT WARRANTY OF ANY KIND, EITHER EXPRESS OR IMPLIED, INCLUDING, BUT NOT LIMITED TO, WARRANTIES OF MERCHANTABILITY AND FITNESS FOR A PARTICULAR PURPOSE. IN NO EVENT WILL ANY OF THE AUTHORS OR COPYRIGHT HOLDERS BE LIABLE FOR ANY DAMAGES CAUSED BY THE USE OR THE INABILITY TO USE, OF THE FREETYPE PROJECT.

### 2. Redistribution

This license grants a worldwide, royalty-free, perpetual and irrevocable right and license to use, execute, perform, compile, display, copy, create derivative works of, distribute and sublicense the FreeType Project (in both source and object code forms) and derivative works thereof for any purpose; and to authorize others to exercise some or all of the rights granted herein, subject to the following conditions:

- o Redistribution of source code must retain this license file (FTL.TXT) unaltered; any additions, deletions or changes to the original files must be clearly indicated in accompanying documentation. The copyright notices of the unaltered, original files must be preserved in all copies of source files.

- o Redistribution in binary form must provide a disclaimer that states that the software is based in part of the work of the FreeType Team, in the distribution documentation. We also encourage you to put an URL to the FreeType web page in your documentation, though this isn't mandatory.

These conditions apply to any software derived from or based on the FreeType Project, not just the unmodified files. If you use our work, you must acknowledge us. However, no fee need be paid to us.

### 3. Advertising

Neither the FreeType authors and contributors nor you shall use the name of the other for commercial, advertising, or promotional purposes without specific prior written permission.

We suggest, but do not require, that you use one or more of the following phrases to refer to this software in your documentation or advertising materials: 'FreeType Project', 'FreeType Engine', 'FreeType library', or 'FreeType Distribution'.

As you have not signed this license, you are not required to accept it. However, as the FreeType Project is copyrighted material, only this license, or another one contracted with the authors, grants you the right to use, distribute, and modify it. Therefore, by using, distributing, or modifying the FreeType Project, you indicate that you understand and accept all the terms of this license.

### 4. Contacts

There are two mailing lists related to FreeType:

- o freetype@nongnu.org

Discusses general use and applications of FreeType, as well as future and wanted additions to the library and distribution. If you are looking for support, start in this list. If you haven't found anything to help you in the documentation.

- o freetype-devel@nongnu.org

Discusses bugs, as well as engine internals, design issues, specific licenses, porting, etc.

Our home page can be found at

<http://www.freetype.org>

--- end of FTL.TXT ---

HarfBuzz is licensed under the so-called "Old MIT" license. Details follow. For parts of HarfBuzz that are licensed under different licenses see individual files names COPYING in subdirectories where applicable.

Copyright © 2010,2011,2012 Google, Inc.  
Copyright © 2012 Mozilla Foundation

Copyright © 2011 Codethink Limited  
Copyright © 2008,2010 Nokia Corporation and/or its subsidiary(-ies)  
Copyright © 2009 Keith Stribley  
Copyright © 2009 Martin Hosken and SIL International  
Copyright © 2007 Chris Wilson  
Copyright © 2006 Behdad Esfahbod  
Copyright © 2005 David Turner  
Copyright © 2004,2007,2008,2009,2010 Red Hat, Inc.  
Copyright © 1998-2004 David Turner and Werner Lemberg

For full copyright notices consult the individual files in the package.

Permission is hereby granted, without written agreement and without license or royalty fees, to use, copy, modify, and distribute this software and its documentation for any purpose, provided that the above copyright notice and the following two paragraphs appear in all copies of this software.

IN NO EVENT SHALL THE COPYRIGHT HOLDER BE LIABLE TO ANY PARTY FOR DIRECT, INDIRECT, SPECIAL, INCIDENTAL, OR CONSEQUENTIAL DAMAGES ARISING OUT OF THE USE OF THIS SOFTWARE AND ITS DOCUMENTATION, EVEN IF THE COPYRIGHT HOLDER HAS BEEN ADVISED OF THE POSSIBILITY OF SUCH DAMAGE.

THE COPYRIGHT HOLDER SPECIFICALLY DISCLAIMS ANY WARRANTIES, INCLUDING, BUT NOT LIMITED TO, THE IMPLIED WARRANTIES OF MERCHANTABILITY AND FITNESS FOR A PARTICULAR PURPOSE. THE SOFTWARE PROVIDED HEREUNDER IS ON AN "AS IS" BASIS, AND THE COPYRIGHT HOLDER HAS NO OBLIGATION TO PROVIDE MAINTENANCE, SUPPORT, UPDATES, ENHANCEMENTS, OR MODIFICATIONS.

## GNU LESSER GENERAL PUBLIC LICENSE

Version 2.1, February 1999

Copyright (C) 1991, 1999 Free Software Foundation, Inc.  
59 Temple Place, Suite 330, Boston, MA 02111-1307 USA  
Everyone is permitted to copy and distribute verbatim copies of this license document, but changing it is not allowed.

[This is the first released version of the Lesser GPL. It also counts as the successor of the GNU Library Public License, version 2, hence the version number 2.1.]

### Preamble

The licenses for most software are designed to take away your freedom to share and change it. By contrast, the GNU General Public Licenses are intended to guarantee your freedom to share and change free software—to make sure the software is free for all its users.

This license, the Lesser General Public License, applies to some specially designated software packages—typically libraries—of the Free Software Foundation and other authors who decide to use it. You can use it too, but we suggest you first think carefully about whether this license or the ordinary General Public License is the better strategy to use in any particular case, based on the explanations below.

When we speak of free software, we are referring to freedom of use, not price. Our General Public Licenses are designed to make sure that you have the freedom to distribute copies of free software (and charge for this service if you wish); that you receive source code or can get it if you want it; that you can change the software and use pieces of it in new free programs; and that you are informed that you can do these things.

To protect your rights, we need to make restrictions that forbid distributors to deny you these rights or to ask you to surrender these rights. These restrictions translate to certain responsibilities for you if you distribute copies of the library or if you modify it.

For example, if you distribute copies of the library, whether gratis or for a fee, you must give the recipients all the rights that we gave you. You must make sure that they, too, receive or can get the source code. If you link other code with the library, you must provide complete object files to the recipients, so that they can relink them with the library after making changes to the library and recompiling it. And you must show them these terms so they know their rights.

We protect your rights with a two-step method: (1) we copyright the library, and (2) we offer you this license, which gives you legal permission to copy, distribute and/or modify the library.

To protect each distributor, we want to make it very clear that there is no warranty for the free library. Also, if the library is modified by someone else and passed on, the recipients should know that what they have is not the original version, so that the original author's reputation will not be affected by problems that might be introduced by others.

Finally, software patents pose a constant threat to the existence of any free program. We wish to make sure that a company cannot effectively restrict the users of a free program by obtaining a restrictive license from a patent holder. Therefore, we insist that any patent license obtained for a version of the library must be consistent with the full freedom of use specified in this license.

Most GNU software, including some libraries, is covered by the ordinary GNU General Public License. This license, the GNU Lesser General Public License, applies to certain designated libraries, and is quite different from the ordinary General Public License. We use this license for certain libraries in order to permit linking those libraries into non-free programs.

When a program is linked with a library, whether statically or using a shared library, the combination of the two is legally speaking a combined work, a derivative of the original library. The ordinary General Public License therefore permits such linking only if the entire combination fits its criteria of freedom. The Lesser General Public License permits more lax criteria for linking other code with the library.

We call this license the "Lesser" General Public License because it does Less to protect the user's freedom than the ordinary General Public License. It also provides other free software developers Less of an advantage over competing non-free programs. These disadvantages are the reason we use the ordinary General Public License for some libraries. However, the Lesser license provides advantages in certain special circumstances.

For example, on rare occasions, there may be a special need to encourage the widest possible use of a certain library, so that it becomes

a de-facto standard. To achieve this, non-free programs must be allowed to use the library. A more frequent case is that a free library does the same job as widely used non-free libraries. In this case, there is little to gain by limiting the free library to free software only, so we use the Lesser General Public License.

In other cases, permission to use a particular library in non-free programs enables a greater number of people to use a large body of free software. For example, permission to use the GNU C Library in non-free programs enables many more people to use the whole GNU operating system, as well as its variant, the GNU/Linux operating system.

# 本機で使われるソフトウェアライセンス情報 (つづき)

Although the Lesser General Public License is less protective of the users' freedom, it does ensure that the user of a program that is linked with the Library has the freedom and the wherewithal to run that program using a modified version of the Library.

The precise terms and conditions for copying, distribution and modification follow. Pay close attention to the difference between a "work based on the library" and a "work that uses the library". The former contains code derived from the library, whereas the latter must be combined with the library in order to run.

## GNU LESSER GENERAL PUBLIC LICENSE TERMS AND CONDITIONS FOR COPYING, DISTRIBUTION AND MODIFICATION

0. This License Agreement applies to any software library or other program which contains a notice placed by the copyright holder or other authorized party saying it may be distributed under the terms of this Lesser General Public License (also called "this License"). Each licensee is addressed as "you".

A "library" means a collection of software functions and/or data prepared so as to be conveniently linked with application programs (which use some of those functions and data) to form executables.

The "Library", below, refers to any such software library or work which has been distributed under these terms. A "work based on the Library" means either the Library or any derivative work under copyright law: that is to say, a work containing the Library or a portion of it, either verbatim or with modifications and/or translated straightforwardly into another language. (Hereinafter, translation is included without limitation in the term "modification".)

"Source code" for a work means the preferred form of the work for making modifications to it. For a library, complete source code means all the source code for all modules it contains, plus any associated interface definition files, plus the scripts used to control compilation and installation of the library.

Activities other than copying, distribution and modification are not covered by this License; they are outside its scope. The act of running a program using the Library is not restricted, and output from such a program is covered only if its contents constitute a work based on the Library (independent of the use of the Library in a tool for writing it). Whether that is true depends on what the Library does and what the program that uses the Library does.

1. You may copy and distribute verbatim copies of the Library's complete source code as you receive it, in any medium, provided that you conspicuously and appropriately publish on each copy an appropriate copyright notice and disclaimer of warranty; keep intact all the notices that refer to this License and to the absence of any warranty; and distribute a copy of this License along with the Library.

You may charge a fee for the physical act of transferring a copy, and you may at your option offer warranty protection in exchange for a fee.

2. You may modify your copy or copies of the Library or any portion of it, thus forming a work based on the Library, and copy and distribute such modifications or work under the terms of Section 1 above, provided that you also meet all of these conditions:

- The modified work must itself be a software library.
- You must cause the files modified to carry prominent notices stating that you changed the files and the date of any change.
- You must cause the whole of the work to be licensed at no charge to all third parties under the terms of this License.
- If a facility in the modified Library refers to a function or a table of data to be supplied by an application program that uses the facility, other than as an argument passed when the facility is invoked, then you must make a good faith effort to ensure that, in the event an application does not supply such function or table, the facility still operates, and performs whatever part of its purpose remains meaningful.

(For example, a function in a library to compute square roots has a purpose that is entirely well-defined independent of the application. Therefore, Subsection 2d requires that any application-supplied function or table used by this function must be optional: if the application does not supply it, the square root function must still compute square roots.)

These requirements apply to the modified work as a whole. If identifiable sections of that work are not derived from the Library, and can be reasonably considered independent and separate works in themselves, then this License, and its terms, do not apply to those sections when you distribute them as separate works. But when you distribute the same sections as part of a whole which is a work based on the Library, the distribution of the whole must be on the terms of this License, whose permissions for other licensees extend to the entire whole, and thus to each and every part regardless of who wrote it.

Thus, it is not the intent of this section to claim rights or contest your rights to work written entirely by you; rather, the intent is to exercise the right to control the distribution of derivative or collective works based on the Library.

In addition, mere aggregation of another work not based on the Library with the Library (or with a work based on the Library) on a volume of a storage or distribution medium does not bring the other work under the scope of this License.

3. You may opt to apply the terms of the ordinary GNU General Public License instead of this License to a given copy of the Library. To do this, you must alter all the notices that refer to this License, so that they refer to the ordinary GNU General Public License, version 2, instead of to this License. (If a newer version than version 2 of the ordinary GNU General Public License has appeared, then you can specify that version instead if you wish.) Do not make any other change in these notices.

Once this change is made in a given copy, it is irreversible for that copy, so the ordinary GNU General Public License applies to all subsequent copies and derivative works made from that copy.

This option is useful when you wish to copy part of the code of the Library into a program that is not a library.

4. You may copy and distribute the Library (or a portion or derivative of it, under Section 2) in object code or executable form under the terms of Sections 1 and 2 above provided that you accompany it with the complete corresponding machine-readable source code, which must be distributed under the terms of Sections 1 and 2 above on a medium customarily used for software interchange.

If distribution of object code is made by offering access to copy from a designated place, then offering equivalent access to copy the source code from the same place satisfies the requirement to distribute the source code, even though third parties are not compelled to copy the source along with the object code.

5. A program that contains no derivative of any portion of the

Library, but is designed to work with the Library by being compiled or linked with it, is called a "work that uses the Library". Such a work, in isolation, is not a derivative work of the Library, and therefore falls outside the scope of this License.

However, linking a "work that uses the Library" with the Library creates an executable that is a derivative of the Library (because it contains portions of the Library), rather than a "work that uses the library". The executable is therefore covered by this License. Section 6 states terms for distribution of such executables.

When a "work that uses the Library" uses material from a header file that is part of the Library, the object code for the work may be a derivative work of the Library even though the source code is not. Whether this is true is especially significant if the work can be linked without the Library, or if the work is itself a library. The threshold for this to be true is not precisely defined by law.

If such an object file uses only numerical parameters, data structure layouts and accessors, and small macros and small inline functions (ten lines or less in length), then the use of the object file is unrestricted, regardless of whether it is legally a derivative work. (Executables containing this object code plus portions of the Library will still fall under Section 6.)

Otherwise, if the work is a derivative of the Library, you may distribute the object code for the work under the terms of Section 6. Any executables containing that work also fall under Section 6, whether or not they are linked directly with the Library itself.

6. As an exception to the Sections above, you may also combine or link a "work that uses the Library" with the Library to produce a work containing portions of the Library, and distribute that work under terms of your choice, provided that the terms permit modification of the work for the customer's own use and reverse engineering for debugging such modifications.

You must give prominent notice with each copy of the work that the Library is used in it and that the Library and its use are covered by this License. You must supply a copy of this License. If the work during execution displays copyright notices, you must include the copyright notice for the Library among them, as well as a reference directing the user to the copy of this License. Also, you must do one of these things:

- Accompany the work with the complete corresponding machine-readable source code for the Library including whatever changes were used in the work (which must be distributed under Sections 1 and 2 above), and, if the work is an executable linked with the Library, with the complete machine-readable "work that uses the Library", as object code and/or source code, so that the user can modify the Library and then relink to produce a modified executable containing the modified Library. (It is understood that the user who changes the contents of definitions files in the Library will not necessarily be able to recompile the application to use the modified definitions.)
- Use a suitable shared library mechanism for linking with the Library. A suitable mechanism is one that (1) uses at run time a copy of the library already present on the user's computer system, rather than copying library functions into the executable, and (2) will operate properly with a modified version of the library, if the user installs one, as long as the modified version is interface-compatible with the version that the work was made with.
- Accompany the work with a written offer, valid for at least three years, to give the same user the materials specified in Subsection 6a, above, for a charge no more than the cost of performing this distribution.
- If distribution of the work is made by offering access to copy from a designated place, offer equivalent access to copy the above specified materials from the same place.
- Verify that the user has already received a copy of these materials or that you have already sent this user a copy.

For an executable, the required form of the "work that uses the Library" must include any data and utility programs needed for reproducing the executable from it. However, as a special exception, the materials to be distributed need not include anything that is normally distributed (in either source or binary form) with the major components (compiler, kernel, and so on) of the operating system on which the executable runs, unless that component itself accompanies the executable.

It may happen that this requirement contradicts the license restrictions of other proprietary libraries that do not normally accompany the operating system. Such a contradiction means you cannot use both them and the Library together in an executable that you distribute.

7. You may place library facilities that are a work based on the Library side-by-side in a single library together with other library facilities, and distribute such a combined library, provided that the separate distribution of the work based on the Library and of the other library facilities is otherwise permitted, and provided that you do these two things:

- Accompany the combined library with a copy of the same work based on the Library, uncombined with any other library facilities. This must be distributed under the terms of the Sections above.
  - Give prominent notice with the combined library of the fact that part of it is a work based on the Library, and explaining where to find the accompanying uncombined form of the same work.
8. You may not copy, modify, sublicense, link with, or distribute the Library except as expressly provided under this License. Any attempt otherwise to copy, modify, sublicense, link with, or distribute the Library is void, and will automatically terminate your rights under this License. However, parties who have received copies, or rights, from you under this License will not have their licenses terminated so long as such parties remain in full compliance.

9. You are not required to accept this License, since you have not signed it. However, nothing else grants you permission to modify or distribute the Library or its derivative works. These actions are prohibited by law if you do not accept this License. Therefore, by modifying or distributing the Library (or any work based on the Library), you indicate your acceptance of this License to do so, and all its terms and conditions for copying, distributing or modifying the Library or works based on it.

10. Each time you redistribute the Library (or any work based on the Library), the recipient automatically receives a license from the original licensor to copy, distribute, link with or modify the Library subject to these terms and conditions. You may not impose any further restrictions on the recipients' exercise of the rights granted herein. You are not responsible for enforcing compliance by third parties with this License.

11. If, as a consequence of a court judgment or allegation of patent infringement or for any other reason (not limited to patent issues), conditions are imposed on you (whether by court order, agreement or otherwise) that contradict the conditions of this License, they do not excuse you from the conditions of this License. If you cannot distribute so as to satisfy simultaneously your obligations under this

License and any other pertinent obligations, then as a consequence you may not distribute the Library at all. For example, if a patent license would not permit royalty-free redistribution of the Library by all those who receive copies directly or indirectly through you, then the only way you could satisfy both it and this License would be to refrain entirely from distribution of the Library.

If any portion of this section is held invalid or unenforceable under any particular circumstance, the balance of the section is intended to apply, and the section as a whole is intended to apply in other circumstances.

It is not the purpose of this section to induce you to infringe any patents or other property right claims or to contest validity of any such claims; this section has the sole purpose of protecting the integrity of the free software distribution system which is implemented by public license practices. Many people have made generous contributions to the wide range of software distributed through that system in reliance on consistent application of that system; it is up to the author/donor to decide if he or she is willing to distribute software through any other system and a licensee cannot impose that choice.

This section is intended to make thoroughly clear what is believed to be a consequence of the rest of this License.

12. If the distribution and/or use of the Library is restricted in certain countries either by patents or by copyrighted interfaces, the original copyright holder who places the Library under this License may add an explicit geographical distribution limitation excluding those countries, so that distribution is permitted only in or among countries not thus excluded. In such case, this License incorporates the limitation as if written in the body of this License.

13. The Free Software Foundation may publish revised and/or new versions of the Lesser General Public License from time to time. Such new versions will be similar in spirit to the present version, but may differ in detail to address new problems or concerns.

Each version is given a distinguishing version number. If the Library specifies a version number of this License which applies to it and "any later version", you have the option of following the terms and conditions either of that version or of any later version published by the Free Software Foundation. If the Library does not specify a license version number, you may choose any version ever published by the Free Software Foundation.

14. If you wish to incorporate parts of the Library into other free programs whose distribution conditions are incompatible with these, write to the author to ask for permission. For software which is copyrighted by the Free Software Foundation, write to the Free Software Foundation; we sometimes make exceptions for this. Our decision will be guided by the two goals of preserving the free status of all derivatives of our free software and of promoting the sharing and reuse of software generally.

NO WARRANTY

15. BECAUSE THE LIBRARY IS LICENSED FREE OF CHARGE, THERE IS NO WARRANTY FOR THE LIBRARY TO THE EXTENT PERMITTED BY APPLICABLE LAW. EXCEPT WHEN OTHERWISE STATED IN WRITING THE COPYRIGHT HOLDERS AND/OR OTHER PARTIES PROVIDE THE LIBRARY "AS IS" WITHOUT WARRANTY OF ANY KIND, EITHER EXPRESSED OR IMPLIED, INCLUDING, BUT NOT LIMITED TO, THE IMPLIED WARRANTIES OF MERCHANTABILITY AND FITNESS FOR A PARTICULAR PURPOSE. THE ENTIRE RISK AS TO THE QUALITY AND PERFORMANCE OF THE LIBRARY IS WITH YOU. SHOULD THE LIBRARY PROVE DEFECTIVE, YOU ASSUME THE COST OF ALL NECESSARY SERVICING, REPAIR OR CORRECTION.

16. IN NO EVENT UNLESS REQUIRED BY APPLICABLE LAW OR AGREED TO IN WRITING WILL ANY COPYRIGHT HOLDER, OR ANY OTHER PARTY WHO MAY MODIFY AND/OR REDISTRIBUTE THE LIBRARY AS PERMITTED ABOVE, BE LIABLE TO YOU FOR DAMAGES, INCLUDING ANY GENERAL, SPECIAL, INCIDENTAL OR CONSEQUENTIAL DAMAGES ARISING OUT OF THE USE OR INABILITY TO USE THE LIBRARY (INCLUDING BUT NOT LIMITED TO LOSS OF DATA OR DATA BEING RENDERED INACCURATE OR LOSSES SUSTAINED BY YOU OR THIRD PARTIES OR A FAILURE OF THE LIBRARY TO OPERATE WITH ANY OTHER SOFTWARE), EVEN IF SUCH HOLDER OR OTHER PARTY HAS BEEN ADVISED OF THE POSSIBILITY OF SUCH DAMAGES.

END OF TERMS AND CONDITIONS

How to Apply These Terms to Your New Libraries

If you develop a new library, and you want it to be of the greatest possible use to the public, we recommend making it free software that everyone can redistribute and change. You can do so by permitting redistribution under these terms (or, alternatively, under the terms of the ordinary General Public License).

To apply these terms, attach the following notices to the library. It is safest to attach them to the start of each source file to most effectively convey the exclusion of warranty; and each file should have at least the "copyright" line and a pointer to where the full notice is found.

<one line to give the library's name and a brief idea of what it does.>  
Copyright (C) <year> <name of author>

This library is free software: you can redistribute it and/or modify it under the terms of the GNU Lesser General Public License as published by the Free Software Foundation; either version 2 of the License, or (at your option) any later version.

This library is distributed in the hope that it will be useful, but WITHOUT ANY WARRANTY; without even the implied warranty of MERCHANTABILITY or FITNESS FOR A PARTICULAR PURPOSE. See the GNU Lesser General Public License for more details.

You should have received a copy of the GNU Lesser General Public License along with this library; if not, write to the Free Software Foundation, Inc., 59 Temple Place, Suite 330, Boston, MA 02111-1307 USA

Also add information on how to contact you by electronic and paper mail.

You should also get your employer (if you work as a programmer) or your school, if any, to sign a "copyright disclaimer" for the library, if necessary. Here is a sample; alter the names:

Yoyodyne, Inc., hereby disclaims all copyright interest in the library 'Frob' (a library for tweaking knobs) written by James Random Hacker.

<signature of Ty Coon>, 1 April 1990  
Ty Coon, President of Vice

That's all there is to it!

LICENSE extracted from IJG's jpeg distribution:

In plain English:

- 1. We don't promise that this software works. (But if you find any bugs, please let us know!)
- 2. You can use this software for whatever you want. You don't have to pay us.
- 3. You may not pretend that you wrote this software. If you use it in a program, you must acknowledge somewhere in your documentation that you've used the IJG code.

In legalese:

The authors make NO WARRANTY or representation, either express or implied, with respect to this software, its quality, accuracy, merchantability, or fitness for a particular purpose. This software is provided "AS IS", and you, its user, assume the entire risk as to its quality and accuracy.

This software is copyright (C) 1991-1998, Thomas G. Lane. All Rights Reserved except as specified below.

Permission is hereby granted to use, copy, modify, and distribute this software (or portions thereof) for any purpose, without fee, subject to these conditions:

- (1) If any part of the source code for this software is distributed, then this README file must be included, with this copyright and no-warranty notice unaltered; and any additions, deletions, or changes to the original files must be clearly indicated in accompanying documentation.
- (2) If only executable code is distributed, then the accompanying documentation must state that "this software is based in part on the work of the Independent JPEG Group".
- (3) Permission for use of this software is granted only if the user accepts full responsibility for any undesirable consequences; the authors accept NO LIABILITY for damages of any kind.

These conditions apply to any software derived from or based on the IJG code, not just to the unmodified library. If you use our work, you ought to acknowledge us.

Permission is NOT granted for the use of any IJG author's name or company name in advertising or publicity relating to this software or products derived from it. This software may be referred to only as "the Independent JPEG Group's software".

We specifically permit and encourage the use of this software as the basis of commercial products, provided that all warranty or liability claims are assumed by the product vendor.

ICU License - ICU 1.8.1 and later

COPYRIGHT AND PERMISSION NOTICE

Copyright (c) 1995-2015 International Business Machines Corporation and others

All rights reserved.

Permission is hereby granted, free of charge, to any person obtaining a copy of this software and associated documentation files (the "Software"), to deal in the Software without restriction, including without limitation the rights to use, copy, modify, merge, publish, distribute, and/or sell copies of the Software, and to permit persons to whom the Software is furnished to do so, provided that the above copyright notice(s) and this permission notice appear in all copies of the Software and that both the above copyright notice(s) and this permission notice appear in supporting documentation.

THE SOFTWARE IS PROVIDED "AS IS", WITHOUT WARRANTY OF ANY KIND, EXPRESS OR IMPLIED, INCLUDING BUT NOT LIMITED TO THE WARRANTIES OF MERCHANTABILITY, FITNESS FOR A PARTICULAR PURPOSE AND NONINFRINGEMENT OF THIRD PARTY RIGHTS. IN NO EVENT SHALL THE COPYRIGHT HOLDER OR HOLDERS INCLUDED IN THIS NOTICE BE LIABLE FOR ANY CLAIM, OR ANY SPECIAL INDIRECT OR CONSEQUENTIAL DAMAGES, OR ANY DAMAGES WHATSOEVER RESULTING FROM LOSS OF USE, DATA OR PROFITS, WHETHER IN AN ACTION OF CONTRACT, NEGLIGENCE OR OTHER TORTIOUS ACTION, ARISING OUT OF OR IN CONNECTION WITH THE USE OR PERFORMANCE OF THIS SOFTWARE.

Except as contained in this notice, the name of a copyright holder shall not be used in advertising or otherwise to promote the sale, use or other dealings in this Software without prior written authorization of the copyright holder.

All trademarks and registered trademarks mentioned herein are the property of their respective owners.

Third-Party Software Licenses

This section contains third-party software notices and/or additional terms for licensed third-party software components included within ICU libraries.

1. Unicode Data Files and Software

COPYRIGHT AND PERMISSION NOTICE

Copyright © 1991-2015 Unicode, Inc. All rights reserved. Distributed under the Terms of Use in http://www.unicode.org/copyright.html.

Permission is hereby granted, free of charge, to any person obtaining a copy of the Unicode data files and any associated documentation (the "Data Files") or Unicode software and any associated documentation (the "Software") to deal in the Data Files or Software without restriction, including without limitation the rights to use, copy, modify, merge, publish, distribute, and/or sell copies of the Data Files or Software, and to permit persons to whom the Data Files or Software are furnished to do so, provided that (a) this copyright and permission notice appear with all copies of the Data Files or Software, (b) this copyright and permission notice appear in associated documentation, and (c) there is clear notice in each modified Data File or in the Software as well as in the documentation associated with the Data File(s) or Software that the data or software has been modified.

THE DATA FILES AND SOFTWARE ARE PROVIDED "AS IS", WITHOUT WARRANTY OF ANY KIND, EXPRESS OR IMPLIED, INCLUDING BUT NOT LIMITED TO THE WARRANTIES OF MERCHANTABILITY, FITNESS FOR A PARTICULAR PURPOSE AND NONINFRINGEMENT OF THIRD PARTY RIGHTS. IN NO EVENT SHALL THE COPYRIGHT HOLDER OR HOLDERS INCLUDED IN THIS NOTICE BE LIABLE FOR ANY CLAIM, OR ANY SPECIAL INDIRECT OR CONSEQUENTIAL DAMAGES, OR ANY DAMAGES WHATSOEVER RESULTING FROM LOSS OF USE, DATA OR PROFITS, WHETHER IN AN ACTION OF CONTRACT, NEGLIGENCE OR OTHER TORTIOUS ACTION, ARISING OUT OF OR IN CONNECTION WITH THE USE OR PERFORMANCE OF THE DATA FILES OR SOFTWARE.

Except as contained in this notice, the name of a copyright holder shall not be used in advertising or otherwise to promote the sale, use or other dealings in these Data Files or Software without prior written authorization of the copyright holder.

2. Chinese/Japanese Word Break Dictionary Data (cjdict.txt)

- # The Google Chrome software developed by Google is licensed under the BSD license. Other software included in this distribution is provided under other licenses, as set forth below.
- #
- # The BSD License

# 本機で使われるソフトウェアライセンス情報 (つづき)

```

# http://opensource.org/licenses/bsd-license.php
# Copyright (C) 2006-2008, Google Inc.
#
# All rights reserved.
#
# Redistribution and use in source and binary forms, with or
# without modification, are permitted provided that the
# following conditions are met:
#
# Redistributions of source code must retain the above copyright
# notice, this list of conditions and the following disclaimer.
# Redistributions in binary form must reproduce the above
# copyright notice, this list of conditions and the following
# disclaimer in the documentation and/or other materials
# provided with the distribution.
# Neither the name of Google Inc. nor the names of its
# contributors may be used to endorse or promote products
# derived from this software without specific prior written
# permission.
#
#
# THIS SOFTWARE IS PROVIDED BY THE COPYRIGHT HOLDERS AND
# CONTRIBUTORS "AS IS" AND ANY EXPRESS OR IMPLIED WARRANTIES,
# INCLUDING, BUT NOT LIMITED TO, THE IMPLIED WARRANTIES OF
# MERCHANTABILITY AND FITNESS FOR A PARTICULAR PURPOSE ARE
# DISCLAIMED. IN NO EVENT SHALL THE COPYRIGHT OWNER OR
# CONTRIBUTORS BE LIABLE FOR ANY DIRECT, INDIRECT, INCIDENTAL,
# SPECIAL, EXEMPLARY, OR CONSEQUENTIAL DAMAGES (INCLUDING, BUT
# NOT LIMITED TO, PROCUREMENT OF SUBSTITUTE GOODS OR SERVICES;
# LOSS OF USE, DATA, OR PROFITS; OR BUSINESS INTERRUPTION)
# HOWEVER CAUSED AND ON ANY THEORY OF LIABILITY, WHETHER IN
# CONTRACT, STRICT LIABILITY, OR TORT (INCLUDING NEGLIGENCE OR
# OTHERWISE) ARISING IN ANY WAY OUT OF THE USE OF THIS SOFTWARE,
# EVEN IF ADVISED OF THE POSSIBILITY OF SUCH DAMAGE.
#
#
# The word list in cjdict.txt are generated by combining three
# word lists listed below with further processing for compound
# word breaking. The frequency is generated with an iterative
# training against Google web corpora.
#
# * Ljtabe (Chinese)
#   - https://sourceforge.net/project/?group_id=1519
#   - Its license terms and conditions are shown below.
#
# * IPADIC (Japanese)
#   - http://chasen.aist-nara.ac.jp/chasen/distribution.html
#   - Its license terms and conditions are shown below.
#
# -----COPYING.libtabe-----BEGIN-----
#
# /*
# * Copyright (c) 1999 TaBE Project.
# * Copyright (c) 1999 Pai-Hsiang Hsiao.
# * All rights reserved.
# *
# * Redistribution and use in source and binary forms, with or without
# * modification, are permitted provided that the following conditions
# * are met:
# *
# * Redistributions of source code must retain the above copyright
# * notice, this list of conditions and the following disclaimer.
# * Redistributions in binary form must reproduce the above copyright
# * notice, this list of conditions and the following disclaimer in
# * the documentation and/or other materials provided with the
# * distribution.
# * Neither the name of the TaBE Project nor the names of its
# * contributors may be used to endorse or promote products derived
# * from this software without specific prior written permission.
# *
# * THIS SOFTWARE IS PROVIDED BY THE COPYRIGHT HOLDERS AND CONTRIBUTORS
# * "AS IS" AND ANY EXPRESS OR IMPLIED WARRANTIES, INCLUDING, BUT NOT
# * LIMITED TO, THE IMPLIED WARRANTIES OF MERCHANTABILITY AND FITNESS
# * FOR A PARTICULAR PURPOSE ARE DISCLAIMED. IN NO EVENT SHALL THE
# * REGENTS OR CONTRIBUTORS BE LIABLE FOR ANY DIRECT, INDIRECT,
# * INCIDENTAL, SPECIAL, EXEMPLARY, OR CONSEQUENTIAL DAMAGES
# * (INCLUDING, BUT NOT LIMITED TO, PROCUREMENT OF SUBSTITUTE GOODS OR
# * SERVICES; LOSS OF USE, DATA, OR PROFITS; OR BUSINESS INTERRUPTION)
# * HOWEVER CAUSED AND ON ANY THEORY OF LIABILITY, WHETHER IN CONTRACT,
# * STRICT LIABILITY, OR TORT (INCLUDING NEGLIGENCE OR OTHERWISE)
# * ARISING IN ANY WAY OUT OF THE USE OF THIS SOFTWARE, EVEN IF ADVISED
# * OF THE POSSIBILITY OF SUCH DAMAGE.
# */
#
# /*
# * Copyright (c) 1999 Computer Systems and Communication Lab,
# * Institute of Information Science, Academia Sinica.
# * All rights reserved.
# *
# * Redistribution and use in source and binary forms, with or without
# * modification, are permitted provided that the following conditions
# * are met:
# *
# * Redistributions of source code must retain the above copyright
# * notice, this list of conditions and the following disclaimer.
# * Redistributions in binary form must reproduce the above copyright
# * notice, this list of conditions and the following disclaimer in
# * the documentation and/or other materials provided with the
# * distribution.
# * Neither the name of the Computer Systems and Communication Lab
# * nor the names of its contributors may be used to endorse or
# * promote products derived from this software without specific
# * prior written permission.
# *
# * THIS SOFTWARE IS PROVIDED BY THE COPYRIGHT HOLDERS AND CONTRIBUTORS
# * "AS IS" AND ANY EXPRESS OR IMPLIED WARRANTIES, INCLUDING, BUT NOT
# * LIMITED TO, THE IMPLIED WARRANTIES OF MERCHANTABILITY AND FITNESS
# * FOR A PARTICULAR PURPOSE ARE DISCLAIMED. IN NO EVENT SHALL THE
# * REGENTS OR CONTRIBUTORS BE LIABLE FOR ANY DIRECT, INDIRECT,
# * INCIDENTAL, SPECIAL, EXEMPLARY, OR CONSEQUENTIAL DAMAGES
# * (INCLUDING, BUT NOT LIMITED TO, PROCUREMENT OF SUBSTITUTE GOODS OR
# * SERVICES; LOSS OF USE, DATA, OR PROFITS; OR BUSINESS INTERRUPTION)
# * HOWEVER CAUSED AND ON ANY THEORY OF LIABILITY, WHETHER IN CONTRACT,
# * STRICT LIABILITY, OR TORT (INCLUDING NEGLIGENCE OR OTHERWISE)
# * ARISING IN ANY WAY OUT OF THE USE OF THIS SOFTWARE, EVEN IF ADVISED
# * OF THE POSSIBILITY OF SUCH DAMAGE.
# */
#
# Copyright 1996 Chih-Hao Tsai @ Beckman Institute, University of Illinois
# c-tsai4@uiuc.edu http://casper.beckman.uiuc.edu/~c-tsai4
#
# -----COPYING.libtabe-----END-----
#
# -----COPYING.ipadic-----BEGIN-----
#
# Copyright 2000, 2001, 2002, 2003 Nara Institute of Science
# and Technology. All Rights Reserved.
#
# Use, reproduction, and distribution of this software is permitted.
# Any copy of this software, whether in its original form or modified,
# must include both the above copyright notice and the following
# paragraphs.
#
# Nara Institute of Science and Technology (NAIST),
# the copyright holders, disclaims all warranties with regard to this

```

```

# software, including all implied warranties of merchantability and
# fitness, in no event shall NAIST be liable for
# any special, indirect or consequential damages or any damages
# whatsoever resulting from loss of use, data or profits, whether in an
# action of contract, negligence or other tortious action, arising out
# of or in connection with the use or performance of this software.
#
# A large portion of the dictionary entries
# originate from ICOT Free Software. The following conditions for ICOT
# Free Software applies to the current dictionary as well.
#
# Each User may also freely distribute the Program, whether in its
# original form or modified, to any third party or parties, PROVIDED
# that the provisions of Section 3 ("NO WARRANTY") will ALWAYS appear
# on, or be attached to, the Program, which is distributed substantially
# in the same form as set out herein and that such intended
# distribution, if actually made, will neither violate or otherwise
# contravene any of the laws and regulations of the countries having
# jurisdiction over the User or the intended distribution itself.
#
# NO WARRANTY
#
# The program was produced on an experimental basis in the course of the
# research and development conducted during the project and is provided
# to users as so produced on an experimental basis. Accordingly, the
# program is provided without any warranty whatsoever, whether express,
# implied, statutory or otherwise. The term "warranty" used herein
# includes, but is not limited to, any warranty of the quality,
# performance, merchantability and fitness for a particular purpose of
# the program and the nonexistence of any infringement or violation of
# any right of any third party.
#
# Each user of the program will agree and understand, and be deemed to
# have agreed and understood, that there is no warranty whatsoever for
# the program and, accordingly, the entire risk arising from or
# otherwise connected with the program is assumed by the user.
#
# Therefore, neither ICOT, the copyright holder, or any other
# organization that participated in or was otherwise related to the
# development of the program and their respective officials, directors,
# officers and other employees shall be held liable for any and all
# damages, including, without limitation, general, special, incidental
# and consequential damages, arising out of or otherwise in connection
# with the use or inability to use the program or any product, material
# or result produced or otherwise obtained by using the program,
# regardless of whether they have been advised of, or otherwise had
# knowledge of, the possibility of such damages at any time during the
# project of thereafter. Each user will be deemed to have agreed to the
# foregoing by his or her commencement of use of the program. The term
# "use" as used herein includes, but is not limited to, the use,
# modification, copying and distribution of the program and the
# production of secondary products from the program.
#
# In the case where the program, whether in its original form or
# modified, was distributed or delivered to or received by a user from
# any person, organization or entity other than ICOT, unless it makes or
# grants independently of ICOT any specific warranty to the user in
# writing, such person, organization or entity, will also be exempted
# from and not be held liable to the user for any such damages as noted
# above as far as the program is concerned.
#
# -----COPYING.ipadic-----END-----
#
# 3. Lao Word Break Dictionary Data (laodict.txt)
#
# Copyright (c) 2013 International Business Machines Corporation
# and others. All Rights Reserved.
#
# Project: http://code.google.com/p/lao-dictionary/
# Dictionary: http://lao-dictionary.googlecode.com/git/Lao-Dictionary.txt
# License: http://lao-dictionary.googlecode.com/git/Lao-Dictionary-LICENSE.txt
# (copied below)
#
# This file is derived from the above dictionary, with slight modifications.
#
# Copyright (C) 2013 Brian Eugene Wilson, Robert Martin Campbell.
# All rights reserved.
#
# Redistribution and use in source and binary forms, with or without modification,
# are permitted provided that the following conditions are met:
#
# Redistributions of source code must retain the above copyright notice, this
# list of conditions and the following disclaimer. Redistributions in binary
# form must reproduce the above copyright notice, this list of conditions and
# the following disclaimer in the documentation and/or other materials
# provided with the distribution.
#
# THIS SOFTWARE IS PROVIDED BY THE COPYRIGHT HOLDERS AND CONTRIBUTORS "AS IS" AND
# ANY EXPRESS OR IMPLIED WARRANTIES, INCLUDING, BUT NOT LIMITED TO, THE IMPLIED
# WARRANTIES OF MERCHANTABILITY AND FITNESS FOR A PARTICULAR PURPOSE ARE
# DISCLAIMED. IN NO EVENT SHALL THE COPYRIGHT HOLDER OR CONTRIBUTORS BE LIABLE FOR
# ANY DIRECT, INDIRECT, INCIDENTAL, SPECIAL, EXEMPLARY, OR CONSEQUENTIAL DAMAGES
# (INCLUDING, BUT NOT LIMITED TO, PROCUREMENT OF SUBSTITUTE GOODS OR SERVICES;
# LOSS OF USE, DATA, OR PROFITS; OR BUSINESS INTERRUPTION) HOWEVER CAUSED AND ON
# ANY THEORY OF LIABILITY, WHETHER IN CONTRACT, STRICT LIABILITY, OR TORT
# (INCLUDING NEGLIGENCE OR OTHERWISE) ARISING IN ANY WAY OUT OF THE USE OF THIS
# SOFTWARE, EVEN IF ADVISED OF THE POSSIBILITY OF SUCH DAMAGE.
#
# -----
#
# 4. Burmese Word Break Dictionary Data (burmesedict.txt)
#
# Copyright (c) 2014 International Business Machines Corporation
# and others. All Rights Reserved.
#
# This list is part of a project hosted at:
# github.com/kanyawttech/myanmar-karen-word-lists
#
# -----
#
# Copyright (c) 2013, LeRoy Benjamin Sharon
# All rights reserved.
#
# Redistribution and use in source and binary forms, with or without modification,
# are permitted provided that the following conditions are met:
#
# Redistributions of source code must retain the above copyright notice, this
# list of conditions and the following disclaimer.
#
# Redistributions in binary form must reproduce the above copyright notice, this
# list of conditions and the following disclaimer in the documentation n d/or
# other materials provided with the distribution.
#
# Neither the name Myanmar Karen Word Lists, nor the names of its
# contributors may be used to endorse or promote products derived from
# this software without specific prior written permission.
#
# THIS SOFTWARE IS PROVIDED BY THE COPYRIGHT HOLDERS AND CONTRIBUTORS "AS IS" AND
# ANY EXPRESS OR IMPLIED WARRANTIES, INCLUDING, BUT NOT LIMITED TO, THE IMPLIED
# WARRANTIES OF MERCHANTABILITY AND FITNESS FOR A PARTICULAR PURPOSE ARE
# DISCLAIMED. IN NO EVENT SHALL THE COPYRIGHT HOLDER OR CONTRIBUTORS BE LIABLE FOR
# ANY DIRECT, INDIRECT, INCIDENTAL, SPECIAL, EXEMPLARY, OR CONSEQUENTIAL DAMAGES
# (INCLUDING, BUT NOT LIMITED TO, PROCUREMENT OF SUBSTITUTE GOODS OR

```

SERVICES;  
# LOSS OF USE, DATA, OR PROFITS; OR BUSINESS INTERRUPTION) HOWEVER CAUSED AND ON  
# ANY THEORY OF LIABILITY, WHETHER IN CONTRACT, STRICT LIABILITY, OR TORT  
# (INCLUDING NEGLIGENCE OR OTHERWISE) ARISING IN ANY WAY OUT OF THE USE OF THIS  
# SOFTWARE, EVEN IF ADVISED OF THE POSSIBILITY OF SUCH DAMAGE.  
#

#### 5. Time Zone Database

ICU uses the public domain data and code derived from Time Zone Database for its time zone support. The ownership of the TZ database is explained in BCP 175: Procedure for Maintaining the Time Zone Database section 7.

#### 7. Database Ownership

The TZ database itself is not an IETF Contribution or an IETF document. Rather it is a pre-existing and regularly updated work that is in the public domain, and is intended to remain in the public domain. Therefore, BCPs 78 [RFC5378] and 79 [RFC3979] do not apply to the TZ Database or contributions that individuals make to it. Should any claims be made and substantiated against the TZ Database, the organization that is providing the IANA Considerations defined in this RFC, under the memorandum of understanding with the IETF, currently ICANN, may act in accordance with all competent court orders. No ownership claims will be made by ICANN or the IETF Trust on the database or the code. Any person making a contribution to the database or code waives all rights to future claims in that contribution or in the TZ Database.

Copyright (c) 2013, Google Inc.  
All rights reserved.

Redistribution and use in source and binary forms, with or without modification, are permitted provided that the following conditions are met:

- \* Redistributions of source code must retain the above copyright notice, this list of conditions and the following disclaimer.
- \* Redistributions in binary form must reproduce the above copyright notice, this list of conditions and the following disclaimer in the documentation and/or other materials provided with the distribution.
- \* The name of the author may not be used to endorse or promote products derived from this software without specific prior written permission.

THIS SOFTWARE IS PROVIDED BY THE COPYRIGHT HOLDERS AND CONTRIBUTORS "AS IS" AND ANY EXPRESS OR IMPLIED WARRANTIES, INCLUDING, BUT NOT LIMITED TO, THE IMPLIED WARRANTIES OF MERCHANTABILITY AND FITNESS FOR A PARTICULAR PURPOSE ARE DISCLAIMED. IN NO EVENT SHALL THE COPYRIGHT OWNER OR CONTRIBUTORS BE LIABLE FOR ANY DIRECT, INDIRECT, INCIDENTAL, SPECIAL, EXEMPLARY, OR CONSEQUENTIAL DAMAGES (INCLUDING, BUT NOT LIMITED TO, PROCUREMENT OF SUBSTITUTE GOODS OR SERVICES; LOSS OF USE, DATA, OR PROFITS; OR BUSINESS INTERRUPTION) HOWEVER CAUSED AND ON ANY THEORY OF LIABILITY, WHETHER IN CONTRACT, STRICT LIABILITY, OR TORT (INCLUDING NEGLIGENCE OR OTHERWISE) ARISING IN ANY WAY OUT OF THE USE OF THIS SOFTWARE, EVEN IF ADVISED OF THE POSSIBILITY OF SUCH DAMAGE.

libjpeg-turbo is licensed under a non-restrictive, BSD-style license (see README). The TurboJPEG/OSS wrapper (both C and Java versions) and associated test programs bear a similar license, which is reproduced below:

Redistribution and use in source and binary forms, with or without modification, are permitted provided that the following conditions are met:

- Redistributions of source code must retain the above copyright notice, this list of conditions and the following disclaimer.
- Redistributions in binary form must reproduce the above copyright notice, this list of conditions and the following disclaimer in the documentation and/or other materials provided with the distribution.
- Neither the name of the libjpeg-turbo Project nor the names of its contributors may be used to endorse or promote products derived from this software without specific prior written permission.

THIS SOFTWARE IS PROVIDED BY THE COPYRIGHT HOLDERS AND CONTRIBUTORS "AS IS", AND ANY EXPRESS OR IMPLIED WARRANTIES, INCLUDING, BUT NOT LIMITED TO, THE IMPLIED WARRANTIES OF MERCHANTABILITY AND FITNESS FOR A PARTICULAR PURPOSE ARE DISCLAIMED. IN NO EVENT SHALL THE COPYRIGHT HOLDERS OR CONTRIBUTORS BE LIABLE FOR ANY DIRECT, INDIRECT, INCIDENTAL, SPECIAL, EXEMPLARY, OR CONSEQUENTIAL DAMAGES (INCLUDING, BUT NOT LIMITED TO, PROCUREMENT OF SUBSTITUTE GOODS OR SERVICES; LOSS OF USE, DATA, OR PROFITS; OR BUSINESS INTERRUPTION) HOWEVER CAUSED AND ON ANY THEORY OF LIABILITY, WHETHER IN CONTRACT, STRICT LIABILITY, OR TORT (INCLUDING NEGLIGENCE OR OTHERWISE) ARISING IN ANY WAY OUT OF THE USE OF THIS SOFTWARE, EVEN IF ADVISED OF THE POSSIBILITY OF SUCH DAMAGE.

Copyright (c) 2011 The LevelDB Authors. All rights reserved.

Redistribution and use in source and binary forms, with or without modification, are permitted provided that the following conditions are met:

- \* Redistributions of source code must retain the above copyright notice, this list of conditions and the following disclaimer.
- \* Redistributions in binary form must reproduce the above copyright notice, this list of conditions and the following disclaimer in the documentation and/or other materials provided with the distribution.
- \* Neither the name of Google Inc. nor the names of its contributors may be used to endorse or promote products derived from this software without specific prior written permission.

THIS SOFTWARE IS PROVIDED BY THE COPYRIGHT HOLDERS AND CONTRIBUTORS "AS IS" AND ANY EXPRESS OR IMPLIED WARRANTIES, INCLUDING, BUT NOT LIMITED TO, THE IMPLIED WARRANTIES OF MERCHANTABILITY AND FITNESS FOR A PARTICULAR PURPOSE ARE DISCLAIMED. IN NO EVENT SHALL THE COPYRIGHT OWNER OR CONTRIBUTORS BE LIABLE FOR ANY DIRECT, INDIRECT, INCIDENTAL, SPECIAL, EXEMPLARY, OR CONSEQUENTIAL DAMAGES (INCLUDING, BUT NOT LIMITED TO, PROCUREMENT OF SUBSTITUTE GOODS OR SERVICES; LOSS OF USE, DATA, OR PROFITS; OR BUSINESS INTERRUPTION) HOWEVER CAUSED AND ON ANY THEORY OF LIABILITY, WHETHER IN CONTRACT, STRICT LIABILITY, OR TORT (INCLUDING NEGLIGENCE OR OTHERWISE) ARISING IN ANY WAY OUT OF THE USE OF THIS SOFTWARE, EVEN IF ADVISED OF THE POSSIBILITY OF SUCH DAMAGE.

LZMA SDK is placed in the public domain.

A C-program for MT19937, with initialization improved 2002/1/26.  
Coded by Takuji Nishimura and Makoto Matsumoto.

Before using, initialize the state by using `init_genrand(seed)` or `init_by_array(init_key, key_length)`.

Copyright (C) 1997 - 2002, Makoto Matsumoto and Takuji Nishimura,  
All rights reserved.

Redistribution and use in source and binary forms, with or without modification, are permitted provided that the following conditions are met:

1. Redistributions of source code must retain the above copyright notice, this list of conditions and the following disclaimer.
2. Redistributions in binary form must reproduce the above copyright notice, this list of conditions and the following disclaimer in the documentation and/or other materials provided with the distribution.
3. The names of its contributors may not be used to endorse or promote products derived from this software without specific prior written permission.

THIS SOFTWARE IS PROVIDED BY THE COPYRIGHT HOLDERS AND CONTRIBUTORS "AS IS" AND ANY EXPRESS OR IMPLIED WARRANTIES, INCLUDING, BUT NOT LIMITED TO, THE IMPLIED WARRANTIES OF MERCHANTABILITY AND FITNESS FOR A PARTICULAR PURPOSE ARE DISCLAIMED. IN NO EVENT SHALL THE COPYRIGHT OWNER OR CONTRIBUTORS BE LIABLE FOR ANY DIRECT, INDIRECT, INCIDENTAL, SPECIAL, EXEMPLARY, OR CONSEQUENTIAL DAMAGES (INCLUDING, BUT NOT LIMITED TO, PROCUREMENT OF SUBSTITUTE GOODS OR SERVICES; LOSS OF USE, DATA, OR PROFITS; OR BUSINESS INTERRUPTION) HOWEVER CAUSED AND ON ANY THEORY OF LIABILITY, WHETHER IN CONTRACT, STRICT LIABILITY, OR TORT (INCLUDING NEGLIGENCE OR OTHERWISE) ARISING IN ANY WAY OUT OF THE USE OF THIS SOFTWARE, EVEN IF ADVISED OF THE POSSIBILITY OF SUCH DAMAGE.

Mozilla Public License Version 2.0

#### 1. Definitions

- 1.1. "Contributor" means each individual or legal entity that creates, contributes to the creation of, or owns Covered Software.
- 1.2. "Contributor Version" means the combination of the Contributions of others (if any) used by a Contributor and that particular Contributor's Contribution.
- 1.3. "Contribution" means Covered Software of a particular Contributor.
- 1.4. "Covered Software" means Source Code Form to which the initial Contributor has attached the notice in Exhibit A, the Executable Form of such Source Code Form, and Modifications of such Source Code Form, in each case including portions thereof.
- 1.5. "Incompatible With Secondary Licenses" means
  - (a) that the initial Contributor has attached the notice described in Exhibit B to the Covered Software; or
  - (b) that the Covered Software was made available under the terms of version 1.1 or earlier of the License, but not also under the terms of a Secondary License.
- 1.6. "Executable Form" means any form of the work other than Source Code Form.
- 1.7. "Larger Work" means a work that combines Covered Software with other material, in a separate file or files, that is not Covered Software.
- 1.8. "License" means this document.
- 1.9. "Licensable" means having the right to grant, to the maximum extent possible, whether at the time of the initial grant or subsequently, any and all of the rights conveyed by this License.
- 1.10. "Modifications" means any of the following:
  - (a) any file in Source Code Form that results from an addition to, deletion from, or modification of the contents of Covered Software; or
  - (b) any new file in Source Code Form that contains any Covered Software.
- 1.11. "Patent Claims" of a Contributor means any patent claim(s), including without limitation, method, process, and apparatus claims, in any patent licensable by such Contributor that would be infringed, but for the grant of the License, by the making, using, selling, offering for sale, having made, import, or transfer of either its Contributions or its Contributor Version.
- 1.12. "Secondary License" means either the GNU General Public License, Version 2.0, the GNU Lesser General Public License, Version 2.1, the GNU Affero General Public License, Version 3.0, or any later versions of those licenses.
- 1.13. "Source Code Form" means the form of the work preferred for making modifications.
- 1.14. "You" (or "Your") means an individual or a legal entity exercising rights under this License. For legal entities, "You" includes any entity that controls, is controlled by, or is under common control with You. For purposes of this definition, "control" means (a) the power, direct or indirect, to cause the direction or management of such entity, whether by contract or otherwise, or (b) ownership of more than fifty percent (50%) of the outstanding shares or beneficial ownership of such entity.

#### 2. License Grants and Conditions

- 2.1. Grants  
Each Contributor hereby grants You a world-wide, royalty-free, non-exclusive license:
  - (a) under intellectual property rights (other than patent or trademark) licensable by such Contributor to use, reproduce, make available, modify, display, perform, distribute, and otherwise exploit its Contributions, either on an unmodified basis, with Modifications, or as part of a Larger Work; and
  - (b) under Patent Claims of such Contributor to make, use, sell, offer for sale, have made, import, and otherwise transfer either its Contributions or its Contributor Version.
- 2.2. Effective Date

The licenses granted in Section 2.1 with respect to any Contribution become effective for each Contribution on the date the Contributor first distributes such Contribution.

# 本機で使われるソフトウェアライセンス情報 (つづき)

## 2.3. Limitations on Grant Scope

The licenses granted in this Section 2 are the only rights granted under this License. No additional rights or licenses will be implied from the distribution or licensing of Covered Software under this License. Notwithstanding Section 2.1 (b) above, no patent license is granted by a Contributor.

- (a) for any code that a Contributor has removed from Covered Software; or
- (b) for infringements caused by: (i) Your and any other third party's modifications of Covered Software, or (ii) the combination of its Contributions with other software (except as part of its Contributor Version); or
- (c) under Patent Claims infringed by Covered Software in the absence of its Contributions.

This License does not grant any rights in the trademarks, service marks, or logos of any Contributor (except as may be necessary to comply with the notice requirements in Section 3.4).

## 2.4. Subsequent Licenses

No Contributor makes additional grants as a result of Your choice to distribute the Covered Software under a subsequent version of this License (see Section 10.2) or under the terms of a Secondary License (if permitted under the terms of Section 3.3).

## 2.5. Representation

Each Contributor represents that the Contributor believes its Contributions are its original creation(s) or it has sufficient rights to grant the rights to its Contributions conveyed by this License.

## 2.6. Fair Use

This License is not intended to limit any rights You have under applicable copyright doctrines of fair use, fair dealing, or other equivalents.

## 2.7. Conditions

Sections 3.1, 3.2, 3.3, and 3.4 are conditions of the licenses granted in Section 2.1.

## 3. Responsibilities

### 3.1. Distribution of Source Form

All distribution of Covered Software in Source Code Form, including any Modifications that You create or to which You contribute, must be under the terms of this License. You must inform recipients that the Source Code Form of the Covered Software is governed by the terms of this License, and how they can obtain a copy of this License. You may not attempt to alter or restrict the recipients' rights in the Source Code Form.

### 3.2. Distribution of Executable Form

If You distribute Covered Software in Executable Form then:

- (a) such Covered Software must also be made available in Source Code Form, as described in Section 3.1, and You must inform recipients of the Executable Form how they can obtain a copy of such Source Code Form by reasonable means in a timely manner, at a charge no more than the cost of distribution to the recipient; and
- (b) You may distribute such Executable Form under the terms of this License, or sublicense it under different terms, provided that the license for the Executable Form does not attempt to limit or alter the recipients' rights in the Source Code Form under this License.

### 3.3. Distribution of a Larger Work

You may create and distribute a Larger Work under terms of Your choice, provided that You also comply with the requirements of this License for the Covered Software. If the Larger Work is a combination of Covered Software with a work governed by one or more Secondary Licenses, and the Covered Software is not Incompatible With Secondary Licenses, this License permits You to additionally distribute such Covered Software under the terms of such Secondary License(s), so that the recipient of the Larger Work may, at their option, further distribute the Covered Software under the terms of either this License or such Secondary License(s).

### 3.4. Notices

You may not remove or alter the substance of any license notices (including copyright notices, patent notices, disclaimers of warranty, or limitations of liability) contained within the Source Code Form of the Covered Software, except that You may alter any license notices to the extent required to remedy known factual inaccuracies.

### 3.5. Application of Additional Terms

You may choose to offer, and to charge a fee for, warranty, support, indemnity or liability obligations to one or more recipients of Covered Software. However, You may do so only on Your own behalf, and not on behalf of any Contributor. You must make it absolutely clear that any such warranty, support, indemnity, or liability obligation is offered by You alone, and You hereby agree to indemnify every Contributor for any liability incurred by such Contributor as a result of warranty, support, indemnity or liability terms You offer. You may include additional disclaimers of warranty and limitations of liability specific to any jurisdiction.

## 4. Inability to Comply Due to Statute or Regulation

If it is impossible for You to comply with any of the terms of this License with respect to some or all of the Covered Software due to statute, judicial order, or regulation then You must: (a) comply with the terms of this License to the maximum extent possible; and (b) describe the limitations and the code they affect. Such description must be placed in a text file included with all distributions of the Covered Software under this License. Except to the extent prohibited by statute or regulation, such description must be sufficient to allow a recipient of ordinary skill to be able to understand it.

## 5. Termination

5.1. The rights granted under this License will terminate automatically if You fail to comply with any of its terms. However, if You become compliant, then the rights granted under this License from a particular Contributor are reinstated (a) provisionally, unless and until such Contributor explicitly and finally terminates Your grants, and (b) on an ongoing basis, if such Contributor fails to notify You of the non-compliance by some reasonable means prior to 60 days after You have come back into compliance. Moreover, Your grants from a particular Contributor are reinstated on an ongoing basis if such Contributor notifies You of the non-compliance by some reasonable means, this is the first time You have received notice of non-compliance with this License from such Contributor, and You become compliant prior to 30 days after Your receipt of the notice.

5.2. If You initiate litigation against any entity by asserting a patent infringement claim (excluding declaratory judgment actions, counter-claims, and cross-claims) alleging that a Contributor Version directly or indirectly infringes any patent, then the rights granted to You by any and all Contributors for the Covered Software under Section 2.1 of this License shall terminate.

5.3. In the event of termination under Sections 5.1 or 5.2 above, all end user license agreements (excluding distributors and resellers) which have been validly granted by You or Your distributors under this License prior to termination shall survive termination.

```
*****
*
* 6. Disclaimer of Warranty
*
*
* Covered Software is provided under this License on an "as is"
* basis, without warranty of any kind, either expressed, implied, or
* statutory, including, without limitation, warranties that the
* Covered Software is free of defects, merchantable, fit for a
* particular purpose or non-infringing. The entire risk as to the
* quality and performance of the Covered Software is with You.
* Should any Covered Software prove defective in any respect, You
* (not any Contributor) assume the cost of any necessary servicing,
* repair, or correction. This disclaimer of warranty constitutes an
* essential part of this License. No use of any Covered Software is
* authorized under this License except under this disclaimer.
*****
```

```
*****
*
* 7. Limitation of Liability
*
*
* Under no circumstances and under no legal theory, whether tort
* (including negligence), contract, or otherwise, shall any
* Contributor, or anyone who distributes Covered Software as
* permitted above, be liable to You for any direct, indirect,
* special, incidental, or consequential damages of any character
* including, without limitation, damages for lost profits, loss of
* goodwill, work stoppage, computer failure or malfunction, or any
* and all other commercial damages or losses, even if such party
* shall have been informed of the possibility of such damages. This
* limitation of liability shall not apply to liability for death or
* personal injury resulting from such party's negligence to the
* extent applicable law prohibits such limitation. Some
* jurisdictions do not allow the exclusion or limitation of
* incidental or consequential damages, so this exclusion and
* limitation may not apply to You.
*****
```

## 8. Litigation

Any litigation relating to this License may be brought only in the courts of a jurisdiction where the defendant maintains its principal place of business and such litigation shall be governed by laws of that jurisdiction, without reference to its conflict-of-law provisions. Nothing in this Section shall prevent a party's ability to bring cross-claims or counter-claims.

## 9. Miscellaneous

This License represents the complete agreement concerning the subject matter hereof. If any provision of this License is held to be unenforceable, such provision shall be reformed only to the extent necessary to make it enforceable. Any law or regulation which provides that the language of a contract shall be construed against the drafter shall not be used to construe this License against a Contributor.

## 10. Versions of the License

### 10.1. New Versions

Mozilla Foundation is the license steward. Except as provided in Section 10.3, no one other than the license steward has the right to modify or publish new versions of this License. Each version will be given a distinguishing version number.

### 10.2. Effect of New Versions

You may distribute the Covered Software under the terms of the version of the License under which You originally received the Covered Software, or under the terms of any subsequent version published by the license steward.

### 10.3. Modified Versions

If you create software not governed by this License, and you want to create a new license for such software, you may create and use a modified version of this License if you rename the license and remove any references to the name of the license steward (except to note that such modified license differs from this License).

### 10.4. Distributing Source Code Form that is Incompatible With Secondary Licenses

If You choose to distribute Source Code Form that is Incompatible With Secondary Licenses under the terms of this version of the License, the notice described in Exhibit B of this License must be attached.

#### Exhibit A - Source Code Form License Notice

This Source Code Form is subject to the terms of the Mozilla Public License, v. 2.0. If a copy of the MPL was not distributed with this file, You can obtain one at <http://mozilla.org/MPL/2.0/>.

If it is not possible or desirable to put the notice in a particular file, then You may include the notice in a location (such as a LICENSE file in a relevant directory) where a recipient would be likely to look for such a notice.

You may add additional accurate notices of copyright ownership.

#### Exhibit B - "Incompatible With Secondary Licenses" Notice

This Source Code Form is "Incompatible With Secondary Licenses", as defined by the Mozilla Public License, v. 2.0.

NSS is available under the Mozilla Public License, version 2, a copy of which is below.

#### Note on GPL Compatibility

The MPL 2, section 3.3, permits you to combine NSS with code under the GNU General Public License (GPL) version 2, or any later version of that license, to make a Larger Work, and distribute the result under the GPL. The only condition is that you must also make NSS, and any changes you

have made to it, available to recipients under the terms of the MPL 2 also.

Anyone who receives the combined code from you does not have to continue to dual license in this way, and may, if they wish, distribute under the terms of either of the two licenses - either the MPL alone or the GPL alone. However, we discourage people from distributing copies of NSS under the GPL alone, because it means that any improvements they make cannot be reincorporated into the main version of NSS. There is never a need to do this for license compatibility reasons.

#### Note on LGPL Compatibility

The above also applies to combining MPLed code in a single library with code under the GNU Lesser General Public License (LGPL) version 2.1, or any later version of that license. If the LGPLed code and the MPLed code are not in the same library, then the copyleft coverage of the two licenses does not overlap, so no issues arise.

#### Mozilla Public License Version 2.0

##### 1. Definitions

- 1.1. "Contributor" means each individual or legal entity that creates, contributes to the creation of, or owns Covered Software.
- 1.2. "Contributor Version" means the combination of the Contributions of others (if any) used by a Contributor and that particular Contributor's Contribution.
- 1.3. "Contribution" means Covered Software of a particular Contributor.
- 1.4. "Covered Software" means Source Code Form to which the initial Contributor has attached the notice in Exhibit A, the Executable Form of such Source Code Form, and Modifications of such Source Code Form, in each case including portions thereof.
- 1.5. "Incompatible With Secondary Licenses" means
  - (a) that the initial Contributor has attached the notice described in Exhibit B to the Covered Software; or
  - (b) that the Covered Software was made available under the terms of version 1.1 or earlier of the License, but not also under the terms of a Secondary License.
- 1.6. "Executable Form" means any form of the work other than Source Code Form.
- 1.7. "Larger Work" means a work that combines Covered Software with other material, in a separate file or files, that is not Covered Software.
- 1.8. "License" means this document.
- 1.9. "Licensable" means having the right to grant, to the maximum extent possible, whether at the time of the initial grant or subsequently, any and all of the rights conveyed by this License.
- 1.10. "Modifications" means any of the following:
  - (a) any file in Source Code Form that results from an addition to, deletion from, or modification of the contents of Covered Software; or
  - (b) any new file in Source Code Form that contains any Covered Software.
- 1.11. "Patent Claims" of a Contributor means any patent claim(s), including without limitation, method, process, and apparatus claims, in any patent Licensable by such Contributor that would be infringed, but for the grant of the License, by the making, using, selling, offering for sale, having made, import, or transfer of either its Contributions or its Contributor Version.
- 1.12. "Secondary License" means either the GNU General Public License, Version 2.0, the GNU Lesser General Public License, Version 2.1, the GNU Affero General Public License, Version 3.0, or any later versions of those licenses.
- 1.13. "Source Code Form" means the form of the work preferred for making modifications.
- 1.14. "You" (or "Your") means an individual or a legal entity exercising rights under this License. For legal entities, "You" includes any entity that controls, is controlled by, or is under common control with You. For purposes of this definition, "control" means (a) the power, direct or indirect, to cause the direction or management of such entity, whether by contract or otherwise, or (b) ownership of more than fifty percent (50%) of the outstanding shares or beneficial ownership of such entity.

##### 2. License Grants and Conditions

###### 2.1. Grants

Each Contributor hereby grants You a world-wide, royalty-free, non-exclusive license:

- (a) under intellectual property rights (other than patent or trademark) Licensable by such Contributor to use, reproduce, make available, modify, display, perform, distribute, and otherwise exploit its Contributions, either on an unmodified basis, with Modifications, or as part of a Larger Work; and
- (b) under Patent Claims of such Contributor to make, use, sell, offer for sale, have made, import, and otherwise transfer either its Contributions or its Contributor Version.

###### 2.2. Effective Date

The licenses granted in Section 2.1 with respect to any Contribution become effective for each Contribution on the date the Contributor first distributes such Contribution.

###### 2.3. Limitations on Grant Scope

The licenses granted in this Section 2 are the only rights granted under this License. No additional rights or licenses will be implied from the distribution or licensing of Covered Software under this License. Notwithstanding Section 2.1(b) above, no patent license is granted by a Contributor:

- (a) for any code that a Contributor has removed from Covered Software; or

- (b) for infringements caused by: (i) Your and any other third party's modifications of Covered Software, or (ii) the combination of its Contributions with other software (except as part of its Contributor Version); or

- (c) under Patent Claims infringed by Covered Software in the absence of its Contributions.

This License does not grant any rights in the trademarks, service marks, or logos of any Contributor (except as may be necessary to comply with the notice requirements in Section 3.4).

###### 2.4. Subsequent Licenses

No Contributor makes additional grants as a result of Your choice to distribute the Covered Software under a subsequent version of this License (see Section 10.2) or under the terms of a Secondary License (if permitted under the terms of Section 3.5).

###### 2.5. Representation

Each Contributor represents that the Contributor believes its Contributions are its original creation(s) or it has sufficient rights to grant the rights to its Contributions conveyed by this License.

###### 2.6. Fair Use

This License is not intended to limit any rights You have under applicable copyright doctrines of fair use, fair dealing, or other equivalents.

###### 2.7. Conditions

Sections 3.1, 3.2, 3.3, and 3.4 are conditions of the licenses granted in Section 2.1.

##### 3. Responsibilities

###### 3.1. Distribution of Source Form

All distribution of Covered Software in Source Code Form, including any Modifications that You create or to which You contribute, must be under the terms of this License. You must inform recipients that the Source Code Form of the Covered Software is governed by the terms of this License, and how they can obtain a copy of this License. You may not attempt to alter or restrict the recipients' rights in the Source Code Form.

###### 3.2. Distribution of Executable Form

If You distribute Covered Software in Executable Form then:

- (a) such Covered Software must also be made available in Source Code Form, as described in Section 3.1, and You must inform recipients of the Executable Form how they can obtain a copy of such Source Code Form by reasonable means in a timely manner, at a charge no more than the cost of distribution to the recipient; and
- (b) You may distribute such Executable Form under the terms of this License, or sublicense it under different terms, provided that the license for the Executable Form does not attempt to limit or alter the recipients' rights in the Source Code Form under this License.

###### 3.3. Distribution of a Larger Work

You may create and distribute a Larger Work under terms of Your choice, provided that You also comply with the requirements of this License for the Covered Software. If the Larger Work is a combination of Covered Software with a work governed by one or more Secondary Licenses, and the Covered Software is not Incompatible With Secondary Licenses, this License permits You to additionally distribute such Covered Software under the terms of such Secondary License(s), so that the recipient of the Larger Work may, at their option, further distribute the Covered Software under the terms of either this License or such Secondary License(s).

###### 3.4. Notices

You may not remove or alter the substance of any license notices (including copyright notices, patent notices, disclaimers of warranty, or limitations of liability) contained within the Source Code Form of the Covered Software, except that You may alter any license notices to the extent required to remedy known factual inaccuracies.

###### 3.5. Application of Additional Terms

You may choose to offer, and to charge a fee for, warranty, support, indemnity or liability obligations to one or more recipients of Covered Software. However, You may do so only on Your own behalf, and not on behalf of any Contributor. You must make it absolutely clear that any such warranty, support, indemnity, or liability obligation is offered by You alone, and You hereby agree to indemnify every Contributor for any liability incurred by such Contributor as a result of warranty, support, indemnity or liability terms You offer. You may include additional disclaimers of warranty and limitations of liability specific to any jurisdiction.

##### 4. Inability to Comply Due to Statute or Regulation

If it is impossible for You to comply with any of the terms of this License with respect to some or all of the Covered Software due to statute, judicial order, or regulation then You must: (a) comply with the terms of this License to the maximum extent possible; and (b) describe the limitations and the code they affect. Such description must be placed in a text file included with all distributions of the Covered Software under this License. Except to the extent prohibited by statute or regulation, such description must be sufficiently detailed for a recipient of ordinary skill to be able to understand it.

##### 5. Termination

5.1. The rights granted under this License will terminate automatically if You fail to comply with any of its terms. However, if You become compliant, then the rights granted under this License from a particular Contributor are reinstated (a) provisionally, unless and until such Contributor explicitly and finally terminates Your grants, and (b) on an ongoing basis, if such Contributor fails to notify You of the non-compliance by some reasonable means prior to 60 days after You have come back into compliance. Moreover, Your grants from a particular Contributor are reinstated on an ongoing basis if such Contributor notifies You of the non-compliance by some reasonable means, this is the first time You have received notice of non-compliance with this License from such Contributor, and You become compliant prior to 30 days after Your receipt of the notice.

5.2. If You initiate litigation against any entity by asserting a patent infringement claim (excluding declaratory judgment actions, counter-claims, and cross-claims) alleging that a Contributor Version directly or indirectly infringes any patent, then the rights granted to You by any and all Contributors for the Covered Software under Section 2.1 of this License shall terminate.

5.3. In the event of termination under Sections 5.1 or 5.2 above, all end user license agreements (excluding distributors and resellers) which have been validly granted by You or Your distributors under this License

# 本機で使われるソフトウェアライセンス情報 (つづき)

prior to termination shall survive termination.

```
*****
*                                     *
* 6. Disclaimer of Warranty           *
* -----                           *
*                                     *
* Covered Software is provided under this License on an "as is" *
* basis, without warranty of any kind, either expressed, implied, or *
* statutory, including, without limitation, warranties that the *
* Covered Software is free of defects, merchantable, fit for a *
* particular purpose or non-infringing. The entire risk as to the *
* quality and performance of the Covered Software is with You. *
* Should any Covered Software prove defective in any respect, You *
* (not any Contributor) assume the cost of any necessary servicing, *
* repair, or correction. This disclaimer of warranty constitutes an *
* essential part of this License. No use of any Covered Software is *
* authorized under this License except under this disclaimer.
*****
```

```
*****
*                                     *
* 7. Limitation of Liability         *
* -----                           *
*                                     *
* Under no circumstances and under no legal theory, whether tort *
* (including negligence), contract, or otherwise, shall any *
* Contributor, or anyone who distributes Covered Software as *
* permitted above, be liable to You for any direct, indirect, *
* special, incidental, or consequential damages of any character *
* including, without limitation, damages for lost profits, loss of *
* goodwill, work stoppage, computer failure or malfunction, or any *
* and all other commercial damages or losses, even if such party *
* shall have been informed of the possibility of such damages. This *
* limitation of liability shall not apply to liability for death or *
* personal injury resulting from such party's negligence to the *
* extent applicable law prohibits such limitation. Some *
* jurisdictions do not allow the exclusion or limitation of *
* incidental or consequential damages, so this exclusion and *
* limitation may not apply to You.
*****
```

## 8. Litigation

Any litigation relating to this License may be brought only in the courts of a jurisdiction where the defendant maintains its principal place of business and such litigation shall be governed by laws of that jurisdiction, without reference to its conflict-of-law provisions. Nothing in this Section shall prevent a party's ability to bring cross-claims or counter-claims.

## 9. Miscellaneous

This License represents the complete agreement concerning the subject matter hereof. If any provision of this License is held to be unenforceable, such provision shall be reformed only to the extent necessary to make it enforceable. Any law or regulation which provides that the language of a contract shall be construed against the drafter shall not be used to construe this License against a Contributor.

## 10. Versions of the License

### 10.1. New Versions

Mozilla Foundation is the license steward. Except as provided in Section 10.3, no one other than the license steward has the right to modify or publish new versions of this License. Each version will be given a distinguishing version number.

### 10.2. Effect of New Versions

You may distribute the Covered Software under the terms of the version of the License under which You originally received the Covered Software, or under the terms of any subsequent version published by the license steward.

### 10.3. Modified Versions

If you create software not governed by this License, and you want to create a new license for such software, you may create and use a modified version of this License if you rename the license and remove any references to the name of the license steward (except to note that such modified license differs from this License).

### 10.4. Distributing Source Code Form that is Incompatible With Secondary Licenses

If You choose to distribute Source Code Form that is Incompatible With Secondary Licenses under the terms of this version of the License, the notice described in Exhibit B of this License must be attached.

#### Exhibit A - Source Code Form License Notice

This Source Code Form is subject to the terms of the Mozilla Public License, v. 2.0. If a copy of the MPL was not distributed with this file, You can obtain one at <http://mozilla.org/MPL/2.0/>.

If it is not possible or desirable to put the notice in a particular file, then You may include the notice in a location (such as a LICENSE file in a relevant directory) where a recipient would be likely to look for such a notice.

You may add additional accurate notices of copyright ownership.

#### Exhibit B - "Incompatible With Secondary Licenses" Notice

This Source Code Form is "Incompatible With Secondary Licenses", as defined by the Mozilla Public License, v. 2.0.

Copyright (c) 2013, Cisco Systems All rights reserved.

Redistribution and use in source and binary forms, with or without modification, are permitted provided that the following conditions are met:

- \* Redistributions of source code must retain the above copyright notice, this list of conditions and the following disclaimer.
- \* Redistributions in binary form must reproduce the above copyright notice, this list of conditions and the following disclaimer in the documentation and/or other materials provided with the distribution.

THIS SOFTWARE IS PROVIDED BY THE COPYRIGHT HOLDERS AND CONTRIBUTORS "AS IS" AND ANY EXPRESS OR IMPLIED WARRANTIES, INCLUDING, BUT NOT LIMITED TO, THE IMPLIED WARRANTIES OF MERCHANTABILITY AND FITNESS FOR A PARTICULAR PURPOSE ARE DISCLAIMED. IN NO EVENT SHALL THE COPYRIGHT HOLDER OR CONTRIBUTORS BE LIABLE FOR ANY DIRECT, INDIRECT, INCIDENTAL, SPECIAL, EXEMPLARY, OR CONSEQUENTIAL DAMAGES (INCLUDING, BUT NOT LIMITED TO, PROCUREMENT OF SUBSTITUTE GOODS OR SERVICES; LOSS OF USE, DATA, OR PROFITS; OR BUSINESS INTERRUPTION) HOWEVER CAUSED AND ON

ANY THEORY OF LIABILITY, WHETHER IN CONTRACT, STRICT LIABILITY, OR TORT (INCLUDING NEGLIGENCE OR OTHERWISE) ARISING IN ANY WAY OUT OF THE USE OF THIS SOFTWARE, EVEN IF ADVISED OF THE POSSIBILITY OF SUCH DAMAGE.

Copyright (c) 2018, openjpeg  
All rights reserved.

Redistribution and use in source and binary forms, with or without modification, are permitted provided that the following conditions are met:

1. Redistributions of source code must retain the above copyright notice, this list of conditions and the following disclaimer.
2. Redistributions in binary form must reproduce the above copyright notice, this list of conditions and the following disclaimer in the documentation and/or other materials provided with the distribution.

THIS SOFTWARE IS PROVIDED BY THE COPYRIGHT HOLDERS AND CONTRIBUTORS "AS IS" AND ANY EXPRESS OR IMPLIED WARRANTIES, INCLUDING, BUT NOT LIMITED TO, THE IMPLIED WARRANTIES OF MERCHANTABILITY AND FITNESS FOR A PARTICULAR PURPOSE ARE DISCLAIMED. IN NO EVENT SHALL THE COPYRIGHT OWNER OR CONTRIBUTORS BE LIABLE FOR ANY DIRECT, INDIRECT, INCIDENTAL, SPECIAL, EXEMPLARY, OR CONSEQUENTIAL DAMAGES (INCLUDING, BUT NOT LIMITED TO, PROCUREMENT OF SUBSTITUTE GOODS OR SERVICES; LOSS OF USE, DATA, OR PROFITS; OR BUSINESS INTERRUPTION) HOWEVER CAUSED AND ON ANY THEORY OF LIABILITY, WHETHER IN CONTRACT, STRICT LIABILITY, OR TORT (INCLUDING NEGLIGENCE OR OTHERWISE) ARISING IN ANY WAY OUT OF THE USE OF THIS SOFTWARE, EVEN IF ADVISED OF THE POSSIBILITY OF SUCH DAMAGE.

The views and conclusions contained in the software and documentation are those of the authors and should not be interpreted as representing official policies, either expressed or implied, of the FreeBSD Project.

Contributions to the collaboration shall not be considered confidential.

Each contributor represents and warrants that it has the right and authority to license copyright in its contributions to the collaboration.

Each contributor agrees to license the copyright in the contributions under the Modified (2-clause or 3-clause) BSD License or the Clear BSD License.

Please see the IPR statements submitted to the IETF for the complete patent licensing details:

Xiph.Org Foundation:  
<https://datatracker.ietf.org/ipr/1524/>

Microsoft Corporation:  
<https://datatracker.ietf.org/ipr/1914/>

Skype Limited:  
<https://datatracker.ietf.org/ipr/1602/>

Broadcom Corporation:  
<https://datatracker.ietf.org/ipr/1526/>

```
// Copyright (c) 2009 The Chromium Authors. All rights reserved.
//
// Redistribution and use in source and binary forms, with or without
// modification, are permitted provided that the following conditions are
// met:
//
// * Redistributions of source code must retain the above copyright
// notice, this list of conditions and the following disclaimer.
// * Redistributions in binary form must reproduce the above
// copyright notice, this list of conditions and the following disclaimer
// in the documentation and/or other materials provided with the
// distribution.
// * Neither the name of Google Inc. nor the names of its
// contributors may be used to endorse or promote products derived from
// this software without specific prior written permission.
//
// THIS SOFTWARE IS PROVIDED BY THE COPYRIGHT HOLDERS AND CONTRIBUTORS
// "AS IS" AND ANY EXPRESS OR IMPLIED WARRANTIES, INCLUDING, BUT NOT
// LIMITED TO, THE IMPLIED WARRANTIES OF MERCHANTABILITY AND FITNESS FOR
// A PARTICULAR PURPOSE ARE DISCLAIMED. IN NO EVENT SHALL THE COPYRIGHT
// OWNER OR CONTRIBUTORS BE LIABLE FOR ANY DIRECT, INDIRECT, INCIDENTAL,
// SPECIAL, EXEMPLARY, OR CONSEQUENTIAL DAMAGES (INCLUDING, BUT NOT
// LIMITED TO, PROCUREMENT OF SUBSTITUTE GOODS OR SERVICES; LOSS OF USE,
// DATA, OR PROFITS; OR BUSINESS INTERRUPTION) HOWEVER CAUSED AND ON ANY
// THEORY OF LIABILITY, WHETHER IN CONTRACT, STRICT LIABILITY, OR TORT
// (INCLUDING NEGLIGENCE OR OTHERWISE) ARISING IN ANY WAY OUT OF THE USE
// OF THIS SOFTWARE, EVEN IF ADVISED OF THE POSSIBILITY OF SUCH DAMAGE.
```

This copy of the libpng notices is provided for your convenience. In case of any discrepancy between this copy and the notices in the file png.h that is included in the libpng distribution, the latter shall prevail.

#### COPYRIGHT NOTICE, DISCLAIMER, and LICENSE:

If you modify libpng you may insert additional notices immediately following this sentence.

pngusr.h is distributed under the MPL 1.1/GPL 2.0/LGPL 2.1 tri-license.

This code is released under the libpng license.

libpng versions 1.0.7, July 1, 2000, through 1.2.56, December 17, 2015, are Copyright (c) 2000-2002, 2004, 2006-2015 Glenn Randers-Pehrson, are derived from libpng-1.0.6, and are distributed according to the same disclaimer and license as libpng-1.0.6 with the following individuals added to the list of Contributing Authors:

- Simon-Pierre Cadieux
- Eric S. Raymond
- Cosmin Truta
- Gilles Vollant

and with the following additions to the disclaimer:

There is no warranty against interference with your enjoyment of the library or against infringement. There is no warranty that our efforts or the library will fulfill any of your particular purposes or needs. This library is provided with all faults, and the entire risk of satisfactory quality, performance, accuracy, and effort is with the user.

libpng versions 0.97, January 1998, through 1.0.6, March 20, 2000, are Copyright (c) 1998-2000 Glenn Randers-Pehrson, are derived from libpng-0.96, and are distributed according to the same disclaimer and license as libpng-0.96, with the following individuals added to the list of Contributing Authors:

- Tom Lane
- Glenn Randers-Pehrson
- Willem van Schaik

libpng versions 0.89, June 1996, through 0.96, May 1997, are



Copyright (c) 1996-1997 Andreas Dilger, are derived from libpng-0.88, and are distributed according to the same disclaimer and license as libpng-0.88, with the following individuals added to the list of Contributing Authors:

John Bowler  
Kevin Bracey  
Sam Bushell  
Magnus Holmgren  
Greg Rodel  
Tom Tanner

libpng versions 0.5, May 1995, through 0.88, January 1996, are Copyright (c) 1995-1996 Guy Eric Schalnat, Group 42, Inc.

For the purposes of this copyright and license, "Contributing Authors" is defined as the following set of individuals:

Andreas Dilger  
Dave Martindale  
Guy Eric Schalnat  
Paul Schmidt  
Tim Wegner

The PNG Reference Library is supplied "AS IS". The Contributing Authors and Group 42, Inc. disclaim all warranties, expressed or implied, including, without limitation, the warranties of merchantability and of fitness for any purpose. The Contributing Authors and Group 42, Inc. assume no liability for direct, indirect, incidental, special, exemplary, or consequential damages, which may result from the use of the PNG Reference Library, even if advised of the possibility of such damage.

Permission is hereby granted to use, copy, modify, and distribute this source code, or portions hereof, for any purpose, without fee, subject to the following restrictions:

1. The origin of this source code must not be misrepresented.
2. Altered versions must be plainly marked as such and must not be misrepresented as being the original source.
3. This Copyright notice may not be removed or altered from any source or altered source distribution.

The Contributing Authors and Group 42, Inc. specifically permit, without fee, and encourage the use of this source code as a component to supporting the PNG file format in commercial products. If you use this source code in a product, acknowledgment is not required but would be appreciated.

END OF COPYRIGHT NOTICE, DISCLAIMER, and LICENSE.

A "png\_get\_copyright" function is available, for convenient use in "about" boxes and the like:

```
printf("%s", png_get_copyright(NULL));
```

Also, the PNG logo (in PNG format, of course) is supplied in the files "pngbar.png" and "pngbar.jpg (88x31)" and "pngnow.png" (98x31).

Libpng is OSI Certified Open Source Software. OSI Certified Open Source is a certification mark of the Open Source Initiative. OSI has not addressed the additional disclaimers inserted at version 1.0.7.

Glenn Randers-Pehrson  
glennrp at users.sourceforge.net  
December 17, 2015

Copyright 2008, Google Inc.  
All rights reserved.

Redistribution and use in source and binary forms, with or without modification, are permitted provided that the following conditions are met:

- \* Redistributions of source code must retain the above copyright notice, this list of conditions and the following disclaimer.
- \* Redistributions in binary form must reproduce the above copyright notice, this list of conditions and the following disclaimer in the documentation and/or other materials provided with the distribution.
- \* Neither the name of Google Inc. nor the names of its contributors may be used to endorse or promote products derived from this software without specific prior written permission.

THIS SOFTWARE IS PROVIDED BY THE COPYRIGHT HOLDERS AND CONTRIBUTORS "AS IS" AND ANY EXPRESS OR IMPLIED WARRANTIES, INCLUDING, BUT NOT LIMITED TO, THE IMPLIED WARRANTIES OF MERCHANTABILITY AND FITNESS FOR A PARTICULAR PURPOSE ARE DISCLAIMED. IN NO EVENT SHALL THE COPYRIGHT OWNER OR CONTRIBUTORS BE LIABLE FOR ANY DIRECT, INDIRECT, INCIDENTAL, SPECIAL, EXEMPLARY, OR CONSEQUENTIAL DAMAGES (INCLUDING, BUT NOT LIMITED TO, PROCUREMENT OF SUBSTITUTE GOODS OR SERVICES; LOSS OF USE, DATA, OR PROFITS; OR BUSINESS INTERRUPTION) HOWEVER CAUSED AND ON ANY THEORY OF LIABILITY, WHETHER IN CONTRACT, STRICT LIABILITY, OR TORT (INCLUDING NEGLIGENCE OR OTHERWISE) ARISING IN ANY WAY OUT OF THE USE OF THIS SOFTWARE, EVEN IF ADVISED OF THE POSSIBILITY OF SUCH DAMAGE.

Code generated by the Protocol Buffer compiler is owned by the owner of the input file used when generating it. This code is not standalone and requires a support library to be linked with it. This support library is itself covered by the above license.

gcms  
Copyright (C) 2009 Mozilla Corporation  
Copyright (C) 1998-2007 Marti Maria

Permission is hereby granted, free of charge, to any person obtaining a copy of this software and associated documentation files (the "Software"), to deal in the Software without restriction, including without limitation the rights to use, copy, modify, merge, publish, distribute, sublicense, and/or sell copies of the Software, and to permit persons to whom the Software is furnished to do so, subject to the following conditions:

The above copyright notice and this permission notice shall be included in all copies or substantial portions of the Software.

THE SOFTWARE IS PROVIDED "AS IS", WITHOUT WARRANTY OF ANY KIND, EXPRESS OR IMPLIED, INCLUDING BUT NOT LIMITED TO THE WARRANTIES OF MERCHANTABILITY, FITNESS FOR A PARTICULAR PURPOSE AND NONINFRINGEMENT. IN NO EVENT SHALL THE AUTHORS OR COPYRIGHT HOLDERS BE LIABLE FOR ANY CLAIM, DAMAGES OR OTHER LIABILITY, WHETHER IN AN ACTION OF CONTRACT, TORT OR OTHERWISE, ARISING FROM, OUT OF OR IN CONNECTION WITH THE SOFTWARE OR THE USE OR OTHER DEALINGS IN THE SOFTWARE.

```
// Copyright (c) 2009 The RE2 Authors. All rights reserved.
```

```
// Redistribution and use in source and binary forms, with or without  
// modification, are permitted provided that the following conditions are  
// met:
```

```
// * Redistributions of source code must retain the above copyright  
// notice, this list of conditions and the following disclaimer.  
// * Redistributions in binary form must reproduce the above  
// copyright notice, this list of conditions and the following disclaimer  
// in the documentation and/or other materials provided with the  
// distribution.  
// * Neither the name of Google Inc. nor the names of its  
// contributors may be used to endorse or promote products derived from  
// this software without specific prior written permission.
```

```
// THIS SOFTWARE IS PROVIDED BY THE COPYRIGHT HOLDERS AND CONTRIBUTORS  
// "AS IS" AND ANY EXPRESS OR IMPLIED WARRANTIES, INCLUDING, BUT NOT  
// LIMITED TO, THE IMPLIED WARRANTIES OF MERCHANTABILITY AND FITNESS FOR  
// A PARTICULAR PURPOSE ARE DISCLAIMED. IN NO EVENT SHALL THE COPYRIGHT  
// OWNER OR CONTRIBUTORS BE LIABLE FOR ANY DIRECT, INDIRECT, INCIDENTAL,  
// SPECIAL, EXEMPLARY, OR CONSEQUENTIAL DAMAGES (INCLUDING, BUT NOT  
// LIMITED TO, PROCUREMENT OF SUBSTITUTE GOODS OR SERVICES; LOSS OF USE,  
// DATA, OR PROFITS; OR BUSINESS INTERRUPTION) HOWEVER CAUSED AND ON ANY  
// THEORY OF LIABILITY, WHETHER IN CONTRACT, STRICT LIABILITY, OR TORT  
// (INCLUDING NEGLIGENCE OR OTHERWISE) ARISING IN ANY WAY OUT OF THE USE  
// OF THIS SOFTWARE, EVEN IF ADVISED OF THE POSSIBILITY OF SUCH DAMAGE.
```

Copyright (c) 2011, The WebRTC project authors. All rights reserved.

Redistribution and use in source and binary forms, with or without modification, are permitted provided that the following conditions are met:

- \* Redistributions of source code must retain the above copyright notice, this list of conditions and the following disclaimer.

- \* Redistributions in binary form must reproduce the above copyright notice, this list of conditions and the following disclaimer in the documentation and/or other materials provided with the distribution.

- \* Neither the name of Google nor the names of its contributors may be used to endorse or promote products derived from this software without specific prior written permission.

THIS SOFTWARE IS PROVIDED BY THE COPYRIGHT HOLDERS AND CONTRIBUTORS "AS IS" AND ANY EXPRESS OR IMPLIED WARRANTIES, INCLUDING, BUT NOT LIMITED TO, THE IMPLIED WARRANTIES OF MERCHANTABILITY AND FITNESS FOR A PARTICULAR PURPOSE ARE DISCLAIMED. IN NO EVENT SHALL THE COPYRIGHT HOLDER OR CONTRIBUTORS BE LIABLE FOR ANY DIRECT, INDIRECT, INCIDENTAL, SPECIAL, EXEMPLARY, OR CONSEQUENTIAL DAMAGES (INCLUDING, BUT NOT LIMITED TO, PROCUREMENT OF SUBSTITUTE GOODS OR SERVICES; LOSS OF USE, DATA, OR PROFITS; OR BUSINESS INTERRUPTION) HOWEVER CAUSED AND ON ANY THEORY OF LIABILITY, WHETHER IN CONTRACT, STRICT LIABILITY, OR TORT (INCLUDING NEGLIGENCE OR OTHERWISE) ARISING IN ANY WAY OUT OF THE USE OF THIS SOFTWARE, EVEN IF ADVISED OF THE POSSIBILITY OF SUCH DAMAGE.

Apache License  
Version 2.0, January 2004  
<http://www.apache.org/licenses/>

TERMS AND CONDITIONS FOR USE, REPRODUCTION, AND DISTRIBUTION

1. Definitions.

"License" shall mean the terms and conditions for use, reproduction, and distribution as defined by Sections 1 through 9 of this document.

"Licensor" shall mean the copyright owner or entity authorized by the copyright owner that is granting the License.

"Legal Entity" shall mean the union of the acting entity and all other entities that control, are controlled by, or are under common control with that entity. For the purposes of this definition, "control" means (i) the power, direct or indirect, to cause the direction or management of such entity, whether by contract or otherwise, or (ii) ownership of fifty percent (50%) or more of the outstanding shares, or (iii) beneficial ownership of such entity.

"You" (or "Your") shall mean an individual or Legal Entity exercising permissions granted by this License.

"Source" form shall mean the preferred form for making modifications, including but not limited to software source code, documentation source, and configuration files.

"Object" form shall mean any form resulting from mechanical transformation or translation of a Source form, including but not limited to compiled object code, generated documentation, and conversions to other media types.

"Work" shall mean the work of authorship, whether in Source or Object form, made available under the License, as indicated by a copyright notice that is included in or attached to the work (an example is provided in the Appendix below).

"Derivative Works" shall mean any work, whether in Source or Object form, that is based on (or derived from) the Work and for which the editorial revisions, annotations, elaborations, or other modifications represent, as a whole, an original work of authorship. For the purposes of this License, Derivative Works shall not include works that remain separable from, or merely link (or bind by name) to the interfaces of, the Work and Derivative Works thereon.

"Contribution" shall mean any work of authorship, including the original version of the Work and any modifications or additions to that Work or Derivative Works thereof, that is intentionally submitted to Licensor for inclusion in the Work by the copyright owner or by an individual or legal entity authorized to submit on behalf of the copyright owner. For the purposes of this definition, "submitted" means any form of electronic, verbal, or written communication sent to the Licensor or its representatives, including but not limited to communication on electronic mailing lists, source code control systems, and issue tracking systems that are managed by, or on behalf of, the Licensor for the purpose of discussing and improving the Work, but excluding communication that is conspicuously marked or otherwise designated in writing by the copyright owner as "Not a Contribution."

"Contributor" shall mean Licensor and any individual or Legal Entity on behalf of whom a Contribution has been received by Licensor and subsequently incorporated within the Work.

2. Grant of Copyright License. Subject to the terms and conditions of this License, each Contributor hereby grants to You a perpetual, worldwide, non-exclusive, no-charge, royalty-free, irrevocable copyright license to reproduce, prepare Derivative Works of, publicly display, publicly perform, sublicense, and distribute the Work and such Derivative Works in Source or Object form.

3. Grant of Patent License. Subject to the terms and conditions of this License, each Contributor hereby grants to You a perpetual, worldwide, non-exclusive, no-charge, royalty-free, irrevocable (except as stated in this section) patent license to make, have made, use, offer to sell, sell, import, and otherwise transfer the Work, where such license applies only to those patent claims licensable by such Contributor that are necessarily infringed by their Contribution(s) alone or by combination of their Contribution(s)

# 本機で使われるソフトウェアライセンス情報 (つづき)

with the Work to which such Contribution(s) was submitted. If You institute patent litigation against any entity (including a cross-claim or counterclaim in a lawsuit) alleging that the Work or a Contribution incorporated within the Work constitutes direct or contributory patent infringement, then any patent licenses granted to You under this License for that Work shall terminate as of the date such litigation is filed.

4. Redistribution. You may reproduce and distribute copies of the Work or Derivative Works thereof in any medium, with or without modifications, and in Source or Object form, provided that You meet the following conditions:

- You must give any other recipients of the Work or Derivative Works a copy of this License; and
- You must cause any modified files to carry prominent notices stating that You changed the files; and
- You must retain, in the Source form of any Derivative Works that You distribute, all copyright, patent, trademark, and attribution notices from the Source form of the Work, excluding those notices that do not pertain to any part of the Derivative Works; and
- If the Work includes a "NOTICE" text file as part of its distribution, then any Derivative Works that You distribute must include a readable copy of the attribution notices contained within such NOTICE file, excluding those notices that do not pertain to any part of the Derivative Works, in at least one of the following places: within a NOTICE text file distributed as part of the Derivative Works; within the Source form or documentation, if provided along with the Derivative Works; or, within a display generated by the Derivative Works, if and wherever such third-party notices normally appear. The contents of the NOTICE file are for informational purposes only and do not modify the License. You may add Your own attribution notices within Derivative Works that You distribute, alongside or as an addendum to the NOTICE text from the Work, provided that such additional attribution notices cannot be construed as modifying the License.

You may add Your own copyright statement to Your modifications and may provide additional or different license terms and conditions for use, reproduction, or distribution of Your modifications, or for any such Derivative Works as a whole, provided Your use, reproduction, and distribution of the Work otherwise complies with the conditions stated in this License.

- Submission of Contributions. Unless You explicitly state otherwise, any Contribution intentionally submitted for inclusion in the Work by You to the Licensor shall be under the terms and conditions of this License, without any additional terms or conditions. Notwithstanding the above, nothing herein shall supersede or modify the terms of any separate license agreement you may have executed with Licensor regarding such Contributions.
- Trademarks. This License does not grant permission to use the trade names, trademarks, service marks, or product names of the Licensor, except as required for reasonable and customary use in describing the origin of the Work and reproducing the content of the NOTICE file.
- Disclaimer of Warranty. Unless required by applicable law or agreed to in writing, Licensor provides the Work (and each Contributor provides its Contribution) on an "AS IS" BASIS, WITHOUT WARRANTIES OR CONDITIONS OF ANY KIND, either express or implied, including, without limitation, any warranties or conditions of TITLE, NON-INFRINGEMENT, MERCHANTABILITY, or FITNESS FOR A PARTICULAR PURPOSE. You are solely responsible for determining the appropriateness of using or redistributing the Work and assume any risks associated with Your exercise of permissions under this License.
- Limitation of Liability. In no event and under no legal theory, whether in tort (including negligence), contract, or otherwise, unless required by applicable law (such as deliberate and grossly negligent acts) or agreed to in writing, shall any Contributor be liable to You for damages, including any direct, indirect, special, incidental, or consequential damages of any character arising as a result of this License or out of the use or inability to use the Work (including but not limited to damages for loss of goodwill, work stoppage, computer failure or malfunction, or any and all other commercial damages or losses), even if such Contributor has been advised of the possibility of such damages.
- Accepting Warranty or Additional Liability. While redistributing the Work or Derivative Works thereof, You may choose to offer, and charge a fee for, acceptance of support, warranty, indemnity, or other liability obligations and/or rights consistent with this License. However, in accepting such obligations, You may act only on Your own behalf and on Your sole responsibility, not on behalf of any other Contributor, and only if You agree to indemnify, defend, and hold each Contributor harmless for any liability incurred by, or claims asserted against, such Contributor by reason of your accepting any such warranty or additional liability.

END OF TERMS AND CONDITIONS

APPENDIX: How to apply the Apache License to your work.

To apply the Apache License to your work, attach the following boilerplate notice, with the fields enclosed by brackets [ ] replaced with your own identifying information. (Don't include the brackets!) The text should be enclosed in the appropriate comment syntax for the file format. We also recommend that a file or class name and description of purpose be included on the same "printed page" as the copyright notice for easier identification within third-party archives.

Copyright 2011 Google Inc. All Rights Reserved.

Licensed under the Apache License, Version 2.0 (the "License"); you may not use this file except in compliance with the License. You may obtain a copy of the License at

<http://www.apache.org/licenses/LICENSE-2.0>

Unless required by applicable law or agreed to in writing, software distributed under the License is distributed on an "AS IS" BASIS, WITHOUT WARRANTIES OR CONDITIONS OF ANY KIND, either express or implied. See the License for the specific language governing permissions and limitations under the License.

Copyright 2011, Google Inc.  
All rights reserved.

Redistribution and use in source and binary forms, with or without modification, are permitted provided that the following conditions are met:

- \* Redistributions of source code must retain the above copyright notice, this list of conditions and the following disclaimer.
- \* Redistributions in binary form must reproduce the above copyright notice, this list of conditions and the following disclaimer in the documentation and/or other materials provided with the distribution.

\* Neither the name of Google Inc. nor the names of its contributors may be used to endorse or promote products derived from this software without specific prior written permission.

THIS SOFTWARE IS PROVIDED BY THE COPYRIGHT HOLDERS AND CONTRIBUTORS "AS IS" AND ANY EXPRESS OR IMPLIED WARRANTIES, INCLUDING, BUT NOT LIMITED TO, THE IMPLIED WARRANTIES OF MERCHANTABILITY AND FITNESS FOR A PARTICULAR PURPOSE ARE DISCLAIMED. IN NO EVENT SHALL THE COPYRIGHT OWNER OR CONTRIBUTORS BE LIABLE FOR ANY DIRECT, INDIRECT, INCIDENTAL, SPECIAL, EXEMPLARY, OR CONSEQUENTIAL DAMAGES (INCLUDING, BUT NOT LIMITED TO, PROCUREMENT OF SUBSTITUTE GOODS OR SERVICES; LOSS OF USE, DATA, OR PROFITS; OR BUSINESS INTERRUPTION) HOWEVER CAUSED AND ON ANY THEORY OF LIABILITY, WHETHER IN CONTRACT, STRICT LIABILITY, OR TORT (INCLUDING NEGLIGENCE OR OTHERWISE) ARISING IN ANY WAY OUT OF THE USE OF THIS SOFTWARE, EVEN IF ADVISED OF THE POSSIBILITY OF SUCH DAMAGE.

The author disclaims copyright to this source code. In place of a legal notice, here is a blessing:

May you do good and not evil.  
May you find forgiveness for yourself and forgive others.  
May you share freely, never taking more than you give.

Copyright (c) 2010, The WebM Project authors. All rights reserved.

Redistribution and use in source and binary forms, with or without modification, are permitted provided that the following conditions are met:

- \* Redistributions of source code must retain the above copyright notice, this list of conditions and the following disclaimer.

- \* Redistributions in binary form must reproduce the above copyright notice, this list of conditions and the following disclaimer in the documentation and/or other materials provided with the distribution.

\* Neither the name of Google, nor the WebM Project, nor the names of its contributors may be used to endorse or promote products derived from this software without specific prior written permission.

THIS SOFTWARE IS PROVIDED BY THE COPYRIGHT HOLDERS AND CONTRIBUTORS "AS IS" AND ANY EXPRESS OR IMPLIED WARRANTIES, INCLUDING, BUT NOT LIMITED TO, THE IMPLIED WARRANTIES OF MERCHANTABILITY AND FITNESS FOR A PARTICULAR PURPOSE ARE DISCLAIMED. IN NO EVENT SHALL THE COPYRIGHT HOLDER OR CONTRIBUTORS BE LIABLE FOR ANY DIRECT, INDIRECT, INCIDENTAL, SPECIAL, EXEMPLARY, OR CONSEQUENTIAL DAMAGES (INCLUDING, BUT NOT LIMITED TO, PROCUREMENT OF SUBSTITUTE GOODS OR SERVICES; LOSS OF USE, DATA, OR PROFITS; OR BUSINESS INTERRUPTION) HOWEVER CAUSED AND ON ANY THEORY OF LIABILITY, WHETHER IN CONTRACT, STRICT LIABILITY, OR TORT (INCLUDING NEGLIGENCE OR OTHERWISE) ARISING IN ANY WAY OUT OF THE USE OF THIS SOFTWARE, EVEN IF ADVISED OF THE POSSIBILITY OF SUCH DAMAGE.

Copyright (c) 2010, Google Inc. All rights reserved.

Redistribution and use in source and binary forms, with or without modification, are permitted provided that the following conditions are met:

- \* Redistributions of source code must retain the above copyright notice, this list of conditions and the following disclaimer.

- \* Redistributions in binary form must reproduce the above copyright notice, this list of conditions and the following disclaimer in the documentation and/or other materials provided with the distribution.

\* Neither the name of Google nor the names of its contributors may be used to endorse or promote products derived from this software without specific prior written permission.

THIS SOFTWARE IS PROVIDED BY THE COPYRIGHT HOLDERS AND CONTRIBUTORS "AS IS" AND ANY EXPRESS OR IMPLIED WARRANTIES, INCLUDING, BUT NOT LIMITED TO, THE IMPLIED WARRANTIES OF MERCHANTABILITY AND FITNESS FOR A PARTICULAR PURPOSE ARE DISCLAIMED. IN NO EVENT SHALL THE COPYRIGHT HOLDER OR CONTRIBUTORS BE LIABLE FOR ANY DIRECT, INDIRECT, INCIDENTAL, SPECIAL, EXEMPLARY, OR CONSEQUENTIAL DAMAGES (INCLUDING, BUT NOT LIMITED TO, PROCUREMENT OF SUBSTITUTE GOODS OR SERVICES; LOSS OF USE, DATA, OR PROFITS; OR BUSINESS INTERRUPTION) HOWEVER CAUSED AND ON ANY THEORY OF LIABILITY, WHETHER IN CONTRACT, STRICT LIABILITY, OR TORT (INCLUDING NEGLIGENCE OR OTHERWISE) ARISING IN ANY WAY OUT OF THE USE OF THIS SOFTWARE, EVEN IF ADVISED OF THE POSSIBILITY OF SUCH DAMAGE.

Copyright (c) 2010, Google Inc. All rights reserved.

Redistribution and use in source and binary forms, with or without modification, are permitted provided that the following conditions are met:

- \* Redistributions of source code must retain the above copyright notice, this list of conditions and the following disclaimer.

- \* Redistributions in binary form must reproduce the above copyright notice, this list of conditions and the following disclaimer in the documentation and/or other materials provided with the distribution.

\* Neither the name of Google nor the names of its contributors may be used to endorse or promote products derived from this software without specific prior written permission.

THIS SOFTWARE IS PROVIDED BY THE COPYRIGHT HOLDERS AND CONTRIBUTORS "AS IS" AND ANY EXPRESS OR IMPLIED WARRANTIES, INCLUDING, BUT NOT LIMITED TO, THE IMPLIED WARRANTIES OF MERCHANTABILITY AND FITNESS FOR A PARTICULAR PURPOSE ARE DISCLAIMED. IN NO EVENT SHALL THE COPYRIGHT HOLDER OR CONTRIBUTORS BE LIABLE FOR ANY DIRECT, INDIRECT, INCIDENTAL, SPECIAL, EXEMPLARY, OR CONSEQUENTIAL DAMAGES (INCLUDING, BUT NOT LIMITED TO, PROCUREMENT OF SUBSTITUTE GOODS OR SERVICES; LOSS OF USE, DATA, OR PROFITS; OR BUSINESS INTERRUPTION) HOWEVER CAUSED AND ON ANY THEORY OF LIABILITY, WHETHER IN CONTRACT, STRICT LIABILITY, OR TORT (INCLUDING NEGLIGENCE OR OTHERWISE) ARISING IN ANY WAY OUT OF THE USE OF THIS SOFTWARE, EVEN IF ADVISED OF THE POSSIBILITY OF SUCH DAMAGE.

Additional IP Rights Grant (Patents)

"These implementations" means the copyrightable works that implement the WebM codecs distributed by Google as part of the WebM Project.

Google hereby grants to you a perpetual, worldwide, non-exclusive, no-charge, royalty-free, irrevocable (except as stated in this section) patent license to make, have made, use, offer to sell, sell, import, transfer, and otherwise run, modify and propagate the contents of these implementations of WebM, where such license applies only to those patent claims, both currently owned by Google and acquired in the future, licensable by Google that are necessarily infringed by these implementations of WebM. This grant does not include claims

that would be infringed only as a consequence of further modification of these implementations. If you or your agent or exclusive licensee institute or order or agree to the institution of patent litigation or any other patent enforcement activity against any entity (including a cross-claim or counterclaim in a lawsuit) alleging that any of these implementations of WebM or any code incorporated within any of these implementations of WebM constitute direct or contributory patent infringement, or inducement of patent infringement, then any patent rights granted to you under this License for these implementations of WebM shall terminate as of the date such litigation is filed.

Apache License  
Version 2.0, January 2004  
<http://www.apache.org/licenses/>

## TERMS AND CONDITIONS FOR USE, REPRODUCTION, AND DISTRIBUTION

### 1. Definitions.

"License" shall mean the terms and conditions for use, reproduction, and distribution as defined by Sections 1 through 9 of this document.

"Licensor" shall mean the copyright owner or entity authorized by the copyright owner that is granting the License.

"Legal Entity" shall mean the union of the acting entity and all other entities that control, are controlled by, or are under common control with that entity. For the purposes of this definition, "control" means (i) the power, direct or indirect, to cause the direction or management of such entity, whether by contract or otherwise, or (ii) ownership of fifty percent (50%) or more of the outstanding shares, or (iii) beneficial ownership of such entity.

"You" (or "Your") shall mean an individual or Legal Entity exercising permissions granted by this License.

"Source" form shall mean the preferred form for making modifications, including but not limited to software source code, documentation source, and configuration files.

"Object" form shall mean any form resulting from mechanical transformation or translation of a Source form, including but not limited to compiled object code, generated documentation, and conversions to other media types.

"Work" shall mean the work of authorship, whether in Source or Object form, made available under the License, as indicated by a copyright notice that is included in or attached to the work (an example is provided in the Appendix below).

"Derivative Works" shall mean any work, whether in Source or Object form, that is based on (or derived from) the Work and for which the editorial revisions, annotations, elaborations, or other modifications represent, as a whole, an original work of authorship. For the purposes of this License, Derivative Works shall not include works that remain separable from, or merely link (or bind by name) to the interfaces of, the Work and Derivative Works thereof.

"Contribution" shall mean any work of authorship, including the original version of the Work and any modifications or additions to that Work or Derivative Works thereof, that is intentionally submitted to Licensor for inclusion in the Work by the copyright owner or by an individual or Legal Entity authorized to submit on behalf of the copyright owner. For the purposes of this definition, "submitted" means any form of electronic, verbal, or written communication sent to the Licensor or its representatives, including but not limited to communication on electronic mailing lists, source code control systems, and issue tracking systems that are managed by, or on behalf of, the Licensor for the purpose of discussing and improving the Work, but excluding communication that is conspicuously marked or otherwise designated in writing by the copyright owner as "Not a Contribution."

"Contributor" shall mean Licensor and any individual or Legal Entity on behalf of whom a Contribution has been received by Licensor and subsequently incorporated within the Work.

2. Grant of Copyright License. Subject to the terms and conditions of this License, each Contributor hereby grants to You a perpetual, worldwide, non-exclusive, no-charge, royalty-free, irrevocable copyright license to reproduce, prepare Derivative Works of, publicly display, publicly perform, sublicense, and distribute the Work and such Derivative Works in Source or Object form.

3. Grant of Patent License. Subject to the terms and conditions of this License, each Contributor hereby grants to You a perpetual, worldwide, non-exclusive, no-charge, royalty-free, irrevocable (except as stated in this section) patent license to make, have made, use, offer to sell, sell, import, and otherwise transfer the Work, where such license applies only to those patent claims licensable by such Contributor that are necessarily infringed by their Contribution(s) alone or by combination of their Contribution(s) with the Work to which such Contribution(s) was submitted. If You institute patent litigation against any entity (including a cross-claim or counterclaim in a lawsuit) alleging that the Work or a Contribution incorporated within the Work constitutes direct or contributory patent infringement, then any patent licenses granted to You under this License for that Work shall terminate as of the date such litigation is filed.

4. Redistribution. You may reproduce and distribute copies of the Work or Derivative Works thereof in any medium, with or without modifications, and in Source or Object form, provided that You meet the following conditions:

- You must give any other recipients of the Work or Derivative Works a copy of this License; and
- You must cause any modified files to carry prominent notices stating that You changed the files; and
- You must retain, in the Source form of any Derivative Works that You distribute, all copyright, patent, trademark, and attribution notices from the Source form of the Work, excluding those notices that do not pertain to any part of the Derivative Works; and
- If the Work includes a "NOTICE" text file as part of its distribution, then any Derivative Works that You distribute must include a readable copy of the attribution notices contained within such NOTICE file, excluding those notices that do not pertain to any part of the Derivative Works, in at least one of the following places: within a NOTICE text file distributed as part of the Derivative Works; within the Source form or documentation, if provided along with the Derivative Works; or, within a display generated by the Derivative Works, if and wherever such third-party notices normally appear. The contents of the NOTICE file are for informational purposes only and do not modify the License. You may add Your own attribution notices within Derivative Works that You distribute, alongside or as an addendum to the NOTICE text from the Work, provided that such additional attribution notices cannot be construed as modifying the License.

You may add Your own copyright statement to Your modifications and may provide additional or different license terms and conditions

for use, reproduction, or distribution of Your modifications, or for any such Derivative Works as a whole, provided Your use, reproduction, and distribution of the Work otherwise complies with the conditions stated in this License.

5. Submission of Contributions. Unless You explicitly state otherwise, any Contribution intentionally submitted for inclusion in the Work by You to the Licensor shall be under the terms and conditions of this License, without any additional terms or conditions. Notwithstanding the above, nothing herein shall supersede or modify the terms of any separate license agreement you may have executed with Licensor regarding such Contributions.

6. Trademarks. This License does not grant permission to use the trade names, trademarks, service marks, or product names of the Licensor, except as required for reasonable and customary use in describing the origin of the Work and reproducing the content of the NOTICE file.

7. Disclaimer of Warranty. Unless required by applicable law or agreed to in writing, Licensor provides the Work (and each Contributor provides its Contributions) on an "AS IS" BASIS, WITHOUT WARRANTIES OR CONDITIONS OF ANY KIND, either express or implied, including, without limitation, any warranties or conditions of TITLE, NON-INFRINGEMENT, MERCHANTABILITY, or FITNESS FOR A PARTICULAR PURPOSE. You are solely responsible for determining the appropriateness of using or redistributing the Work and assume any risks associated with Your exercise of permissions under this License.

8. Limitation of Liability. In no event and under no legal theory, whether in tort (including negligence), contract, or otherwise, unless required by applicable law (such as deliberate and grossly negligent acts) or agreed to in writing, shall any Contributor be liable to You for damages, including any direct, indirect, special, incidental, or consequential damages of any character arising as a result of this License or out of the use or inability to use the Work (including but not limited to damages for loss of goodwill, work stoppage, computer failure or malfunction, or any and all other commercial damages or losses), even if such Contributor has been advised of the possibility of such damages.

9. Accepting Warranty or Additional Liability. While redistributing the Work or Derivative Works thereof, you may choose to offer, and charge a fee for, acceptance of support, warranty, indemnity, or other liability obligations and/or rights consistent with this License. However, in accepting such obligations, You may act only on Your own behalf and on Your sole responsibility, not on behalf of any other Contributor, and only if You agree to indemnify, defend, and hold each Contributor harmless for any liability incurred by, or claims asserted against, such Contributor by reason of your accepting any such warranty or additional liability.

## END OF TERMS AND CONDITIONS

### APPENDIX: How to apply the Apache License to your work.

To apply the Apache License to your work, attach the following boilerplate notice, with the fields enclosed by brackets [ ] replaced with your own identifying information. (Don't include the brackets!) The text should be enclosed in the appropriate comment syntax for the file format. We also recommend that a file or class name and description of purpose be included on the same "printed page" as the copyright notice for easier identification within third-party archives.

Copyright [yyyy] [name of copyright owner]

Licensed under the Apache License, Version 2.0 (the "License"); you may not use this file except in compliance with the License. You may obtain a copy of the License at

<http://www.apache.org/licenses/LICENSE-2.0>

Unless required by applicable law or agreed to in writing, software distributed under the License is distributed on an "AS IS" BASIS, WITHOUT WARRANTIES OR CONDITIONS OF ANY KIND, either express or implied. See the License for the specific language governing permissions and limitations under the License.

Except where otherwise noted in the source code (e.g. the files hash.c, list.c and the trio files, which are covered by a similar licence but with different Copyright notices) all the files are:

Copyright (C) 1998-2012 Daniel Veillard. All Rights Reserved.

Permission is hereby granted, free of charge, to any person obtaining a copy of this software and associated documentation files (the "Software"), to deal in the Software without restriction, including without limitation the rights to use, copy, modify, merge, publish, distribute, sublicense, and/or sell copies of the Software, and to permit persons to whom the Software is furnished to do so, subject to the following conditions:

The above copyright notice and this permission notice shall be included in all copies or substantial portions of the Software.

THE SOFTWARE IS PROVIDED "AS IS", WITHOUT WARRANTY OF ANY KIND, EXPRESS OR IMPLIED, INCLUDING BUT NOT LIMITED TO THE WARRANTIES OF MERCHANTABILITY, FITNESS FOR A PARTICULAR PURPOSE AND NONINFRINGEMENT. IN NO EVENT SHALL THE AUTHORS OR COPYRIGHT HOLDERS BE LIABLE FOR ANY CLAIM, DAMAGES OR OTHER LIABILITY, WHETHER IN AN ACTION OF CONTRACT, TORT OR OTHERWISE, ARISING FROM, OUT OF OR IN CONNECTION WITH THE SOFTWARE OR THE USE OR OTHER DEALINGS IN THE SOFTWARE.

### License for libxslt except libxslt

Copyright (C) 2001-2002 Daniel Veillard. All Rights Reserved.

Permission is hereby granted, free of charge, to any person obtaining a copy of this software and associated documentation files (the "Software"), to deal in the Software without restriction, including without limitation the rights to use, copy, modify, merge, publish, distribute, sublicense, and/or sell copies of the Software, and to permit persons to whom the Software is furnished to do so, subject to the following conditions:

The above copyright notice and this permission notice shall be included in all copies or substantial portions of the Software.

THE SOFTWARE IS PROVIDED "AS IS", WITHOUT WARRANTY OF ANY KIND, EXPRESS OR IMPLIED, INCLUDING BUT NOT LIMITED TO THE WARRANTIES OF MERCHANTABILITY, FITNESS FOR A PARTICULAR PURPOSE AND NONINFRINGEMENT. IN NO EVENT SHALL THE DANIEL VAILLARD BE LIABLE FOR ANY CLAIM, DAMAGES OR OTHER LIABILITY, WHETHER IN AN ACTION OF CONTRACT, TORT OR OTHERWISE, ARISING FROM, OUT OF OR IN CONNECTION WITH THE SOFTWARE OR THE USE OR OTHER DEALINGS IN THE SOFTWARE.

Except as contained in this notice, the name of Daniel Veillard shall not be used in advertising or otherwise to promote the sale, use or other dealings in this Software without prior written authorization from him.

### License for libxslt

Copyright (C) 2001-2002 Thomas Broyer, Charlie Bozeman and Daniel Veillard. All Rights Reserved.

# 本機で使われるソフトウェアライセンス情報 (つづき)

Permission is hereby granted, free of charge, to any person obtaining a copy of this software and associated documentation files (the "Software"), to deal in the Software without restriction, including without limitation the rights to use, copy, modify, merge, publish, distribute, sublicense, and/or sell copies of the Software, and to permit persons to whom the Software is furnished to do so, subject to the following conditions:

The above copyright notice and this permission notice shall be included in all copies or substantial portions of the Software.

THE SOFTWARE IS PROVIDED "AS IS", WITHOUT WARRANTY OF ANY KIND, EXPRESS OR IMPLIED, INCLUDING BUT NOT LIMITED TO THE WARRANTIES OF MERCHANTABILITY, FITNESS FOR A PARTICULAR PURPOSE AND NONINFRINGEMENT. IN NO EVENT SHALL THE AUTHORS BE LIABLE FOR ANY CLAIM, DAMAGES OR OTHER LIABILITY, WHETHER IN AN ACTION OF CONTRACT, TORT OR OTHERWISE, ARISING FROM, OUT OF OR IN CONNECTION WITH THE SOFTWARE OR THE USE OR OTHER DEALINGS IN THE SOFTWARE.

Except as contained in this notice, the name of the authors shall not be used in advertising or otherwise to promote the sale, use or other dealings in this Software without prior written authorization from him.

OSS Copyright of NetFront Browser NX v3.0

This product may include derivative work of all or part of Webkit core Revision 149069 which is governed by the following license terms and conditions:

Copyright (C) 2005, 2006, 2007, 2008, 2009 Apple Inc. All rights reserved.

Redistribution and use in source and binary forms, with or without modification, are permitted provided that the following conditions are met:

1. Redistributions of source code must retain the above copyright notice, this list of conditions and the following disclaimer.
2. Redistributions in binary form must reproduce the above copyright notice, this list of conditions and the following disclaimer in the documentation and/or other materials provided with the distribution.

THIS SOFTWARE IS PROVIDED BY APPLE INC. AND ITS CONTRIBUTORS "AS IS" AND ANY EXPRESS OR IMPLIED WARRANTIES, INCLUDING, BUT NOT LIMITED TO, THE IMPLIED WARRANTIES OF MERCHANTABILITY AND FITNESS FOR A PARTICULAR PURPOSE ARE DISCLAIMED. IN NO EVENT SHALL APPLE INC. OR ITS CONTRIBUTORS BE LIABLE FOR ANY DIRECT, INDIRECT, INCIDENTAL, SPECIAL, EXEMPLARY, OR CONSEQUENTIAL DAMAGES (INCLUDING, BUT NOT LIMITED TO, PROCUREMENT OF SUBSTITUTE GOODS OR SERVICES; LOSS OF USE, DATA, OR PROFITS; OR BUSINESS INTERRUPTION) HOWEVER CAUSED AND ON ANY THEORY OF LIABILITY, WHETHER IN CONTRACT, STRICT LIABILITY, OR TORT (INCLUDING NEGLIGENCE OR OTHERWISE) ARISING IN ANY WAY OUT OF THE USE OF THIS SOFTWARE, EVEN IF ADVISED OF THE POSSIBILITY OF SUCH DAMAGE.

## GNU LIBRARY GENERAL PUBLIC LICENSE

Version 2, June 1991

Copyright (C) 1991 Free Software Foundation, Inc.  
51 Franklin St, Fifth Floor, Boston, MA 02110-1301, USA  
Everyone is permitted to copy and distribute verbatim copies of this license document, but changing it is not allowed.

[This is the first released version of the library GPL. It is numbered 2 because it goes with version 2 of the ordinary GPL.]

### Preamble

The licenses for most software are designed to take away your freedom to share and change it. By contrast, the GNU General Public Licenses are intended to guarantee your freedom to share and change free software--to make sure the software is free for all its users.

This license, the Library General Public License, applies to some specially designated Free Software Foundation software, and to any other libraries whose authors decide to use it. You can use it for your libraries, too.

When we speak of free software, we are referring to freedom, not price. Our General Public Licenses are designed to make sure that you have the freedom to distribute copies of free software (and charge for this service if you wish), that you receive source code or can get it if you want it, that you can change the software or use pieces of it in new free programs; and that you know you can do these things.

To protect your rights, we need to make restrictions that forbid anyone to deny you these rights or to ask you to surrender the rights. These restrictions translate to certain responsibilities for you if you distribute copies of the library, or if you modify it.

For example, if you distribute copies of the library, whether gratis or for a fee, you must give the recipients all the rights that we gave you. You must make sure that they, too, receive or can get the source code. If you link a program with the library, you must provide complete object files to the recipients so that they can relink them with the library, after making changes to the library and recompiling it. And you must show them these terms so they know their rights.

Our method of protecting your rights has two steps: (1) copyright the library, and (2) offer you this license which gives you legal permission to copy, distribute and/or modify the library.

Also, for each distributor's protection, we want to make certain that everyone understands that there is no warranty for this free library. If the library is modified by someone else and passed on, we want its recipients to know that what they have is not the original version, so that any problems introduced by others will not reflect on the original authors' reputations.

Finally, any free program is threatened constantly by software patents. We wish to avoid the danger that companies distributing free software will individually obtain patent licenses, thus in effect transforming the program into proprietary software. To prevent this, we have made it clear that any patent must be licensed for everyone's free use or not licensed at all.

Most GNU software, including some libraries, is covered by the ordinary GNU General Public License, which was designed for utility programs. This license, the GNU Library General Public License, applies to certain designated libraries. This license is quite different from the ordinary one; be sure to read it in full, and don't assume that anything in it is the same as in the ordinary license.

The reason we have a separate public license for some libraries is that they blur the distinction we usually make between modifying or adding to a program and simply using it. Linking a program with a library, without changing the library, is in some sense simply using the library, and is analogous to running a utility program or application program. However, in a textual and legal sense, the linked executable is a combined work, a derivative of the original library, and the ordinary General Public License treats it as such.

Because of this blurred distinction, using the ordinary General Public License for libraries did not effectively promote software sharing, because most developers did not use the library. We concluded that weaker conditions might promote sharing better.

However, unrestricted linking of non-free programs would deprive the users of those programs of all benefit from the free status of the libraries themselves.

This Library General Public License is intended to permit developers of non-free programs to use free libraries, while preserving your freedom as a user of such programs to change the free libraries that are incorporated in them. We have not seen how to achieve this as regards changes in header files, but we have achieved it as regards changes in the actual functions of the library. The hope is that this will lead to faster development of free libraries.

The precise terms and conditions for copying, distribution and modification follow. Pay close attention to the difference between a "work based on the library" and a "work that uses the library". The former contains code derived from the library, while the latter only works together with the library.

Note that it is possible for a library to be covered by the ordinary General Public License rather than by this special one.

0. This License Agreement applies to any software library which contains a notice placed by the copyright holder or other authorized party saying it may be distributed under the terms of this Library General Public License (also called "this License"). Each licensee is addressed as "you".

A "library" means a collection of software functions and/or data prepared so as to be conveniently linked with application programs (which use some of those functions and data) to form executables.

The "Library", below, refers to any such software library or work which has been distributed under these terms. A "work based on the Library" means either the Library or any derivative work under copyright law: that is to say, a work containing the Library or a portion of it, either verbatim or with modifications and/or translated straightforwardly into another language. (Hereinafter, translation is included without limitation in the term "modification".)

"Source code" for a work means the preferred form of the work for making modifications to it. For a library, complete source code means all the source code for all modules it contains, plus any associated interface definition files, plus the scripts used to control compilation and installation of the library.

Activities other than copying, distribution and modification are not covered by this license; they are outside its scope. The act of running a program using the Library is not restricted, and output from such a program is covered only if its contents constitute a work based on the Library (independent of the use of the Library in a tool for writing it). Whether that is true depends on what the Library does and what the program that uses the Library does.

1. You may copy and distribute verbatim copies of the Library's complete source code as you receive it, in any medium, provided that you conspicuously and appropriately publish on each copy an appropriate copyright notice and disclaimer of warranty; keep intact all the notices that refer to this License and to the absence of any warranty; and distribute a copy of this License along with the Library.

You may charge a fee for the physical act of transferring a copy, and you may at your option offer warranty protection in exchange for a fee.

2. You may modify your copy or copies of the Library or any portion of it, thus forming a work based on the Library, and copy and distribute such modifications or work under the terms of Section 1 above, provided that you also meet all of these conditions:

- a) The modified work must itself be a software library.
- b) You must cause the files modified to carry prominent notices stating that you changed the files and the date of any change.
- c) You must cause the whole of the work to be licensed at no charge to all third parties under the terms of this License.
- d) If a facility in the modified Library refers to a function or a table of data to be supplied by an application program that uses the facility, other than as an argument passed when the facility is invoked, then you must make a good faith effort to ensure that, in the event an application does not supply such function or table, the facility still operates, and performs whatever part of its purpose remains meaningful. (For example, a function in a library to compute square roots has a purpose that is entirely well-defined independent of the application. Therefore, Subsection 2d requires that any application-supplied function or table used by this function must be optional: if the application does not supply it, the square root function must still compute square roots.)

These requirements apply to the modified work as a whole. If identifiable sections of that work are not derived from the Library, and can be reasonably considered independent and separate works in themselves, then this License, and its terms, do not apply to those sections when you distribute them as separate works. But when you distribute the same sections as part of a whole which is a work based on the Library, the distribution of the whole must be on the terms of this License, whose permissions for other licensees extend to the entire whole, and thus to each and every part regardless of who wrote it.

Thus, it is not the intent of this section to claim rights or contest your rights in work not primarily based on the library; the intent is to exercise the right to control the distribution of derivative or collective works based on the Library.

In addition, mere aggregation of another work not based on the Library with the Library (or with a work based on the Library) on a volume of a storage or distribution medium does not bring the other work under the scope of this License.

3. You may opt to apply the terms of the ordinary GNU General Public License instead of this License to a given copy of the Library. To do this, you must alter all the notices that refer to this License, so that they refer to the ordinary GNU General Public License, version 2, instead of to this License. (If a newer version than version 2 of the ordinary GNU General Public License has appeared, then you can specify that version instead if you wish.) Do not make any other change in these notices.

Once this change is made in a given copy, it is irreversible for that copy, so the ordinary GNU General Public License applies to all subsequent copies and derivative works made from that copy.

This option is useful when you wish to copy part of the code of the Library into a program that is not a library.

4. You may copy and distribute the Library (or a portion or derivative of it, under Section 2) in object code or executable form under the terms of Sections 1 and 2 above provided that you accompany it with the complete corresponding machine-readable source code, which must be distributed under the terms of Sections 1 and 2 above on a medium customarily used for software interchange.

If distribution of object code is made by offering access to copy from a designated place, then offering equivalent access to copy the source code from the same place satisfies the requirement to distribute the source code, even though third parties are not compelled to copy the source along with the object code.

5. A program that contains no derivative of any portion of the Library, but is designed to work with the Library by being compiled or linked with it, is called a "work that uses the Library". Such a work, in isolation, is not a derivative work of the Library, and therefore falls outside the scope of this License.

However, linking a "work that uses the Library" with the Library creates an executable that is a derivative of the Library (because it contains portions of the Library), rather than a "work that uses the Library". The executable

is therefore covered by this License. Section 6 states terms for distribution of such executables.

When a "work that uses the Library" uses material from a header file that is part of the Library, the object code for the work may be a derivative work of the Library even though the source code is not. Whether this is true is especially significant if the work can be linked without the Library, or if the work is itself a library. The threshold for this to be true is not precisely defined by law.

If such an object file uses only numerical parameters, data structure layouts and accessors, and small macros and small inline functions (ten lines or less in length), then the use of the object file is unrestricted, regardless of whether it is legally a derivative work. (Executables containing this object code plus portions of the Library will still fall under Section 6.)

Otherwise, if the work is a derivative of the Library, you may distribute the object code for the work under the terms of Section 6. Any executables containing that work also fall under Section 6, whether or not they are linked directly with the Library itself.

6. As an exception to the Sections above, you may also compile or link a "work that uses the Library" with the Library to produce a work containing portions of the Library, and distribute that work under terms of your choice, provided that the terms permit modification of the work for the customer's own use and reverse engineering for debugging such modifications.

You must give prominent notice with each copy of the work that the Library is used in it and that the Library and its use are covered by this License. You must supply a copy of this License. If the work during execution displays copyright notices, you must include the copyright notice for the Library among them, as well as a reference directing the user to the copy of this License. Also, you must do one of these things:

a) Accompany the work with the complete corresponding machine-readable source code for the Library including whatever changes were used in the work (which must be distributed under Sections 1 and 2 above); and, if the work is an executable linked with the Library, with the complete machine-readable "work that uses the Library", as object code and/or source code, so that the user can modify the Library and then relink to produce a modified executable containing the modified Library. (It is understood that the user who changes the contents of definitions files in the Library will not necessarily be able to recompile the application to use the modified definitions.)

b) Accompany the work with a written offer, valid for at least three years, to give the same user the materials specified in Subsection 6a, above, for a charge no more than the cost of performing this distribution.

c) If distribution of the work is made by offering access to copy from a designated place, offer equivalent access to copy the above specified materials from the same place.

d) Verify that the user has already received a copy of these materials or that you have already sent this user a copy.

For an executable, the required form of the "work that uses the Library" must include any data and utility programs needed for reproducing the executable from it. However, as a special exception, the source code distributed need not include anything that is normally distributed (in either source or binary form) with the means (compiler, kernel, and so on) of the operating system on which the executable runs, unless that component itself accompanies the executable.

It may happen that this requirement contradicts the license restrictions of other proprietary libraries that do not normally accompany the operating system. Such a contradiction means you cannot use both them and the Library together in an executable that you distribute.

7. You may place library facilities that are a work based on the Library side-by-side in a single library together with other library facilities not covered by this License, and distribute such a combined library, provided that the separate distribution of the work based on the Library and of the other library facilities is otherwise permitted, and provided that you do these two things:

a) Accompany the combined library with a copy of the same work based on the Library, uncombined with any other library facilities. This must be distributed under the terms of the Sections above.

b) Give prominent notice with the combined library of the fact that part of it is a work based on the Library, and explaining where to find the accompanying uncombined form of the same work.

8. You may not copy, modify, sublicense, link with, or distribute the Library except as expressly provided under this License. Any attempt otherwise to copy, modify, sublicense, link with, or distribute the Library is void, and will automatically terminate your rights under this License. However, parties who have received copies, or rights, from you under this License will not have their licenses terminated so long as such parties remain in full compliance.

9. You are not required to accept this License, since you have not signed it. However, nothing else grants you permission to modify or distribute the Library or its derivative works. These actions are prohibited by law if you do not accept this License. Therefore, by modifying or distributing the Library (or any work based on the Library), you indicate your acceptance of this License to do so, and all its terms and conditions for copying, distributing or modifying the Library or works based on it.

10. Each time you redistribute the Library (or any work based on the Library), the recipient automatically receives a license from the original licensor to copy, distribute, link with or modify the Library subject to these terms and conditions. You may not impose any further restrictions on the recipients' exercise of the rights granted herein. You are not responsible for enforcing compliance by third parties to this License.

11. If, as a consequence of a court judgment or allegation of patent infringement or for any other reason (not limited to patent issues), conditions are imposed on you (whether by court order, agreement or otherwise) that contradict the conditions of this License, they do not excuse you from the conditions of this License. If you cannot distribute so as to satisfy simultaneously your obligations under this License and any other pertinent obligations, then as a consequence you may not distribute the Library at all. For example, if a patent license would not permit royalty-free redistribution of the Library by all those who receive copies directly or indirectly through you, then the only way you could satisfy both it and this License would be to refrain entirely from distribution of the Library.

If any portion of this section is held invalid or unenforceable under any particular circumstance, the balance of the section is intended to apply, and the section as a whole is intended to apply in other circumstances.

It is not the purpose of this section to induce you to infringe any patents or other property right claims or to contest validity of any such claims; this section has the sole purpose of protecting the integrity of the free software distribution system which is implemented by public license practices. Many people have made generous contributions to the wide range of software distributed through that system in reliance on consistent application of that system; it is up to the author/donor to decide if he or she is willing to distribute software through any other system and a licensee cannot impose that choice.

This section is intended to make thoroughly clear what is believed to be a consequence of the rest of this License.

12. If the distribution and/or use of the Library is restricted in certain countries either by patents or by copyrighted interfaces, the original copyright holder who places the Library under this License may add an explicit geographical distribution limitation excluding those countries, so that distribution is permitted only in or among countries not thus excluded. In such

case, this License incorporates the limitation as if written in the body of this License.

13. The Free Software Foundation may publish revised and/or new versions of the Library General Public License from time to time. Such new versions will be similar in spirit to the present version, but may differ in detail to address new problems or concerns.

Each version is given a distinguishing version number. If the Library specifies a version number of this License which applies to it and "any later version", you have the option of following the terms and conditions either of that version or of any later version published by the Free Software Foundation. If the Library does not specify a license version number, you may choose any version ever published by the Free Software Foundation.

14. If you wish to incorporate parts of the Library into other free programs whose distribution conditions are incompatible with these, write to the author to ask for permission. For software which is copyrighted by the Free Software Foundation, write to the Free Software Foundation; we sometimes make exceptions for this. Our decision will be guided by the two goals of preserving the free status of all derivatives of our free software and of promoting the sharing and reuse of software generally.

#### NO WARRANTY

15. BECAUSE THE LIBRARY IS LICENSED FREE OF CHARGE, THERE IS NO WARRANTY FOR THE LIBRARY, TO THE EXTENT PERMITTED BY APPLICABLE LAW. EXCEPT WHEN OTHERWISE STATED IN WRITING THE COPYRIGHT HOLDERS AND/OR OTHER PARTIES PROVIDE THE LIBRARY "AS IS" WITHOUT WARRANTY OF ANY KIND, EITHER EXPRESSED OR IMPLIED, INCLUDING, BUT NOT LIMITED TO, THE IMPLIED WARRANTIES OF MERCHANTABILITY AND FITNESS FOR A PARTICULAR PURPOSE. THE ENTIRE RISK AS TO THE QUALITY AND PERFORMANCE OF THE LIBRARY IS WITH YOU. SHOULD THE LIBRARY PROVE DEFECTIVE, YOU ASSUME THE COST OF ALL NECESSARY SERVICING, REPAIR OR CORRECTION.

16. IN NO EVENT UNLESS REQUIRED BY APPLICABLE LAW OR AGREED TO IN WRITING WILL ANY COPYRIGHT HOLDER, OR ANY OTHER PARTY WHO MAY MODIFY AND/OR REDISTRIBUTE THE LIBRARY AS PERMITTED ABOVE, BE LIABLE TO YOU FOR DAMAGES, INCLUDING ANY GENERAL, SPECIAL, INCIDENTAL OR CONSEQUENTIAL DAMAGES ARISING OUT OF THE USE OR INABILITY TO USE THE LIBRARY (INCLUDING BUT NOT LIMITED TO LOSS OF DATA OR DATA BEING RENDERED INACCURATE OR LOSSES SUSTAINED BY YOU OR THIRD PARTIES OR A FAILURE OF THE LIBRARY TO OPERATE WITH ANY OTHER SOFTWARE), EVEN IF SUCH HOLDER OR OTHER PARTY HAS BEEN ADVISED OF THE POSSIBILITY OF SUCH DAMAGES.

#### END OF TERMS AND CONDITIONS

#### How to Apply These Terms to Your New Libraries

If you develop a new library, and you want it to be of the greatest possible use to the public, we recommend making it free software that everyone can redistribute and change. You can do so by permitting redistribution under these terms (or, alternatively, under the terms of the ordinary General Public License).

To apply these terms, attach the following notices to the library. It is safest to attach them to the start of each source file to most effectively convey the exclusion of warranty; and each file should have at least the "copyright" line and a pointer to where the full notice is found.

one line to give the library's name and an idea of what it does.  
Copyright (C) year name of author

This library is free software; you can redistribute it and/or modify it under the terms of the GNU Library General Public License as published by the Free Software Foundation; either version 2 of the License, or (at your option) any later version.

This library is distributed in the hope that it will be useful, but WITHOUT ANY WARRANTY; without even the implied warranty of MERCHANTABILITY or FITNESS FOR A PARTICULAR PURPOSE. See the GNU Library General Public License for more details.

You should have received a copy of the GNU Library General Public License along with this library; if not, write to the Free Software Foundation, Inc., 51 Franklin St, Fifth Floor, Boston, MA 02110-1301, USA.

Also add information on how to contact you by electronic and paper mail.

You should also get your employer (if you work as a programmer) or your school, if any, to sign a "copyright disclaimer" for the library, if necessary. Here is a sample; alter the names:

Yoyodyne, Inc., hereby disclaims all copyright interest in the library 'Frob' (a library for tweaking knobs) written by James Random Hacker.

signature of Ty Coon, 1 April 1990  
Ty Coon, President of Vice

That's all there is to it!

-----  
BSD License

Copyright (C) 2009 Apple Inc. All rights reserved.

Redistribution and use in source and binary forms, with or without modification, are permitted provided that the following conditions are met:

1. Redistributions of source code must retain the above copyright notice, this list of conditions and the following disclaimer.

2. Redistributions in binary form must reproduce the above copyright notice, this list of conditions and the following disclaimer in the documentation and/or other materials provided with the distribution.

THIS SOFTWARE IS PROVIDED BY APPLE INC. AND ITS CONTRIBUTORS "AS IS" AND ANY EXPRESS OR IMPLIED WARRANTIES, INCLUDING, BUT NOT LIMITED TO, THE IMPLIED WARRANTIES OF MERCHANTABILITY AND FITNESS FOR A PARTICULAR PURPOSE ARE DISCLAIMED. IN NO EVENT SHALL APPLE INC. OR ITS CONTRIBUTORS BE LIABLE FOR ANY DIRECT, INDIRECT, SPECIAL, EXEMPLARY, OR CONSEQUENTIAL DAMAGES (INCLUDING, BUT NOT LIMITED TO, PROCUREMENT OF SUBSTITUTE GOODS OR SERVICES; LOSS OF USE, DATA, OR PROFITS; OR BUSINESS INTERRUPTION) HOWEVER CAUSED AND ON ANY THEORY OF LIABILITY, WHETHER IN CONTRACT, STRICT LIABILITY, OR TORT (INCLUDING NEGLIGENCE OR OTHERWISE) ARISING IN ANY WAY OUT OF THE USE OF THIS SOFTWARE, EVEN IF ADVISED OF THE POSSIBILITY OF SUCH DAMAGE.

=====  
This product may include derivative work of all or part of

FastMalloc.cpp

revision 87411 which is governed by the following license terms and conditions:

-----  
Copyright (c) 2005, 2007, Google Inc. All rights reserved.  
Copyright (C) 2005, 2006, 2007, 2008, 2009, 2011 Apple Inc. All rights reserved.

Redistribution and use in source and binary forms, with or without modification, are permitted provided that the following conditions are met:

- \* Redistributions of source code must retain the above copyright notice, this list of conditions and the following disclaimer.
- \* Redistributions in binary form must reproduce the above

# 本機で使われるソフトウェアライセンス情報 (つづき)

copyright notice, this list of conditions and the following disclaimer in the documentation and/or other materials provided with the distribution.

\* Neither the name of Google Inc. nor the names of its contributors may be used to endorse or promote products derived from this software without specific prior written permission.

THIS SOFTWARE IS PROVIDED BY THE COPYRIGHT HOLDERS AND CONTRIBUTORS "AS IS" AND ANY EXPRESS OR IMPLIED WARRANTIES, INCLUDING, BUT NOT LIMITED TO, THE IMPLIED WARRANTIES OF MERCHANTABILITY AND FITNESS FOR A PARTICULAR PURPOSE ARE DISCLAIMED. IN NO EVENT SHALL THE COPYRIGHT OWNER OR CONTRIBUTORS BE LIABLE FOR ANY DIRECT, INDIRECT, INCIDENTAL, SPECIAL, EXEMPLARY, OR CONSEQUENTIAL DAMAGES (INCLUDING, BUT NOT LIMITED TO, PROCUREMENT OF SUBSTITUTE GOODS OR SERVICES; LOSS OF USE, DATA, OR PROFITS; OR BUSINESS INTERRUPTION) HOWEVER CAUSED AND ON ANY THEORY OF LIABILITY, WHETHER IN CONTRACT, STRICT LIABILITY, OR TORT (INCLUDING NEGLIGENCE OR OTHERWISE) ARISING IN ANY WAY OUT OF THE USE OF THIS SOFTWARE, EVEN IF ADVISED OF THE POSSIBILITY OF SUCH DAMAGE.

=====

This product may include derivative work of all or part of

libpng version 1.5.19

which is governed by the following license terms and conditions:

-----

This copy of the libpng notices is provided for your convenience. In case of any discrepancy between this copy and the notices in the file png.h that is included in the libpng distribution, the latter shall prevail.

COPYRIGHT NOTICE, DISCLAIMER, and LICENSE:

If you modify libpng you may insert additional notices immediately following this sentence.

This code is released under the libpng license.

libpng versions 1.2.6, August 15, 2004, through 1.5.19, August 21, 2014, are Copyright (c) 2004, 2006-2014 Glenn Randers-Pehrson, and are distributed according to the same disclaimer and license as libpng-1.2.5 with the following individual added to the list of Contributing Authors

Cosmin Truta

libpng versions 1.0.7, July 1, 2000, through 1.2.5 - October 3, 2002, are Copyright (c) 2000-2002 Glenn Randers-Pehrson, and are distributed according to the same disclaimer and license as libpng-1.0.6 with the following individuals added to the list of Contributing Authors

Simon-Pierre Cadieux  
Eric S. Raymond  
Gilles Vollant

and with the following additions to the disclaimer:

There is no warranty against interference with your enjoyment of the library or against infringement. There is no warranty that our efforts or the library will fulfill any of your particular purposes or needs. This library is provided with all faults, and the entire risk of satisfactory quality, performance, accuracy, and effort is with the user.

libpng versions 0.97, January 1998, through 1.0.6, March 20, 2000, are Copyright (c) 1998, 1999 Glenn Randers-Pehrson, and are distributed according to the same disclaimer and license as libpng-0.96, with the following individuals added to the list of Contributing Authors:

Tom Lane  
Glenn Randers-Pehrson  
Willem van Schaik

libpng versions 0.89, June 1996, through 0.96, May 1997, are Copyright (c) 1996, 1997 Andreas Dilger  
Distributed according to the same disclaimer and license as libpng-0.88, with the following individuals added to the list of Contributing Authors:

John Bowler  
Kevin Bracey  
Sam Bushell  
Magnus Holmgren  
Greg Roelofs  
Tom Tanner

libpng versions 0.5, May 1995, through 0.88, January 1996, are Copyright (c) 1995, 1996 Guy Eric Schalnat, Group 42, Inc.

For the purposes of this copyright and license, "Contributing Authors" is defined as the following set of individuals:

Andreas Dilger  
Dave Martindale  
Guy Eric Schalnat  
Paul Schmidt  
Tim Wegner

The PNG Reference Library is supplied "AS IS". The Contributing Authors and Group 42, Inc. disclaim all warranties, expressed or implied, including, without limitation, the warranties of merchantability and of fitness for any purpose. The Contributing Authors and Group 42, Inc. assume no liability for direct, indirect, incidental, special, exemplary or consequential damages, which may result from the use of the PNG Reference Library, even if advised of the possibility of such damage.

Permission is hereby granted to use, copy, modify, and distribute this source code, or portions hereof, for any purpose, without fee, subject to the following restrictions:

1. The origin of this source code must not be misrepresented.
2. Altered versions must be plainly marked as such and must not be misrepresented as being the original source.
3. This Copyright notice may not be removed or altered from any source or altered source distribution.

The Contributing Authors and Group 42, Inc. specifically permit, without fee, and encourage the use of this source code as a component to supporting the PNG file format in commercial products. If you use this source code in a product, acknowledgment is not required but would be appreciated.

A "png\_get\_copyright" function is available, for convenient use in "about" boxes and the like:

```
printf("%s",png_get_copyright(NULL));
```

Also, the PNG logo (in PNG format, of course) is supplied in the files "pngbar.png" and "pngbar.jpg (88x31)" and "pngnow.png" (98x31).

Libpng is OSI Certified Open Source Software. OSI Certified Open Source is a certification mark of the Open Source Initiative.

Glenn Randers-Pehrson  
glennrp at users.sourceforge.net  
August 21, 2014

-----

README for libpng version 1.5.19 - August 21, 2014 (shared library 15.0)  
See the note about version numbers near the top of png.h

See INSTALL for instructions on how to install libpng.

Libpng comes in several distribution formats. Get libpng-\*.tar.gz, libpng-\*.tar.xz or libpng-\*.tar.bz2 if you want UNIX-style line endings in the text files, or lpng\*.7z or lpng\*.zip if you want DOS-style line endings.

Version 0.89 was the first official release of libpng. Don't let the fact that it's the first release fool you. The libpng library has been in extensive use and testing since mid-1995. By late 1997 it had finally gotten to the stage where there hadn't been significant changes to the API in some time, and people have a bad feeling about libraries with versions < 1.0. Version 1.0.0 was released in March 1998.

\*\*\*\*

Note that some of the changes to the png\_info structure render this version of the library binary incompatible with libpng-0.89 or earlier versions if you are using a shared library. The type of the "filter" parameter for png\_set\_filter() has changed from png\_byte to png\_uint\_32, which will affect shared-library applications that use this function.

To avoid problems with changes to the internals of png\_info\_struct, new APIs have been made available in 0.95 to avoid direct application access to info\_ptr. These functions are the png\_set\_chunk\* and png\_get\_chunk\* functions. These functions should be used when accessing/storing the info\_struct data, rather than manipulating it directly, to avoid such problems in the future.

It is important to note that the APIs do not make current programs that access the info\_struct directly incompatible with the new library. However, it is strongly suggested that new programs use the new APIs (as shown in example.c and pngtest.c), and older programs be converted to the new format, to facilitate upgrades in the future.

\*\*\*\*

Additions since 0.90 include the ability to compile libpng as a Windows DLL, and new APIs for accessing data in the info\_struct. Experimental functions include the ability to set weighting and cost factors for row filter selection, direct reads of integers from buffers on big-endian processors that support misaligned data access, faster methods of doing alpha composition, and more accurate 16->8 bit color conversion.

The additions since 0.89 include the ability to read from a PNG stream which has had some (or all) of the signature bytes read by the calling application. This also allows the reading of embedded PNG streams that do not have the PNG file signature. As well, it is now possible to set the library action on the detection of chunk CRC errors. It is possible to set different actions based on whether the CRC error occurred in a critical or an ancillary chunk.

The changes made to the library, and bugs fixed are based on discussions on the PNG-implement mailing list and not on material submitted privately to Guy, Andreas, or Glenn. They will forward any good suggestions to the list.

For a detailed description on using libpng, read libpng-manual.txt. For examples of libpng in a program, see example.c and pngtest.c. For usage information and restrictions (what little they are) on libpng, see png.h. For a description on using zlib (the compression library used by libpng) and zlib's restrictions, see zlib.h.

I have included a general makefile, as well as several machine and compiler specific ones, but you may have to modify one for your own needs.

You should use zlib 1.0.4 or later to run this, but it MAY work with versions as old as zlib 0.95. Even so, there are bugs in older zlib versions which can cause the output of invalid compression streams for some images. You will definitely need zlib 1.0.4 or later if you are taking advantage of the MS-DOS "far" structure allocation for the small and medium memory models. You should also note that zlib is a compression library that is useful for more things than just PNG files. You can use zlib as a drop-in replacement for fread() and fwrite() if you are so inclined.

zlib should be available at the same place that libpng is, or at zlib.net.

You may want a copy of the PNG specification. It is available as an RFC, a W3C Recommendation, and an ISO/IEC Standard. You can find these at <http://www.libpng.org/pub/png/documents/>

This code is currently being archived at [libpng.sf.net](http://libpng.sf.net) in the [DOWNLOAD] area, and at [ftp://ftp.simplesystems.org](http://ftp.simplesystems.org). If you can't find it in any of those places, e-mail me, and I'll help you find it.

I am not a lawyer, but I believe that the Export Control Classification Number (ECCN) for libpng is EAR99, which means not subject to export controls or International Traffic in Arms Regulations (ITAR) because it is open source, publicly available software, that does not contain any encryption software. See the EAR, paragraphs 734.3(b)(3) and 734.7(b).

If you have any code changes, requests, problems, etc., please e-mail them to me. Also, I'd appreciate any make files or project files, and any modifications you needed to make to get libpng to compile, along with a #define variable to tell what compiler/system you are on. If you needed to add transformations to libpng, or wish libpng would provide the image in a different way, drop me a note (and code, if possible), so I can consider supporting the transformation. Finally, if you get any warning messages when compiling libpng (note: not zlib), and they are easy to fix, I'd appreciate the fix. Please mention "libpng" somewhere in the subject line. Thanks.

This release was created and will be supported by myself (of course based in a large way on Guy's and Andreas' earlier work), and the PNGdevelopment group.

Send comments/corrections/commendations to [png-mng-implement@lists.sourceforge.net](mailto:png-mng-implement@lists.sourceforge.net) (subscription required; visit <https://lists.sourceforge.net/lists/listinfo/png-mng-implement> to subscribe) or to [glennrp@users.sourceforge.net](mailto:glennrp@users.sourceforge.net)

You can't reach Guy, the original libpng author, at the addresses given in previous versions of this document. He and Andreas will read mail addressed to the png-implement list, however.

Please do not send general questions about PNG. Send them to [png-mng-misc@lists.sf.net](mailto:png-mng-misc@lists.sf.net) (subscription required; visit <https://lists.sourceforge.net/lists/listinfo/png-mng-misc> to subscribe). If you have a question about something in the PNG specification that is related to using libpng, send it to me. Send me any questions that start with "I was using libpng, and ...". If in doubt, send questions to me. I'll bounce them to others, if necessary.

Please do not send suggestions on how to change PNG. We have been discussing PNG for nineteen years now, and it is official and finished. If you have suggestions for libpng, however, I'll gladly listen. Even if your suggestion is not used immediately, it may be used later.

Files in this distribution:

ANNOUNCE => Announcement of this version, with recent changes
CHANGES => Description of changes between libpng versions
KNOWNBUG => List of known bugs and deficiencies
LICENSE => License to use and redistribute libpng
README => This file
TODO => Things not implemented in the current library
YZKINFO => Statement of YZK compliance
example.c => Example code for using libpng functions
libpng.3 => manual page for libpng (includes libpng-manual.txt)
libpng-manual.txt => Description of libpng and its functions
libpngpf.3 => manual page for libpng's private functions
png.5 => manual page for the PNG format
png.c => Basic interface functions common to library
png.h => Library function and interface declarations (public)
pngpriv.h => Library function and interface declarations (private)
pngconf.h => System specific library configuration (public)
pngstruct.h => png\_struct declaration (private)
pnginfo.h => png\_info struct declaration (private)
pngdebug.h => debugging macros (private)
pngerror.c => Error/warning message I/O functions
pngget.c => Functions for retrieving info from struct
pngmem.c => Memory handling functions
pngbar.png => PNG logo, 88x31
pngnow.png => PNG logo, 98x31
pngpread.c => Progressive reading functions
pngread.c => Read data/helper high-level functions
pngrio.c => Lowest-level data read I/O functions
pngtran.c => Read data transformation functions
pngutil.c => Read data utility functions
pngset.c => Functions for storing data into the info\_struct
pngtest.c => Library test program
pngtest.png => Library test sample image
pngtrans.c => Common data transformation functions
pngwio.c => Lowest-level write I/O functions
pngwrite.c => High-level write functions
pngwtran.c => Write data transformations
pngwutil.c => Write utility functions
arm => Contains optimized code for the ARM platform
contrib => Contributions
gregbook => source code for PNG reading and writing, from Greg Roelofs "PNG: The Definitive Guide", O'Reilly, 1999
libtests => Contains the pngvalid.c test program
pngminim => Minimal decoder, encoder, and progressive decoder programs demonstrating use of pngusr.dfa
pngminus => Simple pnm2png and png2pnm programs
pngsuite => Test images
visupng => Contains a MSVC workspace for VisualPng
projects => Directory containing scripts for building libpng: building a DLL
owatcom => Contains a WATCOM project for building libpng
visualc71 => Contains a Microsoft Visual C++ (MSVC) workspace for building libpng and zlib
vstudio => Contains a Microsoft Visual C++ (MSVC) workspace for building libpng and zlib
scripts => Directory containing scripts for building libpng: (see scripts/README.txt for the list of scripts)

Good luck, and happy coding.

-Glenn Randers-Pehrson (current maintainer, since 1998)
Internet: glennrp at users.sourceforge.net

-Andreas Eric Dilger (former maintainer, 1996-1997)
Internet: adilger at enel.ucalgary.ca
Web: http://www-mddsp.enel.ucalgary.ca/People/adilger/

-Guy Eric Schalnat (original author and former maintainer, 1995-1996)
(formerly of Group 42, Inc)
Internet: gschal at infinnet.com

This product may include derivative work of all or part of

zlib version 1.2.8

which is governed by the following license terms and conditions:

ZLIB DATA COMPRESSION LIBRARY

zlib 1.2.8 is a general purpose data compression library. All the code is
thread safe. The data used by the zlib library is described by RFCs
(Request for Comments) 1950 to 1952 in the files
http://tools.ietf.org/html/rfc1950 (zlib format), rfc1951 (deflate format) and rfc1952 (gzip format).

All functions of the compression library are documented in the file zlib.h
(volunteer to write man pages welcome, contact zlib@gzip.org). A usage example
of the library is given in the file test/example.c which also tests that
the library is working correctly. Another example is given in the file test/minizip.c.
The compression library itself is composed of all source files in the root directory.

To compile all files and run the test program, follow the instructions given at
the top of Makefile.in. In short, ./configure; make test, and if that goes
well, 'make install' should work for most flavors of Unix. For Windows, use
one of the special makefiles in win32/ or contrib/vstudio/. For VMS, use make\_vms.com.

Questions about zlib should be sent to <zlib@gzip.org>, or to Gilles Vollant
<info@winimage.com> for the Windows DLL version. The zlib home page is
http://zlib.net/. Before reporting a problem, please check this site to
verify that you have the latest version of zlib; otherwise get the latest
version and check whether the problem still exists or not.

PLEASE read the zlib FAQ http://zlib.net/zlib\_faq.html before asking for help.

Mark Nelson <markn@ieee.org> wrote an article about zlib for the Jan. 1997
issue of Dr. Dobbs' Journal; a copy of the article is available at
http://marknelson.us/1997/01/01/zlib-engine/.

The changes made in version 1.2.8 are documented in the file ChangeLog.

Unsupported third party contributions are provided in directory contrib/.

zlib is available in Java using the java.util.zip package, documented at
http://java.sun.com/developer/technicalArticles/Programming/compression/.

A Perl interface to zlib written by Paul Marquess <pmqs@cpan.org> is available
at CPAN (Comprehensive Perl Archive Network) sites, including
http://search.cpan.org/~pmqs/IO-Compress-Zlib/.

A Python interface to zlib written by A.M. Kuchling <amk@amk.ca> is
available in Python 1.5 and later versions, see
http://docs.python.org/library/zlib.html.

zlib is built into tcl: http://wiki.tcl.tk/4610.

An experimental package to read and write files in .zip format, written on top
of zlib by Gilles Vollant <info@winimage.com>, is available in the
contrib/minizip directory of zlib.

Notes for some targets:

- For Windows DLL versions, please see win32/DLL\_FAQ.txt
- For 64-bit Irix, deflate.c must be compiled without any optimization, With
-O, one libpng test fails. The test works in 32 bit mode (with the -n32
compiler flag). The compiler bug has been reported to SGI.
- zlib doesn't work with gcc 2.6.3 on a DEC 3000/300LX under OSF/1 2.1 it works
when compiled with cc.
- On Digital Unix 4.0D (formerly OSF/1) on AlphaServer, the cc option -std1 is
necessary to get gzprintf working correctly. This is done by configure.
- zlib doesn't work on HP-UX 9.05 with some versions of /bin/cc. It works with
other compilers. Use "make test" to check your compiler.
- gzdopen is not supported on RISCOS or BEOS.
- For PalmOs, see http://palmzlib.sourceforge.net/

Acknowledgments:

The deflate format used by zlib was defined by Phil Katz. The deflate and
zlib specifications were written by L. Peter Deutsch. Thanks to all the
people who reported problems and suggested various improvements in zlib; they
are too numerous to cite here.

Copyright notice:

(C) 1995-2013 Jean-loup Gailly and Mark Adler

This software is provided 'as-is', without any express or implied
warranty. In no event will the authors be held liable for any damages
arising from the use of this software.

Permission is granted to anyone to use this software for any purpose,
including commercial applications, and to alter it and redistribute it
freely, subject to the following restrictions:

1. The origin of this software must not be misrepresented; you must not
claim that you wrote the original software. If you use this software
in a product, an acknowledgment in the product documentation would be
appreciated but is not required.
2. Altered source versions must be plainly marked as such, and must not be
misrepresented as being the original software.
3. This notice may not be removed or altered from any source distribution.

Jean-loup Gailly Mark Adler
jloup@gzip.org madler@alumni.caltech.edu

If you use the zlib library in a product, we would appreciate \*not\* receiving
lengthy legal documents to sign. The sources are provided for free but without
warranty of any kind. The library has been entirely written by Jean-loup
Gailly and Mark Adler; it does not include third-party code.

If you redistribute modified sources, we would appreciate that you include in
the file ChangeLog history information documenting your changes. Please read
the FAQ for more information on the distribution of modified source versions.

This product may include derivative work of all or part of

libxml2 version 2.9.1

which is governed by the following license terms and conditions:

Except where otherwise noted in the source code (e.g. the files hash.c,
list.c and the trio files, which are covered by a similar licence but
with different Copyright notices) all the files are:

Copyright (C) 1998-2012 Daniel Veillard. All Rights Reserved.

Permission is hereby granted, free of charge, to any person obtaining a copy
of this software and associated documentation files (the "Software"), to deal
in the Software without restriction, including without limitation the rights
to use, copy, modify, merge, publish, distribute, sublicense, and/or sell
copies of the Software, and to permit persons to whom the Software is fur-
nished to do so, subject to the following conditions:

The above copyright notice and this permission notice shall be included in
all copies or substantial portions of the Software.

THE SOFTWARE IS PROVIDED "AS IS", WITHOUT WARRANTY OF ANY KIND, EXPRESS OR
IMPLIED, INCLUDING BUT NOT LIMITED TO THE WARRANTIES OF MERCHANTABILITY, FIT-
NESS FOR A PARTICULAR PURPOSE AND NONINFRINGEMENT. IN NO EVENT SHALL THE
AUTHORS OR COPYRIGHT HOLDERS BE LIABLE FOR ANY CLAIM, DAMAGES OR OTHER
LIABILITY, WHETHER IN AN ACTION OF CONTRACT, TORT OR OTHERWISE, ARISING FROM,
OUT OF OR IN CONNECTION WITH THE SOFTWARE OR THE USE OR OTHER DEALINGS IN
THE SOFTWARE.

XML toolkit from the GNOME project

Full documentation is available on-line at
http://xmlsoft.org/

This code is released under the MIT Licence see the Copyright file.

To build on an Unixised setup:
./configure ; make ; make install
To build on Windows:
see instructions on win32/Readme.txt

To assert build quality:
on an Unixised setup:
run make tests
otherwise:
There is 3 standalone tools: runtest.c, runsuite.c, testapi.c, which
should compile as part of the build or as any application would.
Launch them from this directory to get results, runtest checks
the proper functioning of libxml2 main APIs while testapi does
a full coverage check. Report failures to the list.

To report bugs, follow the instructions at:
http://xmlsoft.org/bugs.html

A mailing-list xml@gnome.org is available, to subscribe:
http://mail.gnome.org/mailman/listinfo/xml

The list archive is at:
http://mail.gnome.org/archives/xml/

All technical answers asked privately will be automatically answered on
the list and archived for public access unless privacy is explicitly
required and justified.

Daniel Veillard

\$Id\$

# 本機で使われるソフトウェアライセンス情報 (つづき)

=====  
 =====

This product may include derivative work of all or part of  
 libcurl version 7.42.1  
 which is governed by the following license terms and conditions:

-----  
 COPYRIGHT AND PERMISSION NOTICE

Copyright (c) 1996 - 2015, Daniel Stenberg, <daniel@haxx.se>.

All rights reserved.

Permission to use, copy, modify, and distribute this software for any purpose with or without fee is hereby granted, provided that the above copyright notice and this permission notice appear in all copies.

THE SOFTWARE IS PROVIDED "AS IS", WITHOUT WARRANTY OF ANY KIND, EXPRESS OR IMPLIED, INCLUDING BUT NOT LIMITED TO THE WARRANTIES OF MERCHANTABILITY, FITNESS FOR A PARTICULAR PURPOSE AND NONINFRINGEMENT OF THIRD PARTY RIGHTS. IN NO EVENT SHALL THE AUTHORS OR COPYRIGHT HOLDERS BE LIABLE FOR ANY CLAIM, DAMAGES OR OTHER LIABILITY, WHETHER IN AN ACTION OF CONTRACT, TORT OR OTHERWISE, ARISING FROM, OUT OF OR IN CONNECTION WITH THE SOFTWARE OR THE USE OR OTHER DEALINGS IN THE SOFTWARE.

Except as contained in this notice, the name of a copyright holder shall not be used in advertising or otherwise to promote the sale, use or other dealings in this Software without prior written authorization of the copyright holder.



-----  
 README

Curl is a command line tool for transferring data specified with URL syntax. Find out how to use curl by reading the curl.1 man page or the MANUAL document. Find out how to install Curl by reading the INSTALL document.

libcurl is the library curl is using to do its job. It is readily available to be used by your software. Read the libcurl.3 man page to learn how!

You find answers to the most frequent questions we get in the FAQ document.

Study the COPYING file for distribution terms and similar. If you distribute curl binaries or other binaries that involve libcurl, you might enjoy the LICENSE-MIXING document.

CONTACT

If you have problems, questions, ideas or suggestions, please contact us by posting to a suitable mailing list. See <http://curl.haxx.se/mail/>

All contributors to the project are listed in the THANKS document.

WEB SITE

Visit the curl web site for the latest news and downloads:

<http://curl.haxx.se/>

GIT

To download the very latest source off the GIT server do this:

```
git clone git://github.com/bagder/curl.git
```

(you'll get a directory named curl created, filled with the source code)

NOTICE

Curl contains pieces of source code that is Copyright (c) 1998, 1999 Kungliga Tekniska Högskolan. This notice is included here to comply with the distribution terms.

=====  
 =====

This product may include derivative work of all or part of  
 OpenSSL version 1.0.1i  
 which is governed by the following license terms and conditions:

-----  
 LICENSE ISSUES

The OpenSSL toolkit stays under a dual license, i.e. both the conditions of the OpenSSL License and the original SSLeay license apply to the toolkit. See below for the actual license texts. Actually both licenses are BSD-style Open Source licenses. In case of any license issues related to OpenSSL please contact [openssl-core@openssl.org](mailto:openssl-core@openssl.org).

-----  
 OpenSSL License

```
/*
 * Copyright (c) 1998-2011 The OpenSSL Project. All rights reserved.
 *
 * Redistribution and use in source and binary forms, with or without
 * modification, are permitted provided that the following conditions
 * are met:
 *
 * 1. Redistributions of source code must retain the above copyright
 * notice, this list of conditions and the following disclaimer.
 *
 * 2. Redistributions in binary form must reproduce the above copyright
 * notice, this list of conditions and the following disclaimer in the
 * documentation and/or other materials provided with the
 * distribution.
 *
 * 3. All advertising materials mentioning features or use of this
 * software must display the following acknowledgement:
 * "This product includes software developed by the OpenSSL Project
 * for use in the OpenSSL Toolkit. (http://www.openssl.org/)"
 *
 * 4. The names "OpenSSL Toolkit" and "OpenSSL Project" must not be used to
 * endorse or promote products derived from this software without
 * prior written permission. For written permission, please contact
 * openssl-core@openssl.org.
 *
 * 5. Products derived from this software may not be called "OpenSSL"
 * nor may "OpenSSL" appear in their names without prior written
```

```
* permission of the OpenSSL Project.
*
* 6. Redistributions of any form whatsoever must retain the following
 * acknowledgement:
 * This product includes software developed by the OpenSSL Project
 * for use in the OpenSSL Toolkit (http://www.openssl.org/)
 *
 * THIS SOFTWARE IS PROVIDED BY THE OpenSSL PROJECT "AS IS" AND ANY
 * EXPRESSED OR IMPLIED WARRANTIES, INCLUDING, BUT NOT LIMITED TO, THE
 * IMPLIED WARRANTIES OF MERCHANTABILITY AND FITNESS FOR A PARTICULAR
 * PURPOSE ARE DISCLAIMED. IN NO EVENT SHALL THE OpenSSL PROJECT OR
 * ITS CONTRIBUTORS BE LIABLE FOR ANY DIRECT, INDIRECT, INCIDENTAL,
 * SPECIAL, EXEMPLARY, OR CONSEQUENTIAL DAMAGES (INCLUDING, BUT
 * NOT LIMITED TO, PROCUREMENT OF SUBSTITUTE GOODS OR SERVICES;
 * LOSS OF USE, DATA, OR PROFITS; OR BUSINESS INTERRUPTION)
 * HOWEVER CAUSED AND ON ANY THEORY OF LIABILITY, WHETHER IN CONTRACT,
 * STRICT LIABILITY, OR TORT (INCLUDING NEGLIGENCE OR OTHERWISE)
 * ARISING IN ANY WAY OUT OF THE USE OF THIS SOFTWARE, EVEN IF ADVISED
 * OF THE POSSIBILITY OF SUCH DAMAGE.
 *
 * =====
```

```
* This product includes cryptographic software written by Eric Young
 * (eay@cryptsoft.com). This product includes software written by Tim
 * Hudson (tjh@cryptsoft.com).
```

-----  
 Original SSLeay License

```
/* Copyright (C) 1995-1998 Eric Young (eay@cryptsoft.com)
 * All rights reserved.
 *
 * This package is an SSL implementation written
 * by Eric Young (eay@cryptsoft.com).
 * The implementation was written so as to conform with Netscapes SSL.
 *
 * This library is free for commercial and non-commercial use as long as
 * the following conditions are aheared to. The following conditions
 * apply to all code found in this distribution, be it the RC4, RSA,
 * the sha1, des, etc. codes; not just the SSL code. The SSL
 * documentation included with this distribution is covered by the same copyright terms
 * except that the holder is Tim Hudson (tjh@cryptsoft.com).
 *
 * Copyright remains Eric Young's, and as such any Copyright notices in
 * the code are not to be removed.
 * If this package is used in a product, Eric Young should be given attribution
 * as the author of the parts of the library used.
 * This can be in the form of a textual message at program startup or
 * in documentation (online or textual) provided with the package.
 *
 * Redistribution and use in source and binary forms, with or without
 * modification, are permitted provided that the following conditions
 * are met:
 * 1. Redistributions of source code must retain the copyright
 * notice, this list of conditions and the following disclaimer.
 * 2. Redistributions in binary form must reproduce the above copyright
 * notice, this list of conditions and the following disclaimer in the
 * documentation and/or other materials provided with the distribution.
 * 3. All advertising materials mentioning features or use of this software
 * must display the following acknowledgement:
 * "This product includes cryptographic software written by
 * Eric Young (eay@cryptsoft.com)"
 * The word "cryptographic" can be left out if the rouines from the library
 * being used are not cryptographic related :-).
 * 4. If you include any Windows specific code (or a derivative thereof) from
 * the apps directory (application code) you must include an acknowledgement:
 * "This product includes software written by Tim Hudson (tjh@cryptsoft.com)"
 *
 * THIS SOFTWARE IS PROVIDED BY ERIC YOUNG "AS IS" AND
 * ANY EXPRESS OR IMPLIED WARRANTIES, INCLUDING, BUT NOT LIMITED TO, THE
 * IMPLIED WARRANTIES OF MERCHANTABILITY AND FITNESS FOR A PARTICULAR PURPOSE
 * ARE DISCLAIMED. IN NO EVENT SHALL THE AUTHOR OR CONTRIBUTORS BE LIABLE
 * FOR ANY DIRECT, INDIRECT, INCIDENTAL, SPECIAL, EXEMPLARY, OR CONSEQUENTIAL
 * DAMAGES (INCLUDING, BUT NOT LIMITED TO, PROCUREMENT OF SUBSTITUTE GOODS
 * OR SERVICES; LOSS OF USE, DATA, OR PROFITS; OR BUSINESS INTERRUPTION)
 * HOWEVER CAUSED AND ON ANY THEORY OF LIABILITY, WHETHER IN CONTRACT, STRICT
 * LIABILITY, OR TORT (INCLUDING NEGLIGENCE OR OTHERWISE) ARISING IN ANY WAY
 * OUT OF THE USE OF THIS SOFTWARE, EVEN IF ADVISED OF THE POSSIBILITY OF
 * SUCH DAMAGE.
 *
 * The licence and distribution terms for any publically available version or
 * derivative of this code cannot be changed. i.e. this code cannot simply be
 * copied and put under another distribution licence
 * [including the GNU Public Licence.]
 */
```

-----  
 OpenSSL 1.0.1i 6 Aug 2014

Copyright (c) 1998-2011 The OpenSSL Project  
 Copyright (c) 1995-1998 Eric A. Young, Tim J. Hudson  
 All rights reserved.

-----  
 DESCRIPTION

The OpenSSL Project is a collaborative effort to develop a robust, commercial-grade, fully featured, and Open Source toolkit implementing the Secure Sockets Layer (SSL v2/v3) and Transport Layer Security (TLS v1) protocols as well as a full-strength general purpose cryptography library. The project is managed by a worldwide community of volunteers that use the Internet to communicate, plan, and develop the OpenSSL toolkit and its related documentation.

OpenSSL is based on the excellent SSLeay library developed from Eric A. Young and Tim J. Hudson. The OpenSSL toolkit is licensed under a dual-license (the OpenSSL license plus the SSLeay license) situation, which basically means that you are free to get and use it for commercial and non-commercial purposes as long as you fulfill the conditions of both licenses.

-----  
 OVERVIEW

The OpenSSL toolkit includes:

**libssl.a:**  
 Implementation of SSLv2, SSLv3, TLSv1 and the required code to support both SSLv2, SSLv3 and TLSv1 in the one server and client.

**libcrypto.a:**  
 General encryption and X.509 v1/v3 stuff needed by SSL/TLS but not actually logically part of it. It includes routines for the following:

**Ciphers**  
**libdes -** EAY's libdes DES encryption package which was floating around the net for a few years, and was then relicensed by him as part of SSLeay. It includes 15 "modes/variations" of DES (1, 2 and 3 key versions of ecb, cbc, cfb and ofb; pcbc and a more general form of cfb and ofb) including `desx` in cbc mode, a fast crypt(3), and routines to read passwords from the keyboard.  
**RC4 encryption,**  
**RC2 encryption -** 4 different modes, ecb, cbc, cfb and ofb.



Blowfish encryption - 4 different modes, ecb, cbc, cfb and ofb.  
IDEA encryption - 4 different modes, ecb, cbc, cfb and ofb.

Digests  
MD5 and MD2 message digest algorithms, fast implementations,  
SHA (SHA-0) and SHA-1 message digest algorithms,  
MDCC message digest. A DES based hash that is popular on smart cards.

Public Key  
RSA encryption/decryption/generation.  
There is no limit on the number of bits.  
DSA encryption/decryption/generation.  
There is no limit on the number of bits.  
Diffie-Hellman key-exchange/key generation.  
There is no limit on the number of bits.

X.509v3 certificates  
X509 encoding/decoding into/from binary ASN1 and a PEM  
based ASCII-binary encoding which supports encryption with a  
private key. Program to generate RSA and DSA certificate  
requests and to generate RSA and DSA certificates.

Systems  
The normal digital envelope routines and base64 encoding. Higher  
level access to ciphers and digests by name. New ciphers can be  
loaded at run time. The BIO io system which is a simple non-blocking  
IO abstraction. Current methods supported are file descriptors,  
sockets, socket accept, socket connect, memory buffer, buffering, SSL  
client/server, file pointer, encryption, digest, non-blocking testing  
and null.

Data structures  
A dynamically growing hashing system  
A simple stack.  
A configuration loader that uses a format similar to MS .ini files.

openssl:  
A command line tool that can be used for:  
Creation of RSA, DH and DSA key parameters  
Creation of X.509 certificates, CSRs and CRLs  
Calculation of Message Digests  
Encryption and Decryption with Ciphers  
SSL/TLS Client and Server Tests  
Handling of S/MIME signed or encrypted mail

## PATENTS

Various companies hold various patents for various algorithms in various  
locations around the world. YOU are responsible for ensuring that your use  
of any algorithms is legal by checking if there are any patents in your  
country. The file contains some of the patents that we know about or are  
rumored to exist. This is not a definitive list.

RSA Security holds software patents on the RC5 algorithm. If you  
intend to use this cipher, you must contact RSA Security for  
licensing conditions. Their web page is <http://www.rsasecurity.com/>.

RC4 is a trademark of RSA Security, so use of this label should perhaps  
only be used with RSA Security's permission.

The IDEA algorithm is patented by Ascom in Austria, France, Germany, Italy,  
Japan, the Netherlands, Spain, Sweden, Switzerland, UK and the USA. They  
should be contacted if that algorithm is to be used; their web page is <http://www.ascom.ch/>.

NTT and Mitsubishi have patents and pending patents on the Camellia  
algorithm, but allow use at no charge without requiring an explicit  
licensing agreement: <http://info.isl.ntt.co.jp/crypt/eng/info/chiteki.html>

## INSTALLATION

To install this package under a Unix derivative, read the INSTALL file. For  
a Win32 platform, read the INSTALL.W32 file. For OpenVMS systems, read INSTALL.VMS.

Read the documentation in the doc/ directory. It is quite rough, but it  
lists the functions; you will probably have to look at the code to work out  
how to use them. Look at the example programs.

## PROBLEMS

For some platforms, there are some known problems that may affect the user  
or application author. We try to collect those in doc/PROBLEMS, with current  
thoughts on how they should be solved in a future of OpenSSL.

## SUPPORT

See the OpenSSL website [www.openssl.org](http://www.openssl.org) for details of how to obtain  
commercial technical support.

If you have any problems with OpenSSL then please take the following steps  
first:

- Download the current snapshot from <ftp://ftp.openssl.org/snapshot/>  
to see if the problem has already been addressed
- Remove ASM versions of libraries
- Remove compiler optimisation flags

If you wish to report a bug then please include the following information in  
any bug report:

- On Unix systems:  
Self-test report generated by 'make report'
- On other systems:  
OpenSSL version: output of 'openssl version -a'  
OS Name, Version, Hardware platform  
Compiler Details (name, version)
- Application Details (name, version)
- Problem Description (steps that will reproduce the problem, if known)
- Stack Traceback (if the application dumps core)

Report the bug to the OpenSSL project via the Request Tracker  
(<http://www.openssl.org/support/rt.html>) by mail to:

[openssl-bugs@openssl.org](mailto:openssl-bugs@openssl.org)

Note that the request tracker should NOT be used for general assistance  
or support queries. Just because something doesn't work the way you expect  
does not mean it is necessarily a bug in OpenSSL.

Note that mail to [openssl-bugs@openssl.org](mailto:openssl-bugs@openssl.org) is recorded in the publicly  
readable request tracker database and is forwarded to a public  
mailing list. Confidential mail may be sent to [openssl-security@openssl.org](mailto:openssl-security@openssl.org)  
(PGP key available from the key servers).

## HOW TO CONTRIBUTE TO OpenSSL

Development is coordinated on the openssl-dev mailing list (see  
<http://www.openssl.org> for information on subscribing). If you  
would like to submit a patch, send it to [openssl-bugs@openssl.org](mailto:openssl-bugs@openssl.org) with  
the string "[PATCH]" in the subject. Please be sure to include a  
textual explanation of what your patch does.

If you are unsure as to whether a feature will be useful for the general  
OpenSSL community please discuss it on the openssl-dev mailing list first.  
Someone may be already working on the same thing or there may be a good  
reason as to why that feature isn't implemented.

Patches should be as up to date as possible, preferably relative to the  
current Git or the last snapshot. They should follow the coding style of  
OpenSSL and compile without warnings. Some of the core team developer targets  
can be used for testing purposes, (debug-steve64, debug-geoff etc). OpenSSL  
compiles on many varied platforms: try to ensure you only use portable  
features.

Note: For legal reasons, contributions from the US can be accepted only  
if a TSU notification and a copy of the patch are sent to [crypt@bis.doc.gov](mailto:crypt@bis.doc.gov)  
(formerly BXA) with a copy to the ENC Encryption Request Coordinator;  
please take some time to look at  
<http://www.bis.doc.gov/Encryption/PubAvailEncSourceCodeNofly.html> [sic]  
and  
<http://w3.access.gpo.gov/bis/ear/pdf/740.pdf> (EAR Section 740.13(e))  
for the details. If "your encryption source code is too large to serve as  
an email attachment", they are glad to receive it by fax instead; hope you  
have a cheap long-distance plan.

Our preferred format for changes is "diff -u" output. You might  
generate it like this:

```
# cd openssl-work
# (your changes)
# ./Configure dist; make clean
# cd .
# diff -ur openssl-orig openssl-work > mydiffs.patch
```

-----  
This product may include derivative work of all or part of

libxslt version 1.1.28

which is governed by the following license terms and conditions:

-----  
Licence for libxslt except libxslt

Copyright (C) 2001-2002 Daniel Veillard. All Rights Reserved.

Permission is hereby granted, free of charge, to any person obtaining a copy  
of this software and associated documentation files (the "Software"), to deal  
in the Software without restriction, including without limitation the rights to  
use, copy, modify, merge, publish, distribute, sublicense, and/or sell  
copies of the Software, and to permit persons to whom the Software is fur-  
nished to do so, subject to the following conditions:

The above copyright notice and this permission notice shall be included in  
all copies or substantial portions of the Software.

THE SOFTWARE IS PROVIDED "AS IS", WITHOUT WARRANTY OF ANY KIND, EXPRESS OR  
IMPLIED, INCLUDING BUT NOT LIMITED TO THE WARRANTIES OF MERCHANTABILITY, FIT-  
NESS FOR A PARTICULAR PURPOSE AND NONINFRINGEMENT. IN NO EVENT SHALL THE  
DANIEL VEILLARD BE LIABLE FOR ANY CLAIM, DAMAGES OR OTHER LIABILITY, WHETHER  
IN AN ACTION OF CONTRACT, TORT OR OTHERWISE, ARISING FROM, OUT OF OR IN CON-  
NECTION WITH THE SOFTWARE OR THE USE OR OTHER DEALINGS IN THE SOFTWARE.

Except as contained in this notice, the name of Daniel Veillard shall not  
be used in advertising or otherwise to promote the sale, use or other deal-  
ings in this Software without prior written authorization from him.

-----  
Licence for libxslt

Copyright (C) 2001-2002 Thomas Broyer, Charlie Bozeman and Daniel Veillard.  
All Rights Reserved.

Permission is hereby granted, free of charge, to any person obtaining a copy  
of this software and associated documentation files (the "Software"), to deal  
in the Software without restriction, including without limitation the rights to  
use, copy, modify, merge, publish, distribute, sublicense, and/or sell  
copies of the Software, and to permit persons to whom the Software is fur-  
nished to do so, subject to the following conditions:

The above copyright notice and this permission notice shall be included in  
all copies or substantial portions of the Software.

THE SOFTWARE IS PROVIDED "AS IS", WITHOUT WARRANTY OF ANY KIND, EXPRESS OR  
IMPLIED, INCLUDING BUT NOT LIMITED TO THE WARRANTIES OF MERCHANTABILITY, FIT-  
NESS FOR A PARTICULAR PURPOSE AND NONINFRINGEMENT. IN NO EVENT SHALL THE  
AUTHORS BE LIABLE FOR ANY CLAIM, DAMAGES OR OTHER LIABILITY, WHETHER  
IN AN ACTION OF CONTRACT, TORT OR OTHERWISE, ARISING FROM, OUT OF OR IN CON-  
NECTION WITH THE SOFTWARE OR THE USE OR OTHER DEALINGS IN THE SOFTWARE.

Except as contained in this notice, the name of the authors shall not  
be used in advertising or otherwise to promote the sale, use or other deal-  
ings in this Software without prior written authorization from him.

-----  
XSLT support for libxml2 (XML toolkit from the GNOME project)

Full documentation is available on-line at  
<http://xmlsoft.org/XSLT/>

This code is released under the MIT Licence see the Copyright file.

To report bugs, follow the instructions at:  
<http://xmlsoft.org/XSLT/bugs.html>

A mailing-list [xslt@gnome.org](mailto:xslt@gnome.org) is available, to subscribe:  
<http://mail.gnome.org/mailman/listinfo/xslt>

The list archive is at:  
<http://mail.gnome.org/archives/xslt/>

All technical answers asked privately will be automatically answered on  
the list and archived for public access unless privacy is explicitly  
required and justified.

Daniel Veillard

\$Id\$

-----  
This product may include derivative work of all or part of

ICU Unicode libraries version 4.8.1

which is governed by the following license terms and conditions:

-----  
ICU License - ICU 1.8.1 and later

COPYRIGHT AND PERMISSION NOTICE

# 本機で使われるソフトウェアライセンス情報 (つづき)

Copyright (c) 1995-2011 International Business Machines Corporation and others

All rights reserved.

Permission is hereby granted, free of charge, to any person obtaining a copy of this software and associated documentation files (the "Software"), to deal in the Software without restriction, including without limitation the rights to use, copy, modify, merge, publish, distribute, and/or sell copies of the Software, and to permit persons to whom the Software is furnished to do so, provided that the above copyright notice(s) and this permission notice appear in all copies of the Software and that both the above copyright notice(s) and this permission notice appear in supporting documentation.

THE SOFTWARE IS PROVIDED "AS IS", WITHOUT WARRANTY OF ANY KIND, EXPRESS OR IMPLIED, INCLUDING BUT NOT LIMITED TO THE WARRANTIES OF MERCHANTABILITY, FITNESS FOR A PARTICULAR PURPOSE AND NONINFRINGEMENT OF THIRD PARTY RIGHTS. IN NO EVENT SHALL THE COPYRIGHT HOLDER OR HOLDERS INCLUDED IN THIS NOTICE BE LIABLE FOR ANY CLAIM, OR ANY SPECIAL INDIRECT OR CONSEQUENTIAL DAMAGES, OR ANY DAMAGES WHATSOEVER RESULTING FROM LOSS OF USE, DATA OR PROFITS, WHETHER IN AN ACTION OF CONTRACT, NEGLIGENCE OR OTHER TORTIOUS ACTION, ARISING OUT OF OR IN CONNECTION WITH THE USE OR PERFORMANCE OF THIS SOFTWARE.

Except as contained in this notice, the name of a copyright holder shall not be used in advertising or otherwise to promote the sale, use or other dealings in this Software without prior written authorization of the copyright holder.

## UNICODE, INC. LICENSE AGREEMENT - DATA FILES AND SOFTWARE

Unicode Data Files include all data files under the directories <http://www.unicode.org/Public/>, <http://www.unicode.org/reports/>, and <http://www.unicode.org/cldr/data/>. Unicode Data Files do not include PDF online code charts under the directory <http://www.unicode.org/Public/>. Software includes any source code published in the Unicode Standard or under the directories <http://www.unicode.org/Public/>, <http://www.unicode.org/reports/>, and <http://www.unicode.org/cldr/data/>.

NOTICE TO USER: Carefully read the following legal agreement. BY DOWNLOADING, INSTALLING, COPYING OR OTHERWISE USING UNICODE INC.'S DATA FILES ("DATA FILES") AND/OR SOFTWARE ("SOFTWARE"), YOU UNEQUIVOCALLY ACCEPT AND AGREE TO BE BOUND BY ALL OF THE TERMS AND CONDITIONS OF THIS AGREEMENT. IF YOU DO NOT AGREE, DO NOT DOWNLOAD, INSTALL, COPY, DISTRIBUTE OR USE THE DATA FILES OR SOFTWARE.

### COPYRIGHT AND PERMISSION NOTICE

Copyright © 1991-2011 Unicode, Inc. All rights reserved. Distributed under the Terms of Use in <http://www.unicode.org/copyright.html>.

Permission is hereby granted, free of charge, to any person obtaining a copy of the Unicode data files and any associated documentation (the "Data Files") or Unicode software and any associated documentation (the "Software") to deal in the Data Files or Software without restriction, including without limitation the rights to use, copy, modify, merge, publish, distribute, and/or sell copies of the Data Files or Software, and to permit persons to whom the Data Files or Software are furnished to do so, provided that (a) the above copyright notice(s) and this permission notice appear with all copies of the Data Files or Software, (b) both the above copyright notice(s) and this permission notice appear in associated documentation, and (c) there is clear notice in each modified Data File or in the Software as well as in the documentation associated with the Data File(s) or Software that the data or software has been modified.

THE DATA FILES AND SOFTWARE ARE PROVIDED "AS IS", WITHOUT WARRANTY OF ANY KIND, EXPRESS OR IMPLIED, INCLUDING BUT NOT LIMITED TO THE WARRANTIES OF MERCHANTABILITY, FITNESS FOR A PARTICULAR PURPOSE AND NONINFRINGEMENT OF THIRD PARTY RIGHTS. IN NO EVENT SHALL THE COPYRIGHT HOLDER OR HOLDERS INCLUDED IN THIS NOTICE BE LIABLE FOR ANY CLAIM, OR ANY SPECIAL INDIRECT OR CONSEQUENTIAL DAMAGES, OR ANY DAMAGES WHATSOEVER RESULTING FROM LOSS OF USE, DATA OR PROFITS, WHETHER IN AN ACTION OF CONTRACT, NEGLIGENCE OR OTHER TORTIOUS ACTION, ARISING OUT OF OR IN CONNECTION WITH THE USE OR PERFORMANCE OF THE DATA FILES OR SOFTWARE.

Except as contained in this notice, the name of a copyright holder shall not be used in advertising or otherwise to promote the sale, use or other dealings in these Data Files or Software without prior written authorization of the copyright holder.

This product includes modified work of Unicode Character Databases listed below.

- BidIMirroring.txt
- CaseFolding.txt
- Linebreak.txt
- UnicodeData.txt

=====  
This product may include derivative work of all or part of

Unicode 6.0.0

which is governed by the following license terms and conditions:

## UNICODE, INC. LICENSE AGREEMENT - DATA FILES AND SOFTWARE

Unicode Data Files include all data files under the directories <http://www.unicode.org/Public/>, <http://www.unicode.org/reports/>, and <http://www.unicode.org/cldr/data/>. Unicode Data Files do not include PDF online code charts under the directory <http://www.unicode.org/Public/>. Software includes any source code published in the Unicode Standard or under the directories <http://www.unicode.org/Public/>, <http://www.unicode.org/reports/>, and <http://www.unicode.org/cldr/data/>.

NOTICE TO USER: Carefully read the following legal agreement. BY DOWNLOADING, INSTALLING, COPYING OR OTHERWISE USING UNICODE INC.'S DATA FILES ("DATA FILES") AND/OR SOFTWARE ("SOFTWARE"), YOU UNEQUIVOCALLY ACCEPT AND AGREE TO BE BOUND BY ALL OF THE TERMS AND CONDITIONS OF THIS AGREEMENT. IF YOU DO NOT AGREE, DO NOT DOWNLOAD, INSTALL, COPY, DISTRIBUTE OR USE THE DATA FILES OR SOFTWARE.

### COPYRIGHT AND PERMISSION NOTICE

Copyright © 1991-2011 Unicode, Inc. All rights reserved. Distributed under the Terms of Use in <http://www.unicode.org/copyright.html>.

Permission is hereby granted, free of charge, to any person obtaining a copy of the Unicode data files and any associated documentation (the "Data Files") or Unicode software and any associated documentation (the "Software") to deal in the Data Files or Software without restriction, including without limitation the rights to use, copy, modify, merge, publish, distribute, and/or sell copies of the Data Files or Software, and to permit persons to whom the Data Files or Software are furnished to do so, provided that (a) the above copyright notice(s) and this permission notice appear with all copies of the Data Files or Software, (b) both the above copyright notice(s) and this permission notice appear in associated documentation, and (c) there is clear notice in each modified Data File or in the Software as well as in the documentation associated with the Data File(s) or Software that the data or software has been modified.

THE DATA FILES AND SOFTWARE ARE PROVIDED "AS IS", WITHOUT WARRANTY OF ANY KIND, EXPRESS OR IMPLIED, INCLUDING BUT NOT LIMITED TO THE WARRANTIES OF MERCHANTABILITY, FITNESS FOR A PARTICULAR PURPOSE AND NONINFRINGEMENT OF THIRD PARTY RIGHTS. IN NO EVENT SHALL THE COPYRIGHT HOLDER OR HOLDERS INCLUDED IN THIS NOTICE BE LIABLE FOR ANY CLAIM, OR ANY SPECIAL INDIRECT OR CONSEQUENTIAL DAMAGES, OR ANY DAMAGES WHATSOEVER RESULTING FROM LOSS OF USE, DATA OR PROFITS, WHETHER IN AN ACTION OF CONTRACT, NEGLIGENCE OR OTHER TORTIOUS ACTION, ARISING OUT OF OR IN CONNECTION WITH THE USE OR PERFORMANCE OF THE

DATA FILES OR SOFTWARE.

Except as contained in this notice, the name of a copyright holder shall not be used in advertising or otherwise to promote the sale, use or other dealings in these Data Files or Software without prior written authorization of the copyright holder.

=====  
This product may include derivative work of all or part of

SQLite version 3.8.6

which is governed by the following license terms and conditions:

=====  
\*\* This file is an amalgamation of many separate C source files from SQLite version 3.8.6. By combining all the individual C code files into this single large file, the entire code can be compiled as a single translation unit. This allows many compilers to do optimizations that would not be possible if the files were compiled separately. Performance improvements of 5% or more are commonly seen when SQLite is compiled as a single translation unit.  
\*\* This file is all you need to compile SQLite. To use SQLite in other programs, you need this file and the "sqlite3.h" header file that defines the programming interface to the SQLite library. (If you do not have the "sqlite3.h" header file at hand, you will find a copy embedded within the text of this file. Search for "Begin file sqlite3.h" to find the start of the embedded sqlite3.h header file.) Additional code files may be needed \*\* if you want a wrapper to interface SQLite with your choice of programming language. The code for the "sqlite3" command-line shell is also in a separate file. This file contains only code for the core SQLite library.  
=====

=====  
This product may include derivative work of all or part of

Public Suffix List

which is governed by the following license terms and conditions:

=====  
This Source Code Form is subject to the terms of the Mozilla Public License, v. 2.0. If a copy of the MPL was not distributed with this file, You can obtain one at <http://mozilla.org/MPL/2.0/>.  
=====

=====  
This product may include derivative work of all or part of

CertList 1.85

which is governed by the following license terms and conditions:

=====  
This Source Code Form is subject to the terms of the Mozilla Public License, v. 2.0. If a copy of the MPL was not distributed with this file, You can obtain one at <http://mozilla.org/MPL/2.0/>.  
=====

=====  
This product may include derivative work of all or part of

libwebp 0.4.3

which is governed by the following license terms and conditions:

=====  
Copyright (c) 2010, Google Inc. All rights reserved.

Redistribution and use in source and binary forms, with or without modification, are permitted provided that the following conditions are met:

- \* Redistributions of source code must retain the above copyright notice, this list of conditions and the following disclaimer.
- \* Redistributions in binary form must reproduce the above copyright notice, this list of conditions and the following disclaimer in the documentation and/or other materials provided with the distribution.
- \* Neither the name of Google nor the names of its contributors may be used to endorse or promote products derived from this software without specific prior written permission.

=====  
THIS SOFTWARE IS PROVIDED BY THE COPYRIGHT HOLDERS AND CONTRIBUTORS "AS IS" AND ANY EXPRESS OR IMPLIED WARRANTIES, INCLUDING, BUT NOT LIMITED TO, THE IMPLIED WARRANTIES OF MERCHANTABILITY AND FITNESS FOR A PARTICULAR PURPOSE ARE DISCLAIMED. IN NO EVENT SHALL THE COPYRIGHT HOLDER OR CONTRIBUTORS BE LIABLE FOR ANY DIRECT, INDIRECT, INCIDENTAL, SPECIAL, EXEMPLARY, OR CONSEQUENTIAL DAMAGES (INCLUDING, BUT NOT LIMITED TO, PROCUREMENT OF SUBSTITUTE GOODS OR SERVICES; LOSS OF USE, DATA, OR PROFITS; OR BUSINESS INTERRUPTION) HOWEVER CAUSED AND ON ANY THEORY OF LIABILITY, WHETHER IN CONTRACT, STRICT LIABILITY, OR TORT (INCLUDING NEGLIGENCE OR OTHERWISE) ARISING IN ANY WAY OUT OF THE USE OF THIS SOFTWARE, EVEN IF ADVISED OF THE POSSIBILITY OF SUCH DAMAGE.  
=====

=====  
This product may include derivative work of all or part of

c-ares version 1.10.0

which is governed by the following license terms and conditions:

=====  
c-ares license

Copyright 1998 by the Massachusetts Institute of Technology.

Permission to use, copy, modify, and distribute this software and its documentation for any purpose and without fee is hereby granted, provided that the above copyright notice appear in all copies and that both that copyright notice and this permission notice appear in supporting documentation, and that the name of M.I.T. not be used in advertising or publicity pertaining to distribution of the software without specific, written prior permission. M.I.T. makes no representations about the suitability of this software for any purpose. It is provided "as is" without express or implied warranty.

=====  
c-ares version 1.10.0

Changes:

- o Added `ares_create_query()`, to be used instead of `ares_mkquery()`
- o `ares_inet_ntop()` and `ares_inet_pton()` are now recognized c-ares functions

Bug fixes:

- o include the `ares_parse_soa_reply.*` files in the tarball

```
o read_udp_packets: bail out loop on bad sockets
o get_DNS_AdaptersAddresses: fix IPv6 parsing
o adlg: perror() doesn't work for socket errors on windows
o ares_parse_aaaa_reply: fix memory leak
o setup_once.h: HP-UX <sys/socket.h> issue workaround
o configure: several fixes
o config-dos.h: define strerror() to strerror_s() for High-C
o config-dos.h: define HAVE_CLOSE_S for MSDOS/Watt-32
o ares_build.h.dist: enhance non-configure GCC ABI detection logic
o ares.h: stricter CARES_EXTERN linkage decorations logic
o ares_cancel(): cancel requests safely
o protocol parsing: check input data stricter
o library init: be recursive, reference count inits/cleanups
o ares_parse_txt_reply: return a ares_txt_reply node for each sub-string
o ares_set_servers_csv: fixed IPv6 address parsing
o build: fix build on msvc11
```

Thanks go to these friendly people for their efforts and contributions:

Eugeny Gladkih, Yang Tse, Gisle Vanem, Guenter Knauf, Horatiu Popescu, Alexander Klauer, Patrick Valsecchi, Paul Saab, Keith Shaw, Alex Loukissas

Have fun!

This product may include derivative work of all or part of

SQLite version 3.7.6.3

which is governed by the following license terms and conditions:

```
** This file is an amalgamation of many separate C source files from SQLite
** version 3.7.6.3. By combining all the individual C code files into this
** single large file, the entire code can be compiled as a single translation
** unit. This allows many compilers to do optimizations that would not be
** possible if the files were compiled separately. Performance improvements
** of 5% or more are commonly seen when SQLite is compiled as a single
** translation unit.
**
** This file is all you need to compile SQLite. To use SQLite in other
** programs, you need this file and the "sqlite3.h" header file that defines
** the programming interface to the SQLite library. (If you do not have
** the "sqlite3.h" header file at hand, you will find a copy embedded within
** the text of this file. Search for "Begin file sqlite3.h" to find the start
** of the embedded sqlite3.h header file.) Additional code files may be needed
** if you want a wrapper to interface SQLite with your choice of programming
** language. The code for the "sqlite3" command-line shell is also in a
** separate file. This file contains only code for the core SQLite library.
```

This product may include derivative work of all or part of

libjpeg-turbo version 1.3.0

which is governed by the following license terms and conditions:

```
**** Background
*****
```

libjpeg-turbo is a JPEG image codec that uses SIMD instructions (MMX, SSE2, NEON) to accelerate both JPEG compression and decompression on x86, x86-64, and ARM systems. On such systems, libjpeg-turbo is generally 2-4x as fast as libjpeg, all else being equal. On other types of systems, libjpeg-turbo can still outperform libjpeg by a significant amount, by virtue of its highly-optimized Huffman coding routines. In many cases, the performance of libjpeg-turbo rivals that of proprietary high-speed JPEG codecs.

libjpeg-turbo implements both the traditional libjpeg API as well as the less powerful but more straightforward TurboJPEG API. libjpeg-turbo also features colorspace extensions that allow it to compress from/decompress to 32-bit and big-endian pixel buffers (RGBX, XBGR, etc.), as well as a full-featured Java interface.

libjpeg-turbo was originally based on libjpeg/SIMD, an MMX-accelerated derivative of libjpeg v6b developed by Miyasaka Masaru. The TigerVNC and VirtualGL projects made numerous enhancements to the codec in 2009, and in early 2010, libjpeg-turbo spun off into an independent project, with the goal of making high-speed JPEG compression/decompression technology available to a broader range of users and developers.

```
**** License
*****
```

Most of libjpeg-turbo inherits the non-restrictive, BSD-style license used by libjpeg (see README). The TurboJPEG wrapper (both C and Java versions) and associated test programs bear a similar license, which is reproduced below:

Redistribution and use in source and binary forms, with or without modification, are permitted provided that the following conditions are met:

- Redistributions of source code must retain the above copyright notice, this list of conditions and the following disclaimer.
- Redistributions in binary form must reproduce the above copyright notice, this list of conditions and the following disclaimer in the documentation and/or other materials provided with the distribution.
- Neither the name of the libjpeg-turbo Project nor the names of its contributors may be used to endorse or promote products derived from this software without specific prior written permission.

THIS SOFTWARE IS PROVIDED BY THE COPYRIGHT HOLDERS AND CONTRIBUTORS "AS IS", AND ANY EXPRESS OR IMPLIED WARRANTIES, INCLUDING, BUT NOT LIMITED TO, THE IMPLIED WARRANTIES OF MERCHANTABILITY AND FITNESS FOR A PARTICULAR PURPOSE ARE DISCLAIMED. IN NO EVENT SHALL THE COPYRIGHT HOLDERS OR CONTRIBUTORS BE LIABLE FOR ANY DIRECT, INDIRECT, INCIDENTAL, SPECIAL, EXEMPLARY, OR CONSEQUENTIAL DAMAGES (INCLUDING, BUT NOT LIMITED TO, PROCUREMENT OF SUBSTITUTE GOODS OR SERVICES; LOSS OF USE, DATA, OR PROFITS; OR BUSINESS INTERRUPTION) HOWEVER CAUSED AND ON ANY THEORY OF LIABILITY, WHETHER IN CONTRACT, STRICT LIABILITY, OR TORT (INCLUDING NEGLIGENCE OR OTHERWISE) ARISING IN ANY WAY OUT OF THE USE OF THIS SOFTWARE, EVEN IF ADVISED OF THE POSSIBILITY OF SUCH DAMAGE.

```
**** Using libjpeg-turbo
*****
```

libjpeg-turbo includes two APIs that can be used to compress and decompress JPEG images:

TurboJPEG API: This API provides an easy-to-use interface for compressing and decompressing JPEG images in memory. It also provides some functionality

that would not be straightforward to achieve using the underlying libjpeg API, such as generating planar YUV images and performing multiple simultaneous lossless transforms on an image. The Java interface for libjpeg-turbo is written on top of the TurboJPEG API.

libjpeg API: This is the de facto industry-standard API for compressing and decompressing JPEG images. It is more difficult to use than the TurboJPEG API but also more powerful. The libjpeg API implementation in libjpeg-turbo is both API/ABI-compatible and mathematically compatible with libjpeg v6b. It can also optionally be configured to be API/ABI-compatible with libjpeg v7 and v8 (see below).

There is no significant performance advantage to either API when both are used to perform similar operations.

#### Installation Directory

This document assumes that libjpeg-turbo will be installed in the default directory (/opt/libjpeg-turbo on Un\*x and Mac systems and c:\libjpeg-turbo-gcc[64] on Windows systems. If your installation of libjpeg-turbo resides in a different directory, then adjust the instructions accordingly.

#### Replacing libjpeg at Run Time

##### Un\*x

If a Un\*x application is dynamically linked with libjpeg, then you can replace libjpeg with libjpeg-turbo at run time by manipulating LD\_LIBRARY\_PATH. For instance:

```
[Using libjpeg]
> time cjpeg <vgl_5674_0098.ppm >vgl_5674_0098.jpg
real 0m0.392s
user 0m0.074s
sys 0m0.020s
```

```
[Using libjpeg-turbo]
> export LD_LIBRARY_PATH=/opt/libjpeg-turbo/lib:$LD_LIBRARY_PATH
> time cjpeg <vgl_5674_0098.ppm >vgl_5674_0098.jpg
real 0m0.109s
user 0m0.029s
sys 0m0.010s
```

(lib) = lib32 or lib64, depending on whether you wish to use the 32-bit or the 64-bit version of libjpeg-turbo.)

System administrators can also replace the libjpeg symlinks in /usr/lib\* with links to the libjpeg-turbo dynamic library located in /opt/libjpeg-turbo/lib. This will effectively accelerate every application that uses the libjpeg dynamic library on the system.

##### Windows

If a Windows application is dynamically linked with libjpeg, then you can replace libjpeg with libjpeg-turbo at run time by backing up the application's copy of jpeg62.dll, jpeg7.dll, or jpeg8.dll (assuming the application has its own local copy of this library) and copying the corresponding DLL from libjpeg-turbo into the application's install directory. The official libjpeg-turbo binary packages only provide jpeg62.dll. If the application uses jpeg7.dll or jpeg8.dll instead, then it will be necessary to build libjpeg-turbo from source (see "libjpeg v7 and v8 API/ABI Emulation" below.)

The following information is specific to the official libjpeg-turbo binary packages for Visual C++:

-- jpeg62.dll requires the Visual C++ 2008 C run-time DLL (msvcr90.dll). msvc90.dll ships with more recent versions of Windows, but users of older Windows releases can obtain it from the Visual C++ 2008 Redistributable Package, which is available as a free download from Microsoft's web site.

-- Features of the libjpeg API that require passing a C run-time structure, such as a file handle, from an application to the library will probably not work with jpeg62.dll, unless the application is also built to use the Visual C++ 2008 C run-time DLL. In particular, this affects jpeg\_stdio\_dest() and jpeg\_stdio\_src().

##### Mac

Mac applications typically embed their own copies of the libjpeg dylib inside the (hidden) application bundle, so it is not possible to globally replace libjpeg on OS X systems. Replacing the application's version of the libjpeg dylib would generally involve copying libjpeg.\*.dylib from libjpeg-turbo into the appropriate place in the application bundle and using install\_name\_tool to repoint the libjpeg-turbo dylib to its new directory. This requires an advanced knowledge of OS X and would not survive an upgrade or a re-install of the application. Thus, it is not recommended for most users.

#### Using libjpeg-turbo in Your Own Programs

For the most part, libjpeg-turbo should work identically to libjpeg, so in most cases, an application can be built against libjpeg and then run against libjpeg-turbo. On Un\*x systems and Cygwin, you can build against libjpeg-turbo instead of libjpeg by setting

```
CPATH=/opt/libjpeg-turbo/include
and
LIBRARY_PATH=/opt/libjpeg-turbo/lib
```

(lib) = lib32 or lib64, depending on whether you are building a 32-bit or a 64-bit application.)

If using MinGW, then set

```
CPATH=/c:/libjpeg-turbo-gcc[64]/include
and
LIBRARY_PATH=/c:/libjpeg-turbo-gcc[64]/lib
```

Building against libjpeg-turbo is useful, for instance, if you want to build an application that leverages the libjpeg-turbo colorspace extensions (see below.) On Un\*x systems, you would still need to manipulate LD\_LIBRARY\_PATH or create appropriate symlinks to use libjpeg-turbo at run time. On such systems, you can pass -R /opt/libjpeg-turbo/lib to the linker to force the use of libjpeg-turbo at run time rather than libjpeg (also useful if you want to leverage the colorspace extensions), or you can link against the libjpeg-turbostatic library.

To force a Un\*x or MinGW application to link against the static version of libjpeg-turbo, you can use the following linker options:

```
-Wl,-Bstatic -ljpeg -Wl,-Bdynamic
```

On OS X, simply add /opt/libjpeg-turbo/lib/libjpeg.a to the linker command line.

To build Visual C++ applications using libjpeg-turbo, add c:\libjpeg-turbo[64]\include to the system or user INCLUDE environment variable and c:\libjpeg-turbo[64]\lib to the system or user LIB environment variable, and then link against either jpeg.lib (to use the DLL version of libjpeg-turbo) or jpeg-static.lib (to use the static version of libjpeg-turbo.)

# 本機で使われるソフトウェアライセンス情報 (つづき)

## ===== Colorspace Extensions =====

libjpeg-turbo includes extensions that allow JPEG images to be compressed directly from (and decompressed directly to) buffers that use BGR, BGRX, RGBX, XBGR, and XRGB pixel ordering. This is implemented with ten new colorspace constants:

```
JCS_EXT_RGB /* red/green/blue */
JCS_EXT_RGBX /* red/green/blue/x */
JCS_EXT_BGR /* blue/green/red */
JCS_EXT_BGRX /* blue/green/red/x */
JCS_EXT_XBGR /* x/blue/green/red */
JCS_EXT_XBGRX /* x/blue/green/red/x */
JCS_EXT_XRGB /* x/red/green/blue */
JCS_EXT_XRGBX /* x/red/green/blue/x */
JCS_EXT_RGBA /* red/green/blue/alpha */
JCS_EXT_BGRA /* blue/green/red/alpha */
JCS_EXT_ABGR /* alpha/blue/green/red */
JCS_EXT_ARGB /* alpha/red/green/blue */
```

Setting `cinfo.in_color_space` (compression) or `cinfo.out_color_space` (decompression) to one of these values will cause libjpeg-turbo to read the red, green, and blue values from (or write them to) the appropriate position in the pixel when compressing from/decompressing to an RGB buffer.

Your application can check for the existence of these extensions at compile time with:

```
#ifdef JCS_EXTENSIONS
```

At run time, attempting to use these extensions with a libjpeg implementation that does not support them will result in a "Bogus input colorspace" error. Applications can trap this error in order to test whether run-time support is available for the colorspace extensions.

When using the RGBX, BGRX, XBGR, and XRGB colorspace during decompression, the X byte is undefined, and in order to ensure the best performance, libjpeg-turbo can set that byte to whatever value it wishes. If an application expects the X byte to be used as an alpha channel, then it should specify JCS\_EXT\_RGBA, JCS\_EXT\_BGRA, JCS\_EXT\_ABGR, or JCS\_EXT\_ARGB. When these colorspace constants are used, the X byte is guaranteed to be 0xFF, which is interpreted as opaque.

Your application can check for the existence of the alpha channel colorspace extensions at compile time with:

```
#ifdef JCS_ALPHA_EXTENSIONS
```

`jcstest.c`, located in the libjpeg-turbo source tree, demonstrates how to check for the existence of the colorspace extensions at compile time and run time.

## ===== libjpeg v7 and v8 API/ABI Emulation =====

With libjpeg v7 and v8, new features were added that necessitated extending the compression and decompression structures. Unfortunately, due to the exposed nature of those structures, extending them also necessitated breaking backward ABI compatibility with previous libjpeg releases. Thus, programs that were built to use libjpeg v7 or v8 did not work with libjpeg-turbo, since it is based on the libjpeg v6b code base. Although libjpeg v7 and v8 are still not as widely used as v6b, enough programs (including a few Linux distros) made the switch that there was a demand to emulate the libjpeg v7 and v8 ABIs in libjpeg-turbo. It should be noted, however, that this feature was added primarily so that applications that had already been compiled to use libjpeg v7+ could take advantage of accelerated baseline JPEG encoding/decoding without recompiling. libjpeg-turbo does not claim to support all of the libjpeg v7+ features, nor to produce identical output to libjpeg v7+ in all cases (see below).

By passing an argument of `--with-jpeg7` or `--with-jpeg8` to configure, or an argument of `-DWITH_JPEG7=1` or `-DWITH_JPEG8=1` to cmake, you can build a version of libjpeg-turbo that emulates the libjpeg v7 or v8 ABI, so that programs that are built against libjpeg v7 or v8 can be run with libjpeg-turbo. The following section describes which libjpeg v7+ features are supported and which aren't.

### Support for libjpeg v7 and v8 Features:

Fully supported:

- libjpeg: IDCT scaling extensions in decompressor  
libjpeg-turbo supports IDCT scaling with scaling factors of 1/8, 1/4, 3/8, 1/2, 5/8, 3/4, 7/8, 9/8, 5/4, 11/8, 3/2, 13/8, 7/4, 15/8, and 2/1 (only 1/4 and 1/2 are SIMD-accelerated.)
- libjpeg: arithmetic coding
- libjpeg: In-memory source and destination managers  
See notes below.
- cjpeg: Separate quality settings for luminance and chrominance.  
Note that the libjpeg v7+ API was extended to accommodate this feature only for convenience purposes. It has always been possible to implement this feature with libjpeg v6b (see `rdswitch.c` for an example.)
- cjpeg: 32-bit BMP support
- cjpeg: -rgb option
- jpegtran: lossless cropping
- jpegtran: -perfect option
- jpegtran: forcing width/height when performing lossless crop
- rdjpgcom: -raw option
- rdjpgcom: locale awareness

Not supported:

NOTE: As of this writing, extensive research has been conducted into the usefulness of DCT scaling as a means of data reduction and SmartScale as a means of quality improvement. The reader is invited to peruse the research at <http://www.libjpeg-turbo.org/About/SmartScale> and draw his/her own conclusions, but it is the general belief of our project that these features have not demonstrated sufficient usefulness to justify inclusion in libjpeg-turbo.

- libjpeg: DCT scaling in compressor  
`cinfo.scale_num` and `cinfo.scale_denom` are silently ignored.  
There is no technical reason why DCT scaling could not be supported when emulating the libjpeg v7+ API/ABI, but without the SmartScale extension (see below), only scaling factors of 1/2, 8/15, 4/7, 8/13, 2/3, 8/11, 4/5, and 8/9 would be available, which is of limited usefulness.
- libjpeg: SmartScale  
`cinfo.block_size` is silently ignored.  
SmartScale is an extension to the JPEG format that allows for DCT block sizes other than 8x8. Providing support for this new format would be feasible (particularly without full acceleration). However, until/unless the format becomes either an official industry standard or, at minimum, an accepted solution in the community, we are hesitant to implement it, as there is no sense of whether or how it might change in the future. It is our belief that SmartScale has not demonstrated sufficient usefulness as a lossless format nor as a means of quality enhancement, and thus, our primary interest in providing this feature would be as a means of supporting

additional DCT scaling factors.

- libjpeg: Fancy downsampling in compressor  
`cinfo.do_fancy_downsampling` is silently ignored.  
This requires the DCT scaling feature, which is not supported.
- jpegtran: Scaling  
This requires both the DCT scaling and SmartScale features, which are not supported.
- Lossless RGB JPEG files  
This requires the SmartScale feature, which is not supported.

### What About libjpeg v9?

libjpeg v9 introduced yet another field to the JPEG compression structure (`color_transform`), thus making the ABI backward incompatible with that of libjpeg v8. This new field was introduced solely for the purpose of supporting lossless SmartScale encoding. Further, there was actually no reason to extend the API in this manner, as the `color_transform` could have just as easily been activated by way of a new JPEG colorspace constant, thus preserving backward ABI compatibility.

Our research (see link above) has shown that lossless SmartScale does not generally accomplish anything that can't already be accomplished better with existing, standard lossless formats. Thus, at this time, it is our belief that there is not sufficient technical justification for software to upgrade from libjpeg v8 to libjpeg v9, and therefore, not sufficient technical justification for us to emulate the libjpeg v9 ABI.

## ===== In-Memory Source/Destination Managers =====

By default, libjpeg-turbo 1.3 and later includes the `jpeg_mem_src()` and `jpeg_mem_dest()` functions, even when not emulating the libjpeg v8 API/ABI. Previously, it was necessary to build libjpeg-turbo from source with libjpeg v8 API/ABI emulation in order to use the in-memory source/destination managers, but several projects requested that those functions be included when emulating the libjpeg v6b API/ABI as well. This allows the use of those functions by programs that need them without breaking ABI compatibility for programs that don't, and it allows those functions to be provided in the "official" libjpeg-turbo binaries.

Those who are concerned about maintaining strict conformance with the libjpeg v6b or v7 API can pass an argument of `--without-mem-srcdst` to configure or an argument of `-DWITH_MEM_SRCDEST=0` to CMake prior to building libjpeg-turbo. This will restore the pre-1.3 behavior, in which `jpeg_mem_src()` and `jpeg_mem_dest()` are only included when emulating the libjpeg v8 API/ABI.

On Un\*x systems, including the in-memory source/destination managers changes the dynamic library version from 62.0.0 to 62.1.0 if using libjpeg v6b API/ABI emulation and from 7.0.0 to 7.1.0 if using libjpeg v7 API/ABI emulation.

Note that, on most Un\*x systems, the dynamic linker will not look for a function in a library until that function is actually used. Thus, if a program is built against libjpeg-turbo 1.3+ and uses `jpeg_mem_src()` or `jpeg_mem_dest()`, that program will not fail if run against an older version of libjpeg-turbo or against libjpeg v7- until the program actually tries to call `jpeg_mem_src()` or `jpeg_mem_dest()`. Such is not the case on Windows. If a program is built against the libjpeg-turbo 1.3+ DLL and uses `jpeg_mem_src()` or `jpeg_mem_dest()`, then it must use the libjpeg-turbo 1.3+ DLL at run time.

Both `cjpeg` and `djpeg` have been extended to allow testing the in-memory source/destination manager functions. See their respective man pages for more details.

## ===== \*\* Mathematical Compatibility =====

For the most part, libjpeg-turbo should produce identical output to libjpeg v6b. The one exception to this is when using the floating point DCT/IDCT, in which case the outputs of libjpeg v6b and libjpeg-turbo are not guaranteed to be identical (the accuracy of the floating point DCT/IDCT is constant when using libjpeg-turbo's SIMD extensions, but otherwise, it can depend heavily on the compiler and compiler settings.)

While libjpeg-turbo does emulate the libjpeg v8 API/ABI, under the hood, it is still using the same algorithms as libjpeg v6b, so there are several specific cases in which libjpeg-turbo cannot be expected to produce the same output as libjpeg v8:

- When decompressing using scaling factors of 1/2 and 1/4, because libjpeg v8 implements those scaling algorithms a bit differently than libjpeg v6b does, and libjpeg-turbo's SIMD extensions are based on the libjpeg v6b behavior.
- When using chrominance subsampling, because libjpeg v8 implements this with its DCT/IDCT scaling algorithms rather than with a separate downsampling/upsampling algorithm.
- When using the floating point IDCT, for the reasons stated above and also because the floating point IDCT algorithm was modified in libjpeg v8a to improve accuracy.
- When decompressing using a scaling factor > 1 and merged (AKA "non-fancy" or "non-smooth") chrominance upsampling, because libjpeg v8 does not support merged upsampling with scaling factors > 1.

## ===== \*\* Performance Pitfalls =====

### ===== Restart Markers =====

The optimized Huffman decoder in libjpeg-turbo does not handle restart markers in a way that makes the rest of the libjpeg infrastructure happy, so it is necessary to use the slow Huffman decoder when decompressing a JPEG image that has restart markers. This can cause the decompression performance to drop by as much as 20%, but the performance will still be much greater than that of libjpeg. Many consumer packages, such as Photoshop, use restart markers when generating JPEG images, so images generated by those programs will experience this issue.

### ===== Fast Integer Forward DCT at High Quality Levels =====

The algorithm used by the SIMD-accelerated quantization function cannot produce correct results whenever the fast integer forward DCT is used along with a JPEG quality of 98-100. Thus, libjpeg-turbo must use the non-SIMD quantization function in those cases. This causes performance to drop by as much as 40%. It is therefore strongly advised that you use the slow integer forward DCT whenever encoding images with a JPEG quality of 98 or higher.

=====  
This product may include derivative work of all or part of

Backbone v0.9.2

which is governed by the following license terms and conditions:

Copyright (c) 2010-2012 Jeremy Ashkenas, DocumentCloud

Permission is hereby granted, free of charge, to any person obtaining a copy of this software and associated documentation files (the "Software"), to deal in the Software without restriction, including without limitation the rights to use, copy, modify, merge, publish, distribute, sublicense, and/or sell copies of the Software, and to permit persons to whom the Software is furnished to do so, subject to the following conditions:

The above copyright notice and this permission notice shall be included in all copies or substantial portions of the Software.

THE SOFTWARE IS PROVIDED "AS IS", WITHOUT WARRANTY OF ANY KIND, EXPRESS OR IMPLIED, INCLUDING BUT NOT LIMITED TO THE WARRANTIES OF MERCHANTABILITY, FITNESS FOR A PARTICULAR PURPOSE AND NONINFRINGEMENT. IN NO EVENT SHALL THE AUTHORS OR COPYRIGHT HOLDERS BE LIABLE FOR ANY CLAIM, DAMAGES OR OTHER LIABILITY, WHETHER IN AN ACTION OF CONTRACT, TORT OR OTHERWISE, ARISING FROM, OUT OF OR IN CONNECTION WITH THE SOFTWARE OR THE USE OR OTHER DEALINGS IN THE SOFTWARE.

=====

This product may include derivative work of all or part of

Bootstrap v2.0.4

which is governed by the following license terms and conditions:

Apache License  
Version 2.0, January 2004  
<http://www.apache.org/licenses/>

TERMS AND CONDITIONS FOR USE, REPRODUCTION, AND DISTRIBUTION

1. Definitions.

"License" shall mean the terms and conditions for use, reproduction, and distribution as defined by Sections 1 through 9 of this document.

"Licensor" shall mean the copyright owner or entity authorized by the copyright owner that is granting the License.

"Legal Entity" shall mean the union of the acting entity and all other entities that control, are controlled by, or are under common control with that entity. For the purposes of this definition, "control" means (i) the power, direct or indirect, to cause the direction or management of such entity, whether by contract or otherwise, or (ii) ownership of fifty percent (50%) or more of the outstanding shares, or (iii) beneficial ownership of such entity.

"You" (or "Your") shall mean an individual or Legal Entity exercising permissions granted by this License.

"Source" form shall mean the preferred form for making modifications, including but not limited to software source code, documentation source, and configuration files.

"Object" form shall mean any form resulting from mechanical transformation or translation of a Source form, including but not limited to compiled object code, generated documentation, and conversions to other media types.

"Work" shall mean the work of authorship, whether in Source or Object form, made available under the License, as indicated by a copyright notice that is included in or attached to the work (an example is provided in the Appendix below).

"Derivative Works" shall mean any work, whether in Source or Object form, that is based on (or derived from) the Work and for which the editorial revisions, annotations, elaborations, or other modifications represent, as a whole, an original work of authorship. For the purposes of this License, Derivative Works shall not include works that remain separable from, or merely link (or bind by name) to the interfaces of, the Work and Derivative Works thereof.

"Contribution" shall mean any work of authorship, including the original version of the Work and any modifications or additions to that Work or Derivative Works thereof, that is intentionally submitted to Licensor for inclusion in the Work by the copyright owner or by an individual or Legal Entity authorized to submit on behalf of the copyright owner. For the purposes of this definition, "submitted" means any form of electronic, verbal, or written communication sent to the Licensor or its representatives, including but not limited to communication on electronic mailing lists, source code control systems, and issue tracking systems that are managed by, or on behalf of, the Licensor for the purpose of discussing and improving the Work, but excluding communication that is conspicuously marked or otherwise designated in writing by the copyright owner as "Not a Contribution."

"Contributor" shall mean Licensor and any individual or Legal Entity on behalf of whom a Contribution has been received by Licensor and subsequently incorporated within the Work.

2. Grant of Copyright License. Subject to the terms and conditions of this License, each Contributor hereby grants to You a perpetual, worldwide, non-exclusive, no-charge, royalty-free, irrevocable copyright license to reproduce, prepare Derivative Works of, publicly display, publicly perform, sublicense, and distribute the Work and such Derivative Works in Source or Object form.

3. Grant of Patent License. Subject to the terms and conditions of this License, each Contributor hereby grants to You a perpetual, worldwide, non-exclusive, no-charge, royalty-free, irrevocable (except as stated in this section) patent license to make, have made, use, offer to sell, sell, import, and otherwise transfer the Work, where such license applies only to those patent claims licensable by such Contributor that are necessarily infringed by their Contribution(s) alone or by combination of their Contribution(s) with the Work to which such Contribution(s) was submitted. If You institute patent litigation against any entity (including a cross-claim or counterclaim in a lawsuit) alleging that the Work or a Contribution incorporated within the Work constitutes direct or contributory patent infringement, then any patent licenses granted to You under this License for that Work shall terminate as of the date such litigation is filed.

4. Redistribution. You may reproduce and distribute copies of the Work or Derivative Works thereof in any medium, with or without modifications, and in Source or Object form, provided that You meet the following conditions:

- (a) You must give any other recipients of the Work or Derivative Works a copy of this License; and
- (b) You must cause any modified files to carry prominent notices stating that You changed the files; and
- (c) You must retain, in the Source form of any Derivative Works

that You distribute, all copyright, patent, trademark, and attribution notices from the Source form of the Work, excluding those notices that do not pertain to any part of the Derivative Works; and

(d) If the Work includes a "NOTICE" text file as part of its distribution, then any Derivative Works that You distribute must include a readable copy of the attribution notices contained within such NOTICE file, excluding those notices that do not pertain to any part of the Derivative Works, in at least one of the following places: within a NOTICE text file distributed as part of the Derivative Works; within the Source form or documentation, if provided along with the Derivative Works; or, within a display generated by the Derivative Works, if and wherever such third-party notices normally appear. The contents of the NOTICE file are for informational purposes only and do not modify the License. You may add Your own attribution notices within Derivative Works that You distribute, alongside or as an addendum to the NOTICE text from the Work, provided that such additional attribution notices cannot be construed as modifying the License.

You may add Your own copyright statement to Your modifications and may provide additional or different license terms and conditions for use, reproduction, or distribution of Your modifications, or for any such Derivative Works as a whole, provided Your use, reproduction, and distribution of the Work otherwise complies with the conditions stated in this License.

5. Submission of Contributions. Unless You explicitly state otherwise, any Contribution intentionally submitted for inclusion in the Work by You to the Licensor shall be under the terms and conditions of this License, without any additional terms or conditions. Notwithstanding the above, nothing herein shall supersede or modify the terms of any separate license agreement you may have executed with Licensor regarding such Contributions.

6. Trademarks. This License does not grant permission to use the trade names, trademarks, service marks, or product names of the Licensor, except as required for reasonable and customary use in describing the origin of the Work and reproducing the content of the NOTICE file.

7. Disclaimer of Warranty. Unless required by applicable law or agreed to in writing, Licensor provides the Work (and each Contributor provides its Contributions) on an "AS IS" BASIS, WITHOUT WARRANTIES OR CONDITIONS OF ANY KIND, either express or implied, including, without limitation, any warranties or conditions of TITLE, NON-INFRINGEMENT, MERCHANTABILITY, or FITNESS FOR A PARTICULAR PURPOSE. You are solely responsible for determining the appropriateness of using or redistributing the Work and assume any risks associated with Your exercise of permissions under this License.

8. Limitation of Liability. In no event and under no legal theory, whether in tort (including negligence), contract, or otherwise, unless required by applicable law (such as deliberate and grossly negligent acts) or agreed to in writing, shall any Contributor be liable to You for damages, including any direct, indirect, special, incidental, or consequential damages of any character arising as a result of this License or out of the use or inability to use the Work (including but not limited to damages for loss of goodwill, work stoppage, computer failure or malfunction, or any and all other commercial damages or losses), even if such Contributor has been advised of the possibility of such damages.

9. Accepting Warranty or Additional Liability. While redistributing the Work or Derivative Works thereof, You may choose to offer, and charge a fee for, acceptance of support, warranty, indemnity, or other liability obligations and/or rights consistent with this License. However, in accepting such obligations, You may act only on Your own behalf and on Your sole responsibility, not on behalf of any other Contributor, and only if You agree to indemnify, defend, and hold each Contributor harmless for any liability incurred by, or claims asserted against, such Contributor by reason of your accepting any such warranty or additional liability.

END OF TERMS AND CONDITIONS

=====

This product may include derivative work of all or part of

Glyphicons v1.7

which is governed by the following license terms and conditions:

Copyright 2012 Jan Kovařík

Licensed under the Apache License, Version 2.0 (the "License"); you may not use this file except in compliance with the License. You may obtain a copy of the License at <http://www.apache.org/licenses/LICENSE-2.0> Unless required by applicable law or agreed to in writing, software distributed under the License is distributed on an "AS IS" BASIS, WITHOUT WARRANTIES OR CONDITIONS OF ANY KIND, either express or implied. See the License for the specific language governing permissions and limitations under the License.

=====

This product may include derivative work of all or part of

jQuery v1.9.0

which is governed by the following license terms and conditions:

Copyright 2013 jQuery Foundation and other contributors  
<http://jquery.com/>

Permission is hereby granted, free of charge, to any person obtaining a copy of this software and associated documentation files (the "Software"), to deal in the Software without restriction, including without limitation the rights to use, copy, modify, merge, publish, distribute, sublicense, and/or sell copies of the Software, and to permit persons to whom the Software is furnished to do so, subject to the following conditions:

The above copyright notice and this permission notice shall be included in all copies or substantial portions of the Software.

THE SOFTWARE IS PROVIDED "AS IS", WITHOUT WARRANTY OF ANY KIND, EXPRESS OR IMPLIED, INCLUDING BUT NOT LIMITED TO THE WARRANTIES OF MERCHANTABILITY, FITNESS FOR A PARTICULAR PURPOSE AND NONINFRINGEMENT. IN NO EVENT SHALL THE AUTHORS OR COPYRIGHT HOLDERS BE LIABLE FOR ANY CLAIM, DAMAGES OR OTHER LIABILITY, WHETHER IN AN ACTION OF CONTRACT, TORT OR OTHERWISE, ARISING FROM, OUT OF OR IN CONNECTION WITH THE SOFTWARE OR THE USE OR OTHER DEALINGS IN THE SOFTWARE.

=====

This product may include derivative work of all or part of

# 本機で使われるソフトウェアライセンス情報 (つづき)

jGrowl v1.2.6

which is governed by the following license terms and conditions:

MIT License

Copyright (c) 2011 Stan Lemon

Permission is hereby granted, free of charge, to any person obtaining a copy of this software and associated documentation files (the "Software"), to deal in the Software without restriction, including without limitation the rights to use, copy, modify, merge, publish, distribute, sublicense, and/or sell copies of the Software, and to permit persons to whom the Software is furnished to do so, subject to the following conditions:

The above copyright notice and this permission notice shall be included in all copies or substantial portions of the Software.

THE SOFTWARE IS PROVIDED "AS IS", WITHOUT WARRANTY OF ANY KIND, EXPRESS OR IMPLIED, INCLUDING BUT NOT LIMITED TO THE WARRANTIES OF MERCHANTABILITY, FITNESS FOR A PARTICULAR PURPOSE AND NONINFRINGEMENT. IN NO EVENT SHALL THE AUTHORS OR COPYRIGHT HOLDERS BE LIABLE FOR ANY CLAIM, DAMAGES OR OTHER LIABILITY, WHETHER IN AN ACTION OF CONTRACT, TORT OR OTHERWISE, ARISING FROM, OUT OF OR IN CONNECTION WITH THE SOFTWARE OR THE USE OR OTHER DEALINGS IN THE SOFTWARE.

=====  
=====

This product may include derivative work of all or part of

RequireJS v2.1.4

which is governed by the following license terms and conditions:

MIT License

Copyright (c) 2010-2011, The Dojo Foundation

Permission is hereby granted, free of charge, to any person obtaining a copy of this software and associated documentation files (the "Software"), to deal in the Software without restriction, including without limitation the rights to use, copy, modify, merge, publish, distribute, sublicense, and/or sell copies of the Software, and to permit persons to whom the Software is furnished to do so, subject to the following conditions:

The above copyright notice and this permission notice shall be included in all copies or substantial portions of the Software.

THE SOFTWARE IS PROVIDED "AS IS", WITHOUT WARRANTY OF ANY KIND, EXPRESS OR IMPLIED, INCLUDING BUT NOT LIMITED TO THE WARRANTIES OF MERCHANTABILITY, FITNESS FOR A PARTICULAR PURPOSE AND NONINFRINGEMENT. IN NO EVENT SHALL THE AUTHORS OR COPYRIGHT HOLDERS BE LIABLE FOR ANY CLAIM, DAMAGES OR OTHER LIABILITY, WHETHER IN AN ACTION OF CONTRACT, TORT OR OTHERWISE, ARISING FROM, OUT OF OR IN CONNECTION WITH THE SOFTWARE OR THE USE OR OTHER DEALINGS IN THE SOFTWARE.

=====  
=====

This product may include derivative work of all or part of

Underscore v1.4.4

which is governed by the following license terms and conditions:

Copyright (c) 2009-2012 Jeremy Ashkenas, DocumentCloud

Permission is hereby granted, free of charge, to any person obtaining a copy of this software and associated documentation files (the "Software"), to deal in the Software without restriction, including without limitation the rights to use, copy, modify, merge, publish, distribute, sublicense, and/or sell copies of the Software, and to permit persons to whom the Software is furnished to do so, subject to the following conditions:

The above copyright notice and this permission notice shall be included in all copies or substantial portions of the Software.

THE SOFTWARE IS PROVIDED "AS IS", WITHOUT WARRANTY OF ANY KIND, EXPRESS OR IMPLIED, INCLUDING BUT NOT LIMITED TO THE WARRANTIES OF MERCHANTABILITY, FITNESS FOR A PARTICULAR PURPOSE AND NONINFRINGEMENT. IN NO EVENT SHALL THE AUTHORS OR COPYRIGHT HOLDERS BE LIABLE FOR ANY CLAIM, DAMAGES OR OTHER LIABILITY, WHETHER IN AN ACTION OF CONTRACT, TORT OR OTHERWISE, ARISING FROM, OUT OF OR IN CONNECTION WITH THE SOFTWARE OR THE USE OR OTHER DEALINGS IN THE SOFTWARE.

Exhibit (f)

```
/*
 * Copyright (c) 1993
 * The Regents of the University of California. All rights reserved.
 *
 * Redistribution and use in source and binary forms, with or without
 * modification, are permitted provided that the following conditions
 * are met:
 * 1. Redistributions of source code must retain the above copyright
 * notice, this list of conditions and the following disclaimer.
 * 2. Redistributions in binary form must reproduce the above copyright
 * notice, this list of conditions and the following disclaimer in the
 * documentation and/or other materials provided with the distribution.
 * 3. All advertising materials mentioning features or use of this software
 * must display the following acknowledgment:
 * This product includes software developed by the University of
 * California, Berkeley and its contributors.
 * 4. Neither the name of the University nor the names of its contributors
 * may be used to endorse or promote products derived from this software
 * without specific prior written permission.
 *
 * THIS SOFTWARE IS PROVIDED BY THE REGENTS AND CONTRIBUTORS "AS IS" AND
 * ANY EXPRESS OR IMPLIED WARRANTIES, INCLUDING, BUT NOT LIMITED TO, THE
 * IMPLIED WARRANTIES OF MERCHANTABILITY AND FITNESS FOR A PARTICULAR PURPOSE
 * ARE DISCLAIMED. IN NO EVENT SHALL THE REGENTS OR CONTRIBUTORS BE LIABLE
 * FOR ANY DIRECT, INDIRECT, INCIDENTAL, SPECIAL, EXEMPLARY, OR CONSEQUENTIAL
 * DAMAGES (INCLUDING, BUT NOT LIMITED TO, PROCUREMENT OF SUBSTITUTE GOODS
 * OR SERVICES; LOSS OF USE, DATA, OR PROFITS; OR BUSINESS INTERRUPTION)
 * HOWEVER CAUSED AND ON ANY THEORY OF LIABILITY, WHETHER IN CONTRACT, STRICT
 * LIABILITY, OR TORT (INCLUDING NEGLIGENCE OR OTHERWISE) ARISING IN ANY WAY
 * OUT OF THE USE OF THIS SOFTWARE, EVEN IF ADVISED OF THE POSSIBILITY OF
 * SUCH DAMAGE.
 */
```

Exhibit (g)

Apache License  
Version 2.0, January 2004  
<http://www.apache.org/licenses/>

TERMS AND CONDITIONS FOR USE, REPRODUCTION, AND DISTRIBUTION

1. Definitions.

"License" shall mean the terms and conditions for use, reproduction, and distribution as defined by Sections 1 through 9 of this document.

"Licensor" shall mean the copyright owner or entity authorized by the copyright owner that is granting the License.

"Legal Entity" shall mean the union of the acting entity and all other entities that control, are controlled by, or are under common control with that entity. For the purposes of this definition, "control" means (i) the power, direct or indirect, to cause the direction or management of such entity, whether by contract or otherwise, or (ii) ownership of fifty percent (50%) or more of the outstanding shares, or (iii) beneficial ownership of such entity.

"You" (or "Your") shall mean an individual or Legal Entity exercising permissions granted by this License.

"Source" form shall mean the preferred form for making modifications, including but not limited to software source code, documentation source, and configuration files.

"Object" form shall mean any form resulting from mechanical transformation or translation of a Source form, including but not limited to compiled object code, generated documentation, and conversions to other media types.

"Work" shall mean the work of authorship, whether in Source or Object form, made available under the License, as indicated by a copyright notice that is included in or attached to the work (an example is provided in the Appendix below).

"Derivative Works" shall mean any work, whether in Source or Object form, that is based on (or derived from) the Work and for which the editorial revisions, annotations, elaborations, or other modifications represent, as a whole, an original work of authorship. For the purposes of this License, Derivative Works shall not include works that remain separable from, or merely link (or bind by name) to the interfaces of, the Work and Derivative Works thereof.

"Contribution" shall mean any work of authorship, including the original version of the Work and any modifications or additions to that Work or Derivative Works thereof, that is intentionally submitted to Licensor for inclusion in the Work by the copyright owner or by an individual or Legal Entity authorized to submit on behalf of the copyright owner. For the purposes of this definition, "submitted" means any form of electronic, verbal, or written communication sent to the Licensor or its representatives, including but not limited to communicating on a mailing list, source code control systems, and issue tracking systems that are managed by, or on behalf of, the Licensor for the purpose of discussing and improving the Work, but excluding communication that is conspicuously marked or otherwise designated in writing by the copyright owner as "Not a Contribution."

"Contributor" shall mean Licensor and any individual or Legal Entity on behalf of whom a Contribution has been received by Licensor and subsequently incorporated within the Work.

2. Grant of Copyright License. Subject to the terms and conditions of this license, each Contributor hereby grants to You a perpetual, worldwide, non-exclusive, no-charge, royalty-free, irrevocable copyright license to reproduce, prepare Derivative Works of, publicly display, publicly perform, sublicense, and distribute the Work and such Derivative Works in Source or Object form.

3. Grant of Patent License. Subject to the terms and conditions of this license, each Contributor hereby grants to You a perpetual, worldwide, non-exclusive, no-charge, royalty-free, irrevocable (except as stated in this section) patent license to make, have made, use, offer to sell, sell, import, and otherwise transfer the Work, where such license applies only to those patent claims licensable by such Contributor that are necessarily infringed by their Contribution(s) alone or by combination(s) of their Contribution(s) with the Work to which such Contribution(s) was submitted. If You institute patent litigation against any entity (including a cross-claim or counterclaim in a lawsuit) alleging that the Work or a Contribution incorporated within the Work constitutes direct or contributory patent infringement, then any patent licenses granted to You under this license for that Work shall terminate as of the date such litigation is filed.

4. Redistribution. You may reproduce and distribute copies of the Work or Derivative Works thereof in any medium, with or without modifications, and in Source or Object form, provided that You meet the following conditions:

- (a) You must give any other recipients of the Work or Derivative Works a copy of this License; and
- (b) You must cause any modified files to carry prominent notices stating that You changed the files; and
- (c) You must retain, in the Source form of any Derivative Works that You distribute, all copyright, patent, trademark, and attribution notices from the Source form of the Work, excluding those notices that do not pertain to any part of the Derivative Works; and
- (d) If the Work includes a "NOTICE" text file as part of its distribution, then any Derivative Works that You distribute must include a readable copy of the attribution notices contained within such NOTICE file, excluding those notices that do not pertain to any part of the Derivative Works, in at least one of the following places: within a NOTICE text file distributed as part of the Derivative Works; within the Source form or documentation, if provided along with the Derivative Works; or within a display generated by the Derivative Works, if and wherever such third-party notices normally appear. The contents of the NOTICE file are for informational purposes only and do not modify the License. You may add Your own attribution notices within Derivative Works that You distribute, alongside or as an addendum to the NOTICE text from the Work, provided that such additional attribution notices cannot be construed as modifying the License.

You may add Your own copyright statement to Your modifications and may provide additional or different license terms and conditions for use, reproduction, or distribution of Your modifications, or for any such Derivative Works as a whole, provided Your use, reproduction, and distribution of the Work otherwise complies with the conditions stated in this License.

5. Submission of Contributions. Unless You explicitly state otherwise, any Contribution intentionally submitted for inclusion in the Work by You to the Licensor shall be under the terms and conditions of this License, without any additional terms or conditions.

Notwithstanding the above, nothing herein shall supersede or modify the terms of any separate license agreement you may have executed with Licensor regarding such Contributions.

6. Trademarks. This License does not grant permission to use the trade names, trademarks, service marks, or product names of the Licensor, except as required for reasonable and customary use in describing the origin of the Work and reproducing the content of the NOTICE file.

7. Disclaimer of Warranty. Unless required by applicable law or agreed to in writing, Licensor provides the Work (and each Contributor provides its Contributions) on an "AS IS" BASIS, WITHOUT WARRANTIES OR CONDITIONS OF ANY KIND, either express or implied, including, without limitation, any warranties or conditions of TITLE, NON-INFRINGEMENT, MERCHANTABILITY, or FITNESS FOR A PARTICULAR PURPOSE. You are solely responsible for determining the appropriateness of using or redistributing the Work and assume any risks associated with Your exercise of permissions under this License.

8. Limitation of Liability. In no event and under no legal theory, whether in tort (including negligence), contract, or otherwise, unless required by applicable law (such as deliberate and grossly negligent acts) or agreed to in writing, shall any Contributor be liable to You for damages, including any direct, indirect, special, incidental, or consequential damages of any character arising as a result of this License or out of the use or inability to use the Work (including but not limited to damages for loss of goodwill, work stoppage, computer failure or malfunction, or any and all other commercial damages or losses), even if such Contributor has been advised of the possibility of such damages.

9. Accepting Warranty or Additional Liability. While redistributing the Work or Derivative Works thereof, You may choose to offer, and charge a fee for, acceptance of support, warranty, indemnity, or other liability obligations and/or rights consistent with this License. However, in accepting such obligations, You may act only on Your own behalf and on Your sole responsibility, not on behalf of any other Contributor, and only if You agree to indemnify, defend, and hold each Contributor harmless for any liability incurred by, or claims asserted against, such Contributor by reason of your accepting any such warranty or additional liability.

END OF TERMS AND CONDITIONS

APPENDIX: How to apply the Apache License to your work.

To apply the Apache License to your work, attach the following boilerplate notice, with the fields enclosed by brackets "[]" replaced with your own identifying information. (Don't include the brackets!) The text should be enclosed in the appropriate comment syntax for the file format. We also recommend that a file or class name and description of purpose be included on the same "printed page" as the copyright notice for easier identification within third-party archives.

Copyright [yyyy] [name of copyright owner]

Licensed under the Apache License, Version 2.0 (the "License"); you may not use this file except in compliance with the License. You may obtain a copy of the License at

<http://www.apache.org/licenses/LICENSE-2.0>

Unless required by applicable law or agreed to in writing, software distributed under the License is distributed on an "AS IS" BASIS, WITHOUT WARRANTIES OR CONDITIONS OF ANY KIND, either express or implied. See the License for the specific language governing permissions and limitations under the License.

## Exhibit (h)

\* Copyright (c) 2016~2018 MediaTek Inc.

\*

\* This program is free software; you can redistribute it and/or modify it under the terms of the GNU General Public License version 2 as published by the Free Software Foundation.

\*

\* This program is distributed in the hope that it will be useful, but WITHOUT ANY WARRANTY; without even the implied warranty of MERCHANTABILITY or FITNESS FOR A PARTICULAR PURPOSE. See <http://www.gnu.org/licenses/gpl-2.0.html> for more details.

\*/

# こんな場合は故障ではありません

## 悪天候でのBS・110度CSデジタル放送の受信障害

- 降雨や降雪などで電波が弱くなったときには、映像にノイズが多くなったり、映らなくなったりすることがあります。
- 天候が回復すれば正常に映るようになります。

大雪がふっている



大雨がふっている



アンテナに雪が積もっている



アンテナ接続か受信環境に問題があるためご覧になれません。  
ケーブルをつなぎ直すかアンテナ再調整などをしてください。

● ボタンでアンテナレベルをご確認ください。

コード：E202

### 本機内部からの動作音

- 電源待機時に番組情報を取得等の動作を開始する際「カチッ」という音が聞こえることがあります。
- 「ジー」という液晶/パネルの駆動音が聞こえることがあります。

### キャビネットからの「ピシッ」というきしみ音

- 「ピシッ」というきしみ音は、部屋の温度変化でキャビネットが伸縮するときに発生する音です。画面や音声等に異常がなければ心配ありません。

### 使用していないのに温まる

- 使用していない場合でも、番組情報取得等の動作をしている時等は、本機の温度が多少上昇します。

## 症状に合わせて解決法を調べる

- テレビが正しく動作しないなどの症状があるときは、以降の記載内容から解決法をお調べください。
- 解決法の対処をしても症状が改善されない場合は、電源プラグをコンセントから抜き、お買い上げの販売店にご相談ください。

### テレビが操作できなくなったとき - テレビをリセットする

- リモコンでもテレビ本体の操作ボタンでも操作できなくなった場合は、以下の操作を試してみてください。

#### 電源プラグを抜いてリセットする

1. 電源プラグをコンセントから抜いてください。
2. 1分間以上お待ちください。
3. 電源プラグをコンセントに差し込んで、電源をいれます。

#### 本体の電源ボタンを長押ししてリセットする

1. テレビ本体の電源ボタンを押し続けます。
2. 本体中央の「電源」の表示ランプが点滅したら、電源ボタンから手を離します。
3. しばらくすると電源が「入」になり、画面に「リセット機能により、再起動しました。」が表示されます。



# 症状に合わせて解決法を調べる (つづき)

## ▶ 操作

### 電源が入らない

| 確認すること              | 解決法・その他                                                        | ページ |
|---------------------|----------------------------------------------------------------|-----|
| 電源プラグが抜けていませんか。     | ・電源プラグをコンセントに差し込みます。                                           | —   |
| 「電源」表示が消えていませんか。    | ・本体の電源ボタンを押して電源を入れます。<br>※「電源」表示が消えているときは、リモコンで電源を入れることはできません。 | —   |
| 「電源」表示が赤色に点滅していますか。 | ・電源プラグをコンセントから抜き、1分以上たってからもう一度コンセントに差し込みます。                    | —   |

### リモコンが操作できない

| 確認すること                           | 解決法・その他                                            | ページ |
|----------------------------------|----------------------------------------------------|-----|
| リモコンとテレビ本体のリモコン受光部の間に障害物はありませんか。 | ・障害物を取り除きます。<br>リモコン受光部の位置本体全面の右下にございます。           | —   |
| リモコンの乾電池が消耗していませんか。              | ・新しい乾電池に交換します。                                     | —   |
| リモコンの乾電池の向き(+)、(-)が合っていますか。      | ・向き(+)、(-)を確認し、正しく入れてください。                         | —   |
| 本体のボタンは操作ができますか。                 | ・上記の方法を対処した上で、なおもリモコンだけで操作ができない場合は、リモコンの故障が考えられます。 | —   |

## ▶ 映像

### 放送の映像が出ない、またはきれいに映らない

| 確認すること                            | 解決法・その他                                                     | ページ |
|-----------------------------------|-------------------------------------------------------------|-----|
| アンテナ線がはずれていたり、切れていたり、ショートしていませんか。 | ・アンテナ線を確認して正しく接続します。<br>※屋外の接続については、販売店にご相談ください。            | —   |
| アンテナ線プラグの芯線が曲がっていませんか。            | ・確認して、まっすぐにします。(折らないようにご注意ください)                             | —   |
| アンテナ線プラグの芯線が折れたり、短くなっていたりしていませんか。 | ・アンテナ線を交換します。                                               | —   |
| レコーダーなどを経由してアンテナ線を接続していませんか。      | ・アンテナ線を本機に直接接続して映像が出る場合は、本機の故障ではありません。<br>・アンテナ線を分配して接続します。 | —   |
| 電波が弱くありませんか。                      | ・アンテナレベルを確認します。<br>・アンテナの向きを調節してみます。(販売店にご相談ください)           | 112 |
| アンテナ線の差込みがゆるんでいたたり、接触不良になっていませんか。 | ・確認して、しっかりと接続します。                                           | —   |
| アンテナ線(端子)がさびていませんか。               | ・販売店にご相談ください。                                               | —   |

### 接続した機器の映像が出ない、またはきれいに映らない

| 確認すること              | 解決法・その他                                  | ページ |
|---------------------|------------------------------------------|-----|
| 機器が正しく接続されていますか。    | ・確認して正しく接続します。                           | 69  |
| 機器の電源が入っていますか。      | ・機器の電源を入れます。                             | —   |
| 接続した機器の入力に切り換えましたか。 | ・リモコンの <b>入力切替</b> で、外部機器を接続した入力端子を選びます。 | 82  |

# 症状に合わせて解決法を調べる (つづき)

## 画面が暗い、または暗くなる時がある



| 確認すること                          | 解決法・その他                                                                                                             | ページ        |
|---------------------------------|---------------------------------------------------------------------------------------------------------------------|------------|
| 部屋の明るさに合った適切な映像メニューや調節になっていますか。 | <ul style="list-style-type: none"> <li>・明るい部屋では、「あざやか」を選択してみます。</li> <li>・「バックライト」や「明るさ調整」で適切な明るさに調整します。</li> </ul> | 102<br>103 |

## 色がおかしい

| 確認すること                   | 解決法・その他                                                                                                             | ページ |
|--------------------------|---------------------------------------------------------------------------------------------------------------------|-----|
| お好みの映像メニューや映像調整になっていますか。 | <ul style="list-style-type: none"> <li>・視聴している番組や映像に合わせて、お好みの映像メニューを選択します。</li> <li>・お好みの映像に調整することもできます。</li> </ul> | 102 |

## ▶ 音声

### 音声がでない

| 確認すること               | 解決法・その他                                                                                                                                                                                                                                                       | ページ |
|----------------------|---------------------------------------------------------------------------------------------------------------------------------------------------------------------------------------------------------------------------------------------------------------|-----|
| 音量が最小になっていませんか。      | <ul style="list-style-type: none"> <li>・  で音量を上げます。</li> </ul>                                                                                                               | 12  |
| 画面に消音マークが表示されていませんか。 | <ul style="list-style-type: none"> <li>・  を押すと消音を解除できます。</li> <li>・  (でも解除されます)</li> </ul> | 12  |
| 「外部スピーカー」になっていませんか。  | <ul style="list-style-type: none"> <li>・ サブメニューの「スピーカー切替」で「テレビのスピーカー」に設定します。</li> </ul>                                                                                                                                                                       | 36  |

## ▶ 地上デジタル放送

### 地上デジタル放送が映らない、または映像が乱れる

| 確認すること                                        | 解決法・その他                                                                                                                                                                    | ページ |
|-----------------------------------------------|----------------------------------------------------------------------------------------------------------------------------------------------------------------------------|-----|
| アンテナレベルが推奨値以下ではありませんか。                        | <ul style="list-style-type: none"> <li>・ サブメニューの「その他の操作」の「アンテナレベル表示」でアンテナレベルを確認します。</li> <li>※推奨値よりも低い場合は、放送を受信できない場合があります。お買い上げの販売店にご相談の上、アンテナの向きを確認・調整してください。</li> </ul> | 112 |
| 「初期スキャン」をしましたか。                               | <ul style="list-style-type: none"> <li>・ 「初期スキャン」をします。</li> </ul>                                                                                                          | 115 |
| お住まいの地域は地上デジタル放送の受信可能エリアですか。                  | <ul style="list-style-type: none"> <li>・ 社団法人デジタル放送推進協会のホームページ (<a href="http://www.dpa.or.jp/">www.dpa.or.jp/</a>) で確認することもできます。</li> </ul>                               | —   |
| 共聴システムやCATVをご利用の場合、地上デジタル放送のパススルー方式に対応していますか。 | <ul style="list-style-type: none"> <li>・ CATVの場合はご契約のCATV会社に、その他の場合は共聴システムの管理者にお問い合わせください。(CATVがパススルー方式でない場合はCATV用チューナーが必要な場合があります)</li> </ul>                             | —   |

### 引越しをしたら、地上デジタル放送が映らなくなった

| 確認すること                        | 解決法・その他                                                                                                             | ページ |
|-------------------------------|---------------------------------------------------------------------------------------------------------------------|-----|
| 引越し後「初期スキャン」または「再スキャン」をしましたか。 | <ul style="list-style-type: none"> <li>・ 県外に引越しをした場合は、「初期スキャン」をします。</li> <li>・ 県外に引越しをした場合は、「再スキャン」をします。</li> </ul> | 115 |

## ▶ BS・110度CSデジタル放送

### BS・110度CSデジタル放送が映らない、または映像が乱れる

| 確認すること                                                                      | 解決法・その他                                                                                                                                                                                                                    | ページ |
|-----------------------------------------------------------------------------|----------------------------------------------------------------------------------------------------------------------------------------------------------------------------------------------------------------------------|-----|
| アンテナ接続に分配器を使用していますか。                                                        | ・分配器は「全端子通電型」のものを使用します。                                                                                                                                                                                                    | —   |
| 有料放送ではありませんか。                                                               | ・有料放送を視聴するには契約が必要です。視聴の申込みや視聴料金などについては、放送事業者にご相談ください。<br>※同梱の「ファーストステップガイド」をご覧ください。                                                                                                                                        | —   |
| マンションなどで、壁のアンテナ端子が1つだけになっていますか。                                             | ・視聴できる放送の種類について、マンションなどの管理会社にご確認ください。<br>・ご自身で確認する場合は、アンテナ線を本機のBS・110度CSアンテナ入力端子に直接接続してみます。(地上デジタル放送を確認する場合は、地上デジタルアンテナ入力端子へ)<br>・BS・110度CSデジタル放送と地上デジタル放送の両立が受信できる場合は、分波器を使用してアンテナ線をBS・110度アンテナ入力端子と地上デジタルアンテナ入力端子に接続します。 | —   |
| テレビまたはアンテナ線の近くで携帯電話、スマートフォン、コードレス電話、Wi-Fi機器(アクセスポイントを含む)などの無線機器を使用していないですか。 | ・左記の機器は、テレビまたはアンテナ線から離れて使用してください。映像・音声不乱れる場合があります。                                                                                                                                                                         | —   |

## ▶ 番組表

### 番組表に内容が表示されない

| 確認すること          | 解決法・その他                                        | ページ     |
|-----------------|------------------------------------------------|---------|
| 電源プラグを抜いていませんか。 | ・電源プラグをコンセントに差し込んでおきます。<br>・「番組表を更新する」の操作をします。 | —<br>19 |

### 番組表の文字が小さい

| 確認すること | 解決法・その他                                                                                                                | ページ |
|--------|------------------------------------------------------------------------------------------------------------------------|-----|
| —      | ・番組表を表示中に  を押して、文字の大きさを変更することができます。 | 20  |

### 放送局のすべてのチャンネルが表示されない

| 確認すること                          | 解決法・その他                    | ページ |
|---------------------------------|----------------------------|-----|
| 「1チャンネル表示」にいませんか。               | ・番組表のサブメニューで「マルチ表示」を選択します。 | 19  |
| 「チャンネルスキップ設定」で「スキップ」に設定していませんか。 | ・「チャンネルスキップ設定」で「受信」に設定します。 | 116 |

## ▶ お知らせアイコンが消えない

| 確認すること             | 解決法・その他                                                              | ページ |
|--------------------|----------------------------------------------------------------------|-----|
| 「お知らせ」の内容を確認しましたか。 | ・サブメニューの「その他の操作」⇒「お知らせ」で内容を確認します。<br>※未読のお知らせが1件でも残っていると、アイコンは消えません。 | 124 |

# 本機で使われるソフトウェアライセンス情報 (つづき)

## ▶ 録画・再生

### USB ハードディスクが使用できない (認識されない)

| 確認すること                            | 解決法・その他                                                                                                                                                                                                                                                                                                                   | ページ |
|-----------------------------------|---------------------------------------------------------------------------------------------------------------------------------------------------------------------------------------------------------------------------------------------------------------------------------------------------------------------------|-----|
| 本機で接続確認済のUSBハードディスクですか。           | <ul style="list-style-type: none"> <li>本機で接続確認済のUSBハードディスクはホームページでお知らせ (<a href="http://www.marshall-no1.jp/support/index.html">http://www.marshall-no1.jp/support/index.html</a>)</li> <li>※本機で接続確認済の機器でない場合は、使用できないことがあります。</li> <li>※接続確認済の機器でも機器の状態によって使用できない場合があります。</li> </ul>                                      | —   |
| 機器が正しく接続されていますか。                  | <ul style="list-style-type: none"> <li>「USBハードディスクを接続する」に従って、正しく接続します。</li> </ul>                                                                                                                                                                                                                                         | 42  |
| 機器の電源がはいていますか。                    | <ul style="list-style-type: none"> <li>「USBハードディスクの電源を入れます。</li> <li>※USBハードディスクは専用のACアダプターを接続してご使用ください。</li> </ul>                                                                                                                                                                                                       | —   |
| 機器が本機に登録されていますか。                  | <ul style="list-style-type: none"> <li>「USBハードディスクを本機に登録します。</li> </ul>                                                                                                                                                                                                                                                   | 43  |
| USBハブを使用している場合、本機で使えるようになっていませんか。 | <ul style="list-style-type: none"> <li>「ホームページ (<a href="http://www.marshall-no1.jp/support/index.html">http://www.marshall-no1.jp/support/index.html</a>) で USB ハブが推奨機器であることを確認します。</li> <li>※推奨機器でない場合は使用できないことがあります。</li> <li>「USBハードディスクを接続する」の「お知らせ」をご覧ください。</li> <li>※USBハードディスクは専用のACアダプターを接続してご使用ください。</li> </ul> | —   |

### 録画ができない、または録画されなかった

| 確認すること                                   | 解決法・その他                                                                                                                                        | ページ      |
|------------------------------------------|------------------------------------------------------------------------------------------------------------------------------------------------|----------|
| USBハードディスクの残量が足りていますか。                   | <ul style="list-style-type: none"> <li>残量を確認する。</li> <li>不要な番組を削除する。</li> <li>「自動削除設定」を「削除する」に変更する。</li> </ul>                                 | 63<br>64 |
| コピー禁止の番組ではありませんか                         | <ul style="list-style-type: none"> <li>録画はできません。</li> </ul>                                                                                    | —        |
| 外部入力からの番組、独立データ放送番組、外部機器からの映像などではありませんか。 | <ul style="list-style-type: none"> <li>本機は先の番組や映像の録画には対応しておりません。</li> </ul>                                                                    | —        |
| 予約した番組の放送時間が繰り上げられませんでしたか。               | <ul style="list-style-type: none"> <li>本機は放送時間が繰り上げられた番組の録画はできません。</li> <li>※「詳細設定」の「放送時間」を「連動する」に設定した場合でも、放送時間の繰り上げには対応できません。</li> </ul>      | 53       |
| 連ドラ予約の場合、「追跡基準」、「追跡キーワード」は正しく設定されていますか。  | <ul style="list-style-type: none"> <li>「詳細設定」で「追跡キーワード」を正しく設定します。</li> <li>※1回限りのキーワード（「第〇〇話」や出演者名など）を削除します。</li> </ul>                        | 53       |
| 「お知らせ」のアイコンが表示されていませんか。                  | <ul style="list-style-type: none"> <li>サブメニューの「その他の操作」⇒「お知らせ」で内容を確認します。</li> <li>※番組の重複や、放送時間の変更などで録画できなかった場合は、「本機に関するお知らせ」が発行されます。</li> </ul> | 124      |

### 録画した番組が消えた

| 確認すること                       | 解決法・その他                                                                                                                                                                             | ページ |
|------------------------------|-------------------------------------------------------------------------------------------------------------------------------------------------------------------------------------|-----|
| 「自動削除設定」が「削除する」になっていませんか。    | <ul style="list-style-type: none"> <li>「自動削除設定」を「削除しない」に設定する。</li> <li>または、消したくない番組を保護する。</li> </ul>                                                                                | 64  |
| 録画中に電源プラグや接続ケーブルを抜きましたか。     | <ul style="list-style-type: none"> <li>録画中や録画設定をしたときは電源プラグを抜かない。</li> <li>※左記の場合、録画中の番組は残りません。また、録画したすべての番組が消えることがあります。</li> <li>「録画番組修復する」の操作をすれば、録画された内容を再生できるようになります。</li> </ul> | 60  |
| 録画リストの分類タブが「すべて」以外になっていませんか。 | <ul style="list-style-type: none"> <li>録画リストの分類タブを &lt;&lt; &gt;&gt; で「すべて」に変更する。</li> <li>※分類タブが「未視聴」の場合は、一度でも再生した録画番組は、リストに表示されません。</li> </ul>                                    | 57  |

# 壁掛けでご利用になるとき

本機は市販の壁掛け金具を使用して、壁に取り付けることができます。

## ⚠ 注意

- テレビを取り付ける壁の強度は十分ご注意ください。
- 壁掛け金具の取り付けは、必ず専門の業者にご依頼ください。
- 専門業者以外の方が取り付けたり、壁への取り付けが不適切な場合、テレビが落下して打撲や大けがの原因となることがあります。

背面イメージ (JU50TS01)

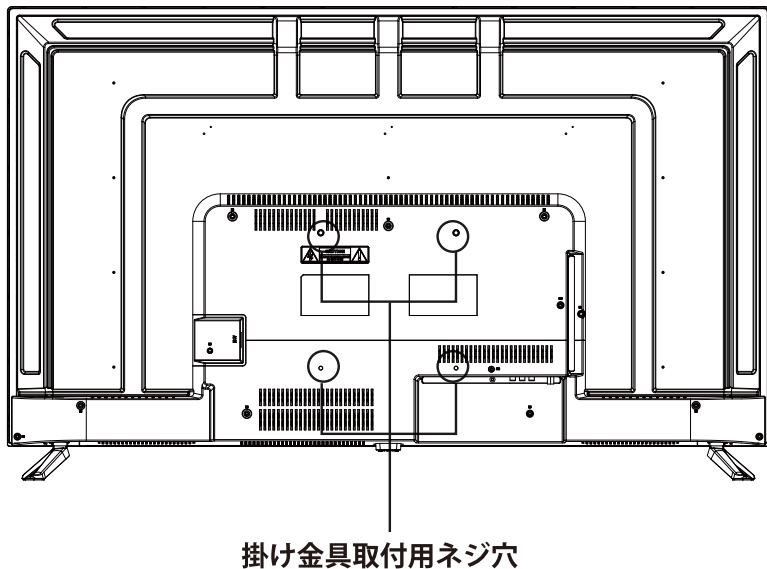

壁掛けネジ穴寸法 (VESA規格) :  
JU50TS01 (H200mm×W200mm)

壁掛け用ねじ :  
JU50TS01 M6×10mm(4本)

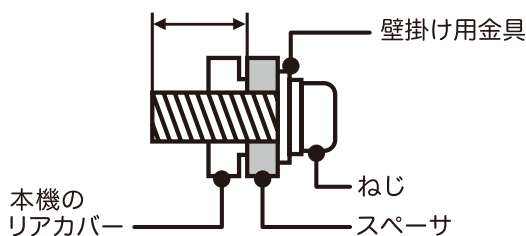

ご注意.....  
長いネジをご使用になると内部の部品へダメージを与え製品を損傷します。

## スタンドのはずしかた

本機を壁掛けでご利用になるときは、スタンドをはずしてください。

- 1 テーブルなどの台の上に毛布などのやわらかい布を敷き、その上に液晶画面を下向きにして本機を置く。
- 2 スタンド固定用ネジを取りはずし、スタンドを本体の下方方向に引いて外します。

【スタンドを外すイメージ】

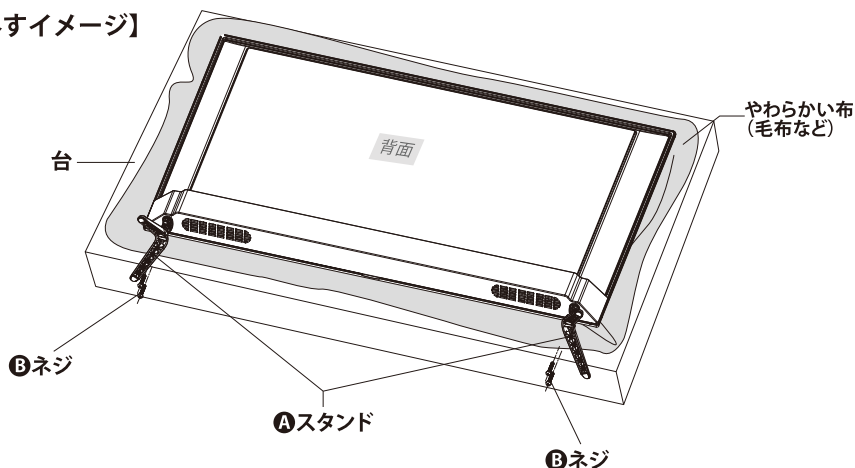

液晶パネルを傷つけないように取り扱いしてください。はずしたネジは、再度スタンドを取り付ける場合に必要です。スタンドと共に保管してください。

# 主な仕様 (テレビ)

|             |                                                                                                               |                                                                                                                 |
|-------------|---------------------------------------------------------------------------------------------------------------|-----------------------------------------------------------------------------------------------------------------|
| 型番          | JU50TS01                                                                                                      |                                                                                                                 |
| 電源          | AC 100V～ 50/60Hz                                                                                              |                                                                                                                 |
| 種類          | 地上・BS・110度CS対応液晶テレビ                                                                                           |                                                                                                                 |
| 液晶パネル       | 画面サイズ                                                                                                         | 50インチ                                                                                                           |
|             | バックライト                                                                                                        | LED直下型バックライト                                                                                                    |
|             | 駆動方式                                                                                                          | VA                                                                                                              |
|             | 画素数                                                                                                           | 3840(H)×2160(V)                                                                                                 |
|             | 応答速度                                                                                                          | 8ms                                                                                                             |
|             | 視野角(最小値)                                                                                                      | 左右約 170°/上下約 170°                                                                                               |
|             | 輝度(最大値)                                                                                                       | 250cd/m <sup>2</sup>                                                                                            |
|             | コントラスト比(標準値)                                                                                                  | 6000:1                                                                                                          |
| 地上波デジタル     | 地上デジタル:UHF(13～62ch) CATVパススルー:(VHF,UHF)対応共有                                                                   |                                                                                                                 |
| BSデジタル      | BSデジタル:BS000～BS999                                                                                            |                                                                                                                 |
| 110度CSデジタル  | 110度CSデジタル:CS000～CS999                                                                                        |                                                                                                                 |
| チューナー数      | 地上デジタル×2、BSデジタル×2、110度CSデジタル×2、4K BSデジタル×2、4K 110度CSデジタル×2                                                    |                                                                                                                 |
| 音声出力(スピーカー) | 8W+8W                                                                                                         |                                                                                                                 |
| 入力・出力端子     | ビデオ入力×1                                                                                                       | RCAピンジャック<br>映像:1V(p-p)、75Ω、同期負<br>音声:200mV(ms)、22KΩ以上                                                          |
|             | HDMI入力×4<br>(HDMI1はARC対応)                                                                                     | HDMI CEC対応 ARC対応<br>HDMI 対応入力解像度<br>480i.480p.720/60p. 1080/60i. 1080/24p. 1080/30p. 1080/60p.4K 24Hz/30Hz/60Hz |
|             | USB(録画専用)端子                                                                                                   | 録画専用×1 メディア/サービス用×1                                                                                             |
|             | LAN端子                                                                                                         | ×1                                                                                                              |
|             | 光デジタル音声出力端子                                                                                                   | ×1                                                                                                              |
|             | ヘッドホン出力                                                                                                       | ×1(3.5mmステレオミニジャック)                                                                                             |
| HDD録画機能     | 裏番組録画対応、番組表から録画予約可能、最大録画番組数3000、日時指定予約機能、放送時間連動機能、レギューム再生、追っかけ再生、頭出し再生、ワンタッチスキップ機能、HDD省エネ設定機能                 |                                                                                                                 |
| データ放送       | 双方向データ放送対応                                                                                                    |                                                                                                                 |
| 番組表         | 電子番組表(EPG)対応、8日分受信、視聴予約可能                                                                                     |                                                                                                                 |
| 使用環境/保管環境   | 温度:5℃～40℃、相対湿度:80%未満(結露のないこと)                                                                                 |                                                                                                                 |
| サイズ(W.H.D)  | (約)1126.5mm×650.1mm×93.5mm(スタンド含まず)<br>(約)1126.5mm×699.8mm×195.9mm(スタンド含む)                                    |                                                                                                                 |
| 重量          | 9.4kg(スタンド含む)                                                                                                 |                                                                                                                 |
| 消費電力        | 127W                                                                                                          |                                                                                                                 |
| 年間消費電力      | 150kWh                                                                                                        |                                                                                                                 |
| 付属品         | リモコン×1個、リモコン用単4乾電池×2個、取扱説明書(保証書)×1部、<br>スタンド×2個、スタンド固定ネジ×4個、スタンド取付説明書×1<br>※アンテナケーブルは付属しておりません。市販のものをご使用ください。 |                                                                                                                 |

# 主な仕様 (リモコン)

|          |                  |
|----------|------------------|
| 電源       | DC 3V(単4形乾電池 ×2) |
| リモコン操作距離 | 約 6m(但し直進)       |
| リモコン操作角度 | 左右 約30°          |

※製品使用は予告なく変更されることがあります。

※このテレビをご利用できるのは、日本国内のみで外国では使用できません。

## ご注意.....

同梱の乾電池は動作確認用です。動作確認後に新しい電池に交換してください。

# 保証とアフターサービス

## 基本的な取り扱い方法、故障と思われる場合のご確認

ホームページ上にも情報を掲載しておりますのでご覧ください。

[www.maxzen.jp](http://www.maxzen.jp)

## 故障と思われる場合のご相談について

この取扱説明書内にあります「故障かな?と思ったら」の内容や上記ホームページをチェックしても問題が解決できない場合、まず電源プラグを抜いてお買い上げの販売店もしくはマクスゼンテクニカルセンターまでご連絡ください。

**マクスゼンテクニカルセンター TEL:0570-099-455**

mail : [mtc@maxzen.jp](mailto:mtc@maxzen.jp) 受付時間 : 平日9:00~17:00 月曜~金曜日 (祝日を除く)

- お客様からご提供いただいた個人情報は、修理やご相談への回答、カタログ発送などの情報提供に利用いたします。
- 利用目的の範囲内で、当該製品に関連するグループ会社や協力会社にお客様の個人情報を提供する場合があります。

## 修理について

当社では原則的に出張修理を行っておりません。  
センドバック修理となりますので予めご了承ください。

## 部品について

修理のために取り外した部品は、特段のお申し出がない限り当社で引き取らせて頂きます。また、修理の際、当社の品質基準に適合した再利用部品を使用することがあります。

## 修理を依頼されるときは

### 保証期間中は

修理に関しては保証書をご覧ください。保証書の規定に従って販売店もしくはマクスゼンテクニカルセンターが修理をさせていただきます。

### 保証期間が過ぎているとき

修理をすれば使用出来ると思われる場合には、ご希望によって有料で修理させていただきます。

### 修理料金について

修理料金は、技術料・部品代・製品の送料などで構成されています。当社では原則的に出張修理は行っておりません。

|     |                        |
|-----|------------------------|
| 技術料 | 故障した製品を正常に修復するための料金です。 |
| 部品代 | 修理に使用した部品代金です。         |
| 送料  | 製品を修理会社まで運搬するための費用です。  |

**廃棄時にご注意願います。** 家電リサイクル法では、ご使用済の液晶テレビを廃棄する場合は、収集・運搬料金、再商品化等料金(リサイクル料金)をお支払いの上、対象品を販売店や市町村に適正に引き渡すことが求められています。



愛情点検

長年ご使用のテレビの点検をぜひ！ 熱、湿気、ホコリなどの影響や、使用の度合いによって部品が劣化し、故障したり、ときには安全性を損なって事故につながることもあります。

ご使用の際  
このような症状は  
ありませんか？

- 電源を入れても映像や音が出ない。
- 映像が時々、消えることがある。
- 変なにおいがしたり、煙が出たりする。
- 電源を切っても、映像や音が消えない。
- 内部に水や異物がはいった。

ご使用中

このような場合、故障や事故防止のため、すぐに電源プラグをコンセントから抜いて、必ずお買い上げの販売店に点検・修理をご相談ください。  
ご自分での修理は危険ですので、絶対にしないでください。



# 保証とアフターサービス (つづき)

## 保証書

- 保証期間はご購入日から1000日です。保証対象は機器本体のみです。  
(保証期間中でも有料修理になることがありますので、保証規定をよくお読みください)
- 保証期間中は保証規定に従い無料修理いたします。
- 保証期間が過ぎている時はご購入の販売店又はマクスゼンテクニカルセンターにご相談ください。修理によって機能が維持できる場合はご希望により有料修理いたします。

| 保証書      |            |                                     |
|----------|------------|-------------------------------------|
| 製品名      | 50型4K液晶テレビ | ご購入履歴を印刷いただき本書と一緒に保管してください          |
| 製品型番     | JU50TS01   |                                     |
| ご購入日     | 年 月 日      |                                     |
| 故障の状況    | できるだけ具体的に  |                                     |
| 接続している機器 |            |                                     |
| お名前      |            | 保証書のお買い上げ日については商品出荷日となります           |
| ご住所      |            | 保証書は再発行いたしませんので、紛失しないように大切に保管してください |
| 電話番号     |            |                                     |
|          |            | 販売店                                 |

## 保証規定

- 1.修理はご購入の販売店又はマクスゼンテクニカルセンターに必ず製品本体と保証書を提示の上、ご相談ください。
- 2.ご贈答、ご転居の際は、ご購入の販売店又はマクスゼンテクニカルセンターに必ず製品本体と保証書を提示の上、ご相談ください。また、保証書には、ご購入履歴を印刷いただき一緒にご提示ください。
- 3.次のような場合、保証中でも有料修理になります。

- ・火災、塩害、ガス害、地震、風水害、落雷等の天災地変による故障や損傷。
- ・指定以外の電圧を加えたことによる故障や損傷。
- ・ご購入後の落下、移動等運送上の破損及び取り付け時の破損や損傷。
- ・保証書の提示がない場合。
- ・保証書にお客様名、ご購入日、販売店名の記入がない、又は字句を書き換えられた場合。
- ・一般家庭用以外での業務用に使われた場合(本製品は一般家庭用であり業務用ではありません)
- ・使用上の誤り、及び不当な修理や改造による故障および損傷。
- ・不具合の原因が本製品以外(外部要因)による場合。
- ・車両、船舶等に搭載された場合に生ずる故障および損傷。
- ・オークションで落札された商品の場合。
- ・離島又は離島に準ずる遠隔地へ引取修理を行う場合の送料。

- 4.本書は日本国内においてのみ有効です。(This warranty is valid only in japan.)
- 5.保証書は再発行いたしませんので、大切に保管してください。

# MEMO

---

---

# MEMO

---

---

# MAXZEN

- 本製品には、保証書が付いています。ご購入の販売店名、ご購入年月日のご記入なきものは、無効となりますので必ずご確認ください。
- 本製品ならびに本書は、改善のために予告なく変更する場合があります。
  - 本書の内容の一部または全部の無断転載を禁じます。
- 本製品の使用・故障によって生じた、直接・間接の損害については、弊社はその責任を負わないものとします。
  - 乱丁本・落丁本の場合はお取り替えいたします。販売店、またはテクニカルセンターにご連絡ください。

**マクスゼンテクニカルセンター**

**TEL.0570-099-455**

受付時間：平日 9:00～17:00 月曜～金曜日(祝日を除く)

mail : [mtc@maxzen.jp](mailto:mtc@maxzen.jp)

Copyright ©MAXZEN.Inc All Rights Reserved.